



Shipping & Mailing
Postage Meters

SendPro® C Lite, SendPro® C

User Guide

New Zealand Edition
SV63242-nz Rev.B
22 June 2022

©2022 Pitney Bowes Inc.

All rights reserved. This book may not be reproduced in whole or in part in any fashion or stored in a retrieval system of any type or transmitted by any means, electronically or mechanically, without the express written permission of Pitney Bowes.

The use of this information by the recipient or others for purposes other than the training of customers on Pitney Bowes equipment may constitute an infringement of intellectual property rights of Pitney Bowes, and Pitney Bowes assumes no responsibility for any such use of the information.

We have made every reasonable effort to ensure the accuracy and usefulness of this manual. However, we cannot assume responsibility for errors or omissions or liability for the misuse or misapplication of our products.

Except as provided in writing, duly signed by an officer of Pitney Bowes, no license either express or implied, under any Pitney Bowes or third party's patent, copyright or other intellectual property rights is granted by providing this information.

PB Postage™ is a trademark of Pitney Bowes Inc.

Table of Contents

1 - Installation

Installing the SendPro C Lite, SendPro C	8
Installing the printhead	17
Installing a scale	21
Installing an external scale	22

2 - Connectivity

Setting up a wired network connection	27
Setting up a wireless (Wi-Fi) network connection	29
Connecting to a hidden Wi-Fi network	30
Forgetting a Wi-Fi network	32
Checking your network connection	34
Finding the MAC address for wired and wireless networks	34
Setting up a Proxy server	38

3 - Scales and Weighing

Using the scale when printing postage	42
Entering the weight manually when printing postage	42
Zeroing the scale	43

4 - Accounting

What is Accounting	46
Creating your first Envelope Printing account	47
Selecting an account	48
Editing an account	48

Making an account inactive	49
Deleting a Envelope Printing account	49

5 - Postage Funding

Checking the available funds for printing postage	52
Refilling postage funds for printing postage	53
Changing the default refill amount for printing postage	54
Setting the low funds warning for printing postage	55
Getting a New Zealand Post refund for damaged or incorrectly printed mail in Envelope Printing	56
Viewing the refill history for printing postage	56
Printing a funds report	56

6 - Mailing

Sending post by Standard Post	59
Key in Postage	59

7 - Sealing

Filling the moistener tank	61
Sealing envelopes when you print postage	61
Sealing envelopes without printing postage	63
Avoiding envelope sealing issues	64

8 - Printing

What are print modes	67
Printing a custom graphic	67
Printing a graphic without printing postage	68
Adding a custom text message	68
Adding an inscription	68
Printing only the date and time	69
Printing a test pattern	69

9 - Feeding and Jamming

Preventing envelope feeding problems	72
--	----

10 - Ink

Checking the ink level	75
Ordering ink cartridges	75
Replacing the ink cartridge	76

11 - History and Reports

Running account reports	79
Setting the report period for an account	79
Setting the account report preferences	80
Emailing an account report	81
Viewing the total spent on printing postage	83

12 - Settings

What are presets	85
Adding presets	85
Selecting a preset	86
Modifying presets	86
Setting the default preset reset timer	87
Using SendPro Apps	88
Adding favourite apps	89
Using the SendPro Care app	90
Using the Toolbar	90
Adjusting display brightness	91
Setting up the Energy Saver	91
Creating or disabling the security PIN	92
Adjusting time zone and scale location code	93
Advancing the date	93
Uploading postage transactions	94
Clearing or resetting the number of mailpieces sent	95

13 - Rate Change

Updating postal rates or software	97
---	----

14 - Maintenance

Cleaning the Printhead	100
Cleaning the moistener brush and wick assembly	100
Moving the SendPro C Lite, SendPro C	104
Ordering supplies	104

15 - Product Information

Navigating the Home screen	106
Navigating the Envelope Printing app	107
Parts of a meter stamp	108
Postal Security Device	108
Parts of the SendPro C Lite, SendPro C	109
Connections on the back	110
Specifications	110
Material specifications	113
Lithium ion battery	116
Agency compliance information	116
Scale Safety	118
Contacting Pitney Bowes	118
Third party software	119

1 - Installation

In this section

Installing the SendPro C Lite, SendPro C.....	8
Installing the printhead.....	17
Installing a scale.....	21
Installing an external scale.....	22

Installing the SendPro C Lite, SendPro C

If you are installing a SendPro C Lite, SendPro C for the very first time, follow these instructions.

1. *Before you begin*
2. *Open the box*
3. *Unpack the device*
4. *Install the printhead*
5. *Install the ink cartridge*
6. *Connect device to a power source*
7. *Continue installation steps*

1 Before you begin

Watch this video or follow the instructions below to learn how to install your device.

Before you begin installing your new SendPro C Lite, SendPro C, decide how you are going to pay for postage and what type of connection (wired or wireless) you want to use.

Pitney Bowes offers two ways to fund postage for Envelope Printing on your SendPro C Lite, SendPro C:

- A prepaid account with Pitney Bowes or
- A credit account with New Zealand Post.

You must choose one payment method. You cannot use credit cards.

Choose your connection type

Wired Connections 	Take about 10 minutes to set up Require an ethernet port and power outlet.
Wireless Connections 	Take about 15 minutes to set up Require access to a wireless network and power outlet.

2 Open the box

In the box you will find:

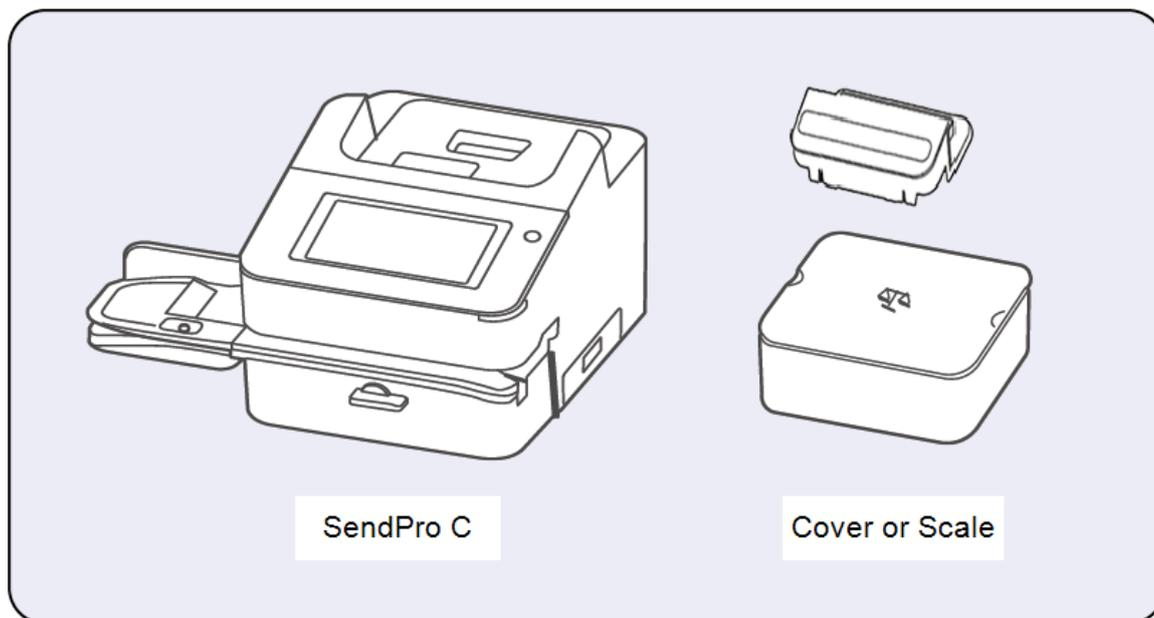

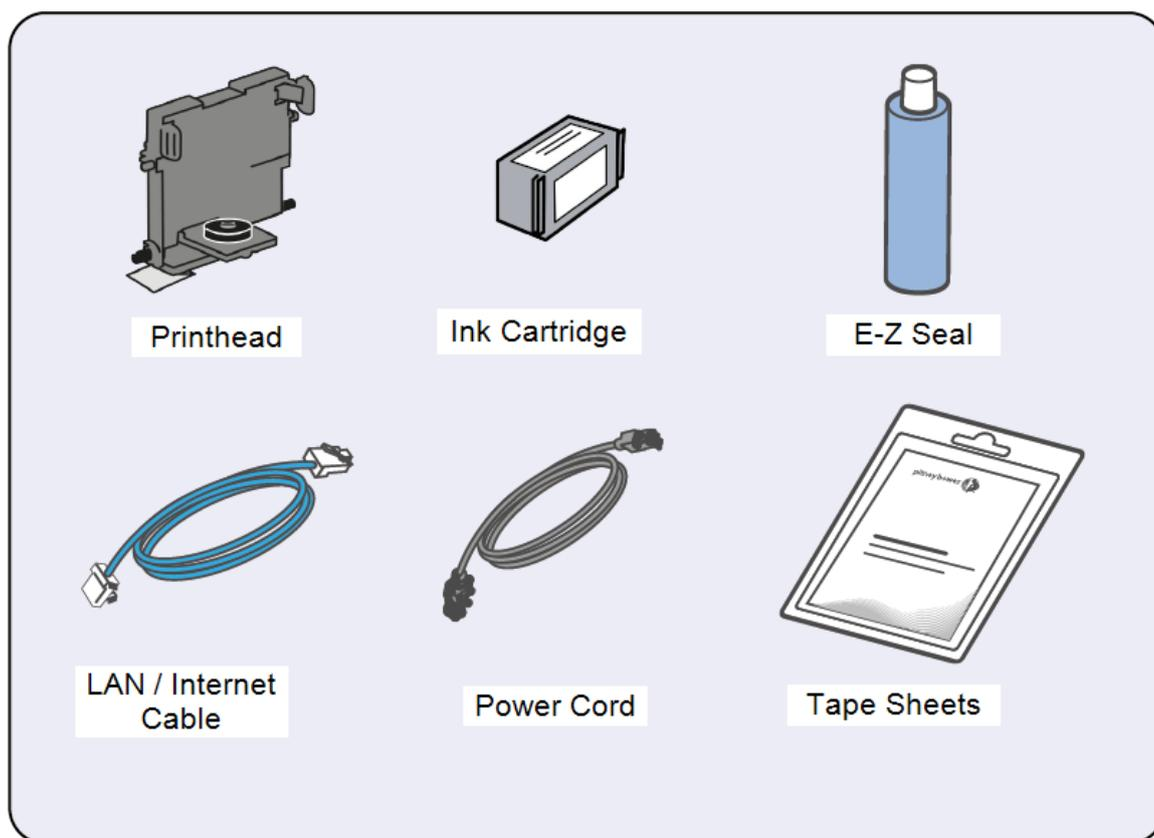

3 **Unpack the device**

1. Remove the device and all items from the box.



2. **Important:** Be sure to grab hold of the entire feeder, not just the moistener flap when lifting the device out of the box.



3. **Do not** connect your device to a power source yet.

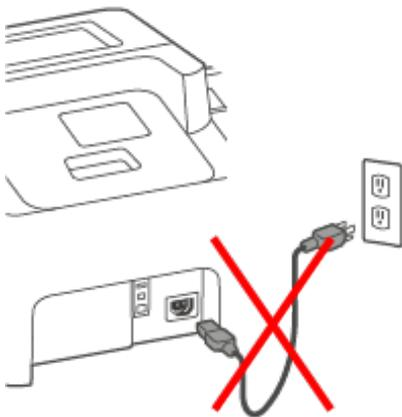

4. Remove all packing materials from the device.

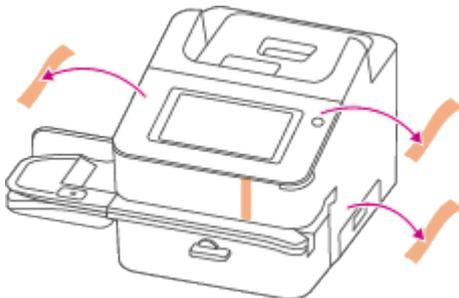

4 Install the printhead

1. Open the cover to access the ink carriage.

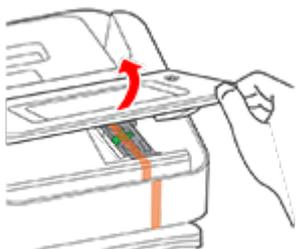

2. Remove the packing tape from the ink carriage.

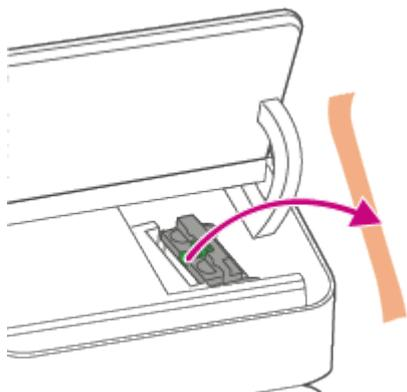

3. Open the ink carriage guard.

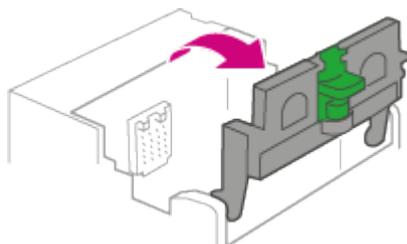

4. Unwrap the printhead and remove the protective strip.

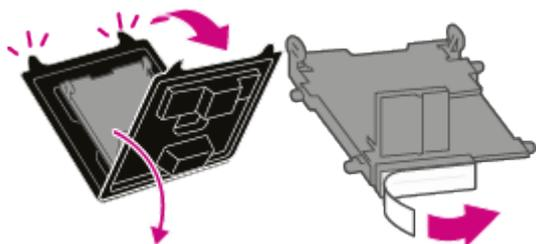

5. Squeeze the tabs and slide the printhead pegs into the lower set of grooves.
Important: This step is critical to prevent device damage.

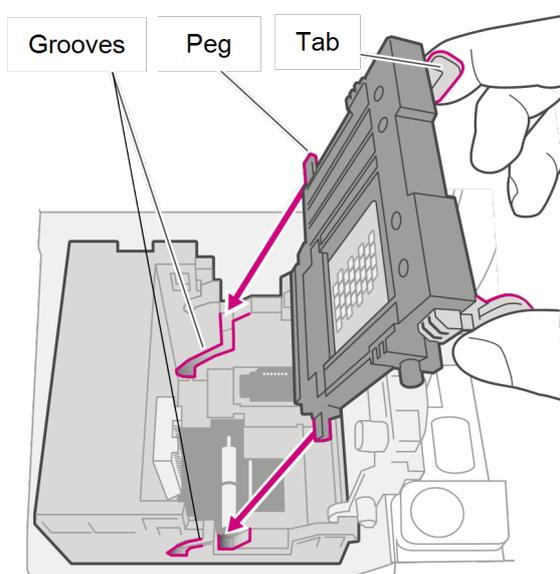

6. Keep squeezing the tabs and push the printhead flush against the wall. The tabs snap outward when you place the printhead correctly.

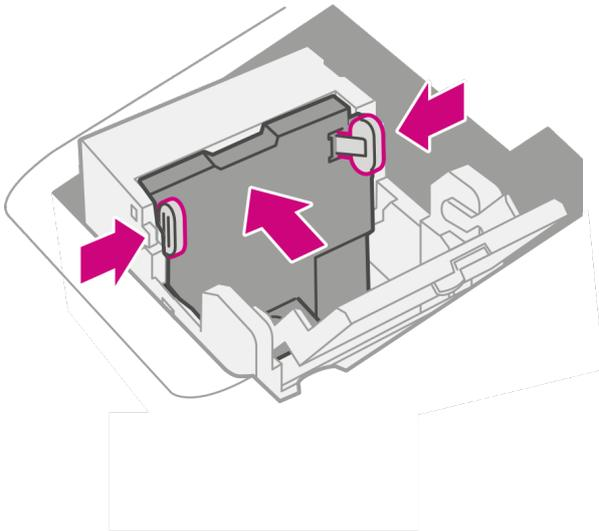

5 Install the ink cartridge

1. Unwrap the ink cartridge and remove the silver foil strip from the ink cartridge.

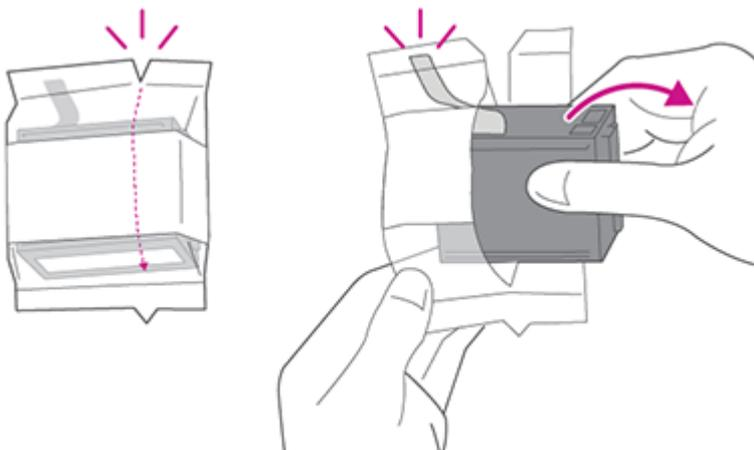

2. Install the ink cartridge and close the guard.

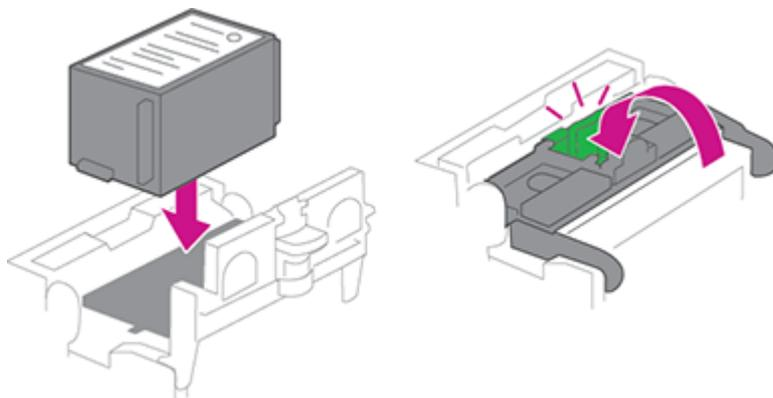

3. Close the cover.

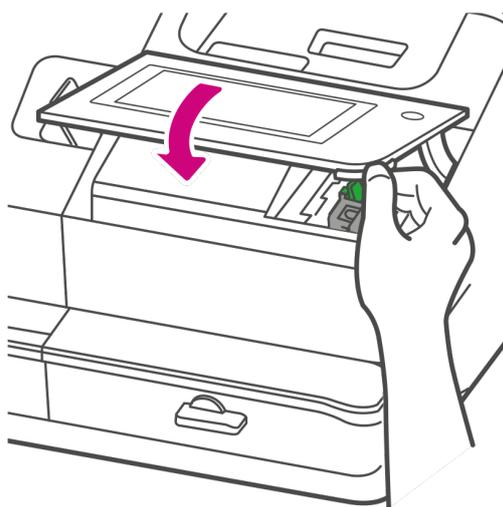

6 Connect the device to a power source

Connect the device to a power source. Tap the power button.

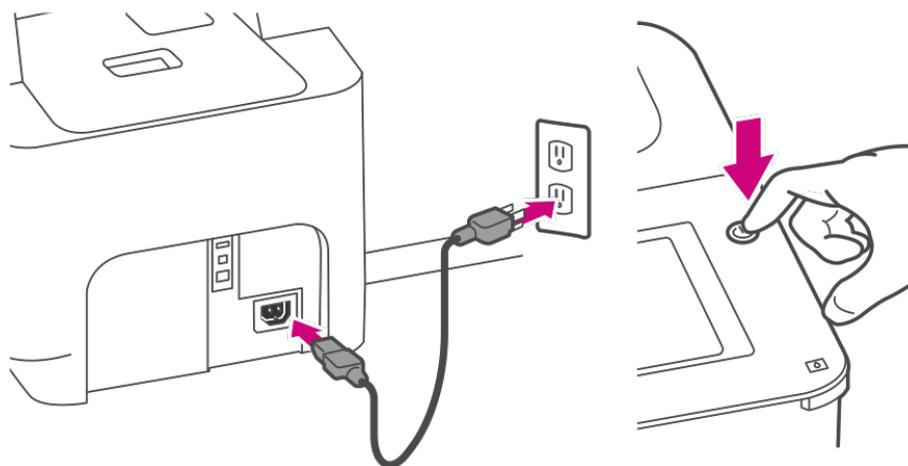

7 Follow the installation instructions on the device

1. Wait for the device to start up.
2. Tap **Get Started** on the touchscreen and continue the installation steps on the screen.



3. Tap **Got it** when you see the message "You're ready to start sending."

Installing the printhead

You may need to install a new printhead when the existing printhead is producing poor print quality.

1. Tap **Settings**.



2. Scroll down and tap Envelope Printer Maintenance.
3. Tap **Install Printhead**.
4. Lift the cover. The ink cartridge moves to the front position.
5. Flip the ink cartridge cover open.

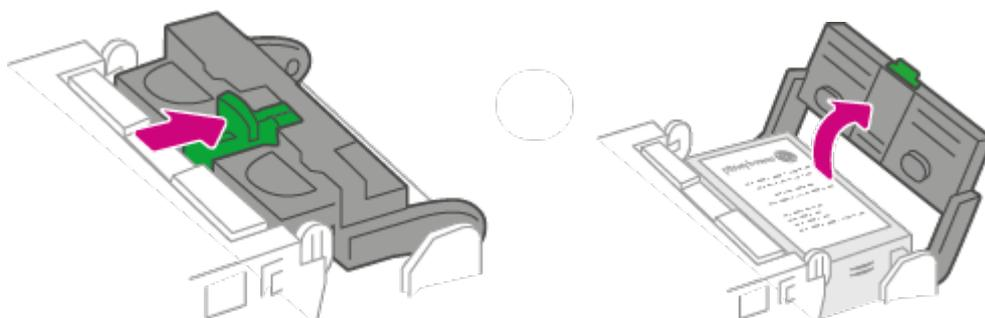

6. Remove the ink cartridge.

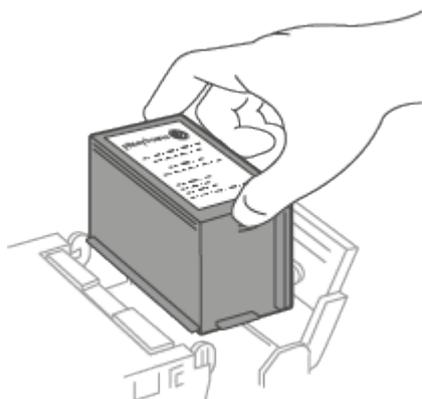

7. Squeeze the two gray tabs on either side of the printhead.

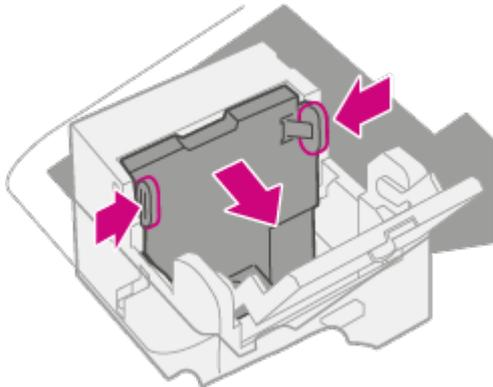

8. While squeezing, lift and tilt the printhead to the right. The printhead should come up out of the device.

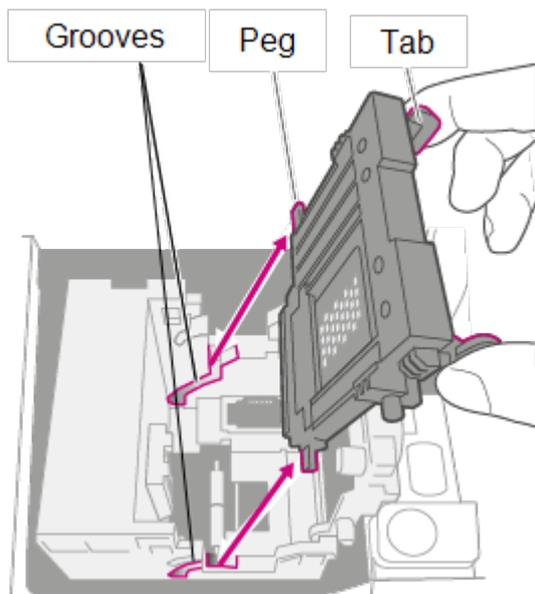

9. Unwrap the new printhead and remove the protective strip.

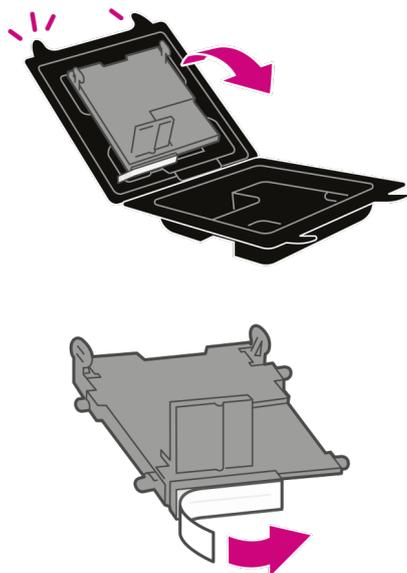

10. Squeeze the tabs and slide the printhead pegs into the lower set of grooves.

Warning: If you do not seat the printhead correctly it can damage the device.

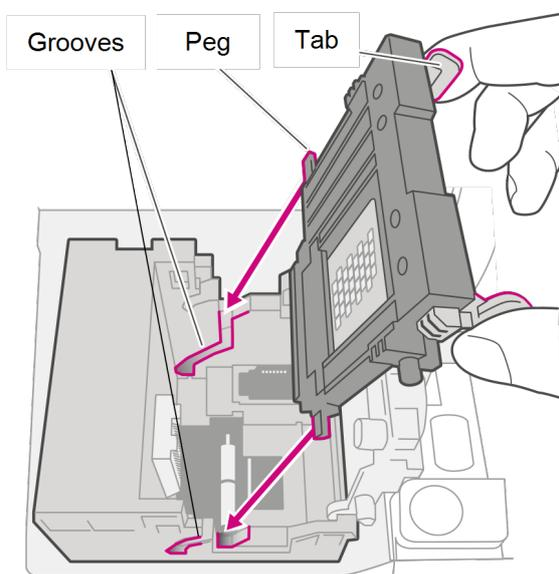

11. Keep squeezing the tabs and push the printhead flush against the wall. Tabs will snap outward when placed correctly.

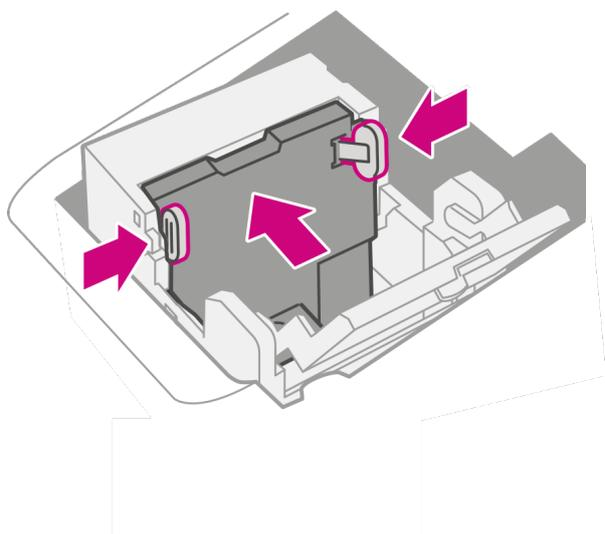

12. Install the ink cartridge and close the guard.

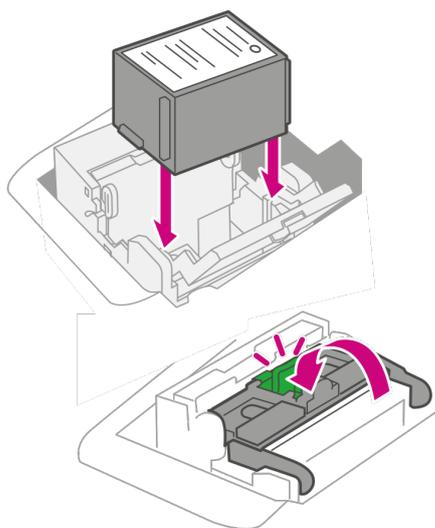

13. Close the cover. The ink cartridge moves back to the original position.

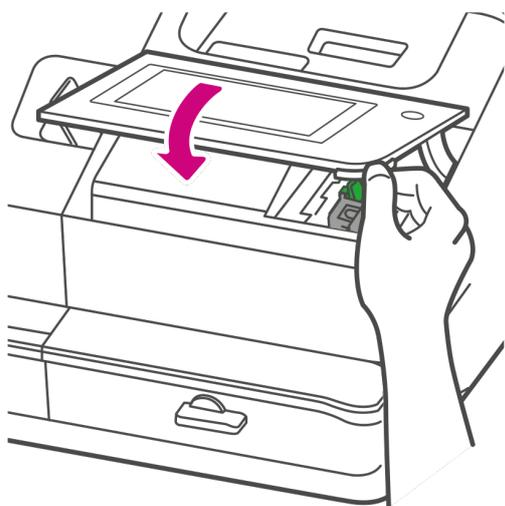

14. Tap **Done**.
15. Print a print test pattern to be sure that your printhead is working properly.

Installing a scale

Install a scale if you did not install one when you installed your device. Your device contains step-by-step installation instructions for compatible scales.

1. Tap **Settings**.



2. Scroll to the Advanced Device Options section at the bottom of the Settings screen, then tap **Scale Installation Guides**.

3. To view all the available scales, swipe to the left on the screen.

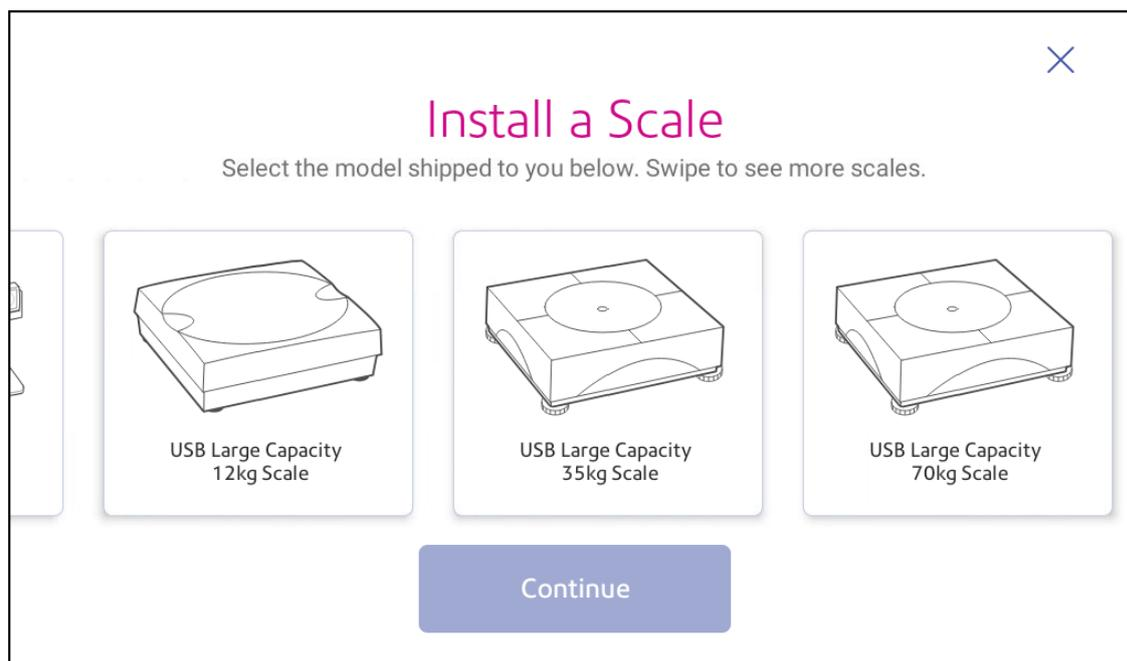

4. Tap to select the appropriate scale, then tap **Continue**.
5. Follow the instructions on the screen. To advance to the next step, swipe the screen to the left.

Installing an external scale

Use an external scale if you send large packages or parcels. External scales have a larger weight capacity for heavier items.

1. If you are using the scale that is located on top of the device, remove the scale by lifting it off.



2. Fix the blanking plate on the device where the scale was located.



3. Tap **Settings**.



4. Scroll down and tap **Scale Installation Guides**.

5. Swipe to the left and select the scale you are installing.

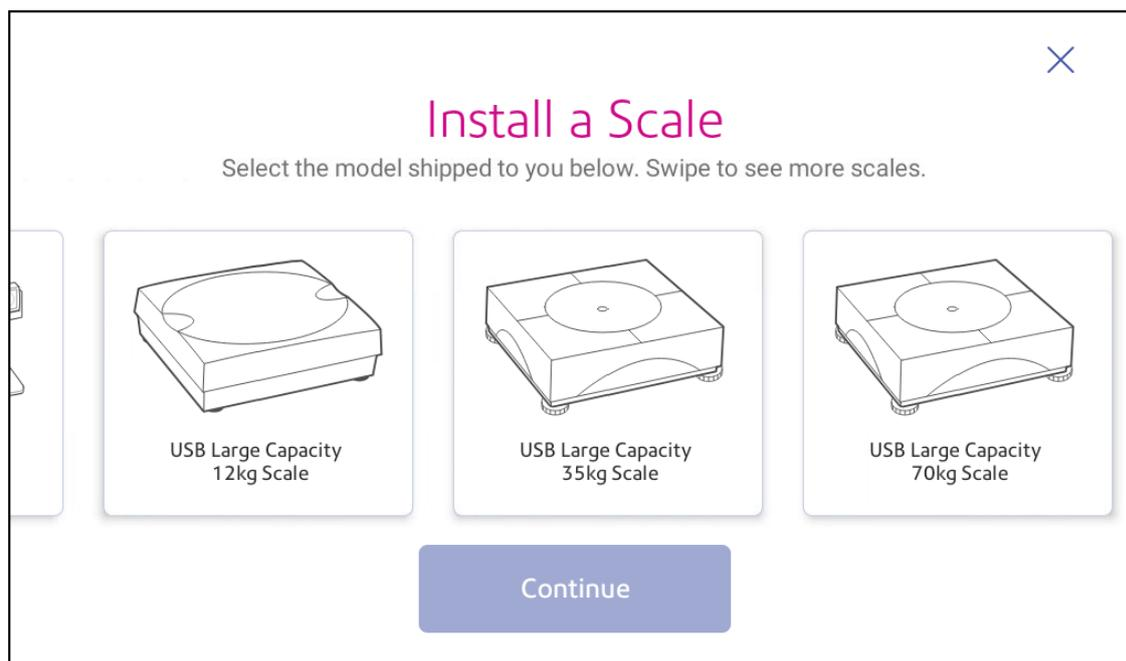

6. Tap **Continue**.
7. Following the on-screen instructions. Swipe to the left and unbox the scale.
8. Position and level the scale. The scale has a level bubble under its lid. Ensure the bubble is within the circle of the level bubble by adjusting the round feet of the scale.
9. Connect the large end of the USB cable into the device. Connect the other end into the scale.
10. Tap **Continue**.
11. Tap **Verify**.
12. Tap **Got It**.
13. Tap **Envelope Printing**.
14. Tap **Weight**, then tap **Scale**.
15. Place the mail on the scale.
16. Tap **Apply**.

2 - Connectivity

In this section

Setting up a wired network connection.....	27
Setting up a wireless (Wi-Fi) network connection.....	29
Connecting to a hidden Wi-Fi network.....	30
Forgetting a Wi-Fi network.....	32
Checking your network connection.....	34
Finding the MAC address for wired and wireless networks.....	34
Setting up a Proxy server.....	38

Setting up a wired network connection

Use a network cable to connect your SendPro C Lite, SendPro C to the Pitney Bowes Data Center.

Step 1: Plug in your network cable

Plug one end of your network cable to your device and the other end to an internet jack on the wall or a router.

Step 2: Choose the connection type

Select one of the two connection types supported for this device:

- *DHCP*
- *Static IP*

DHCP is the most common connection type. Choose DHCP if you are unsure which connection protocol to use or contact your IT department for advice.

DHCP

1. Tap **Settings**.

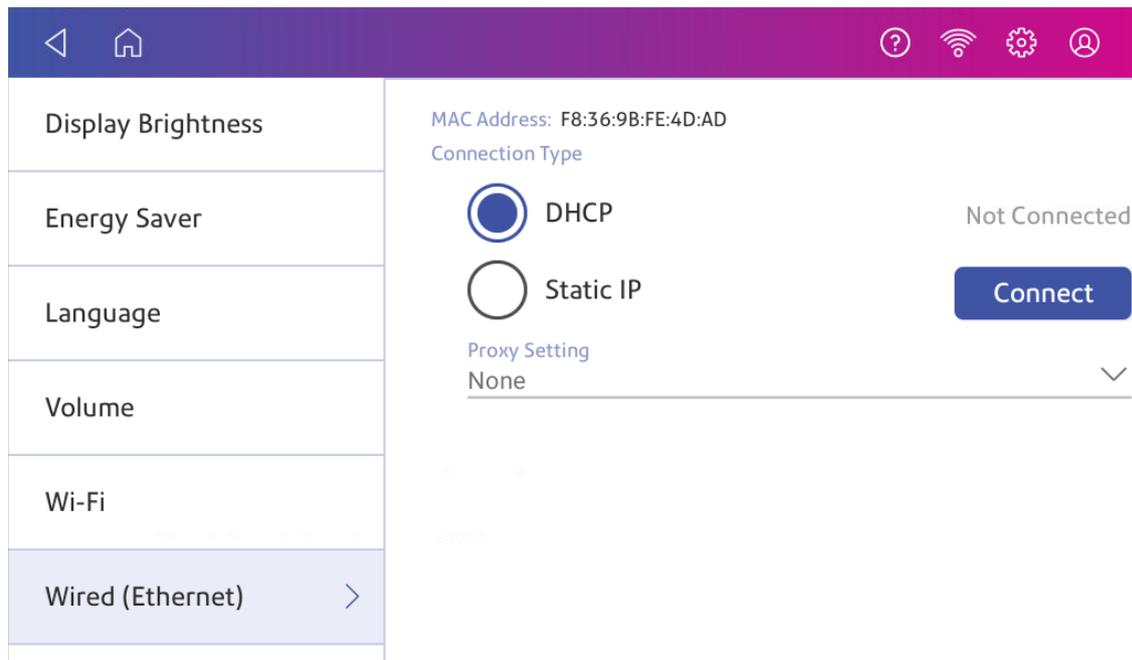

2. Tap **Wired**.

3. Select **DHCP**.4. Tap **Connect**.

5. If it does not connect, unplug the power cord.

6. Wait 30 seconds. The screen should turn off after 10 seconds.

7. Plug the power cord back in directly into a wall outlet.

8. Quickly tap and release the power button to turn the device back on.

9. Tap **Settings**.10. Tap **Wired (Ethernet)**.11. Tap **DHCP**.12. Tap **Connect**.

Static IP

1. Tap **Settings**.2. Tap **Wired**.

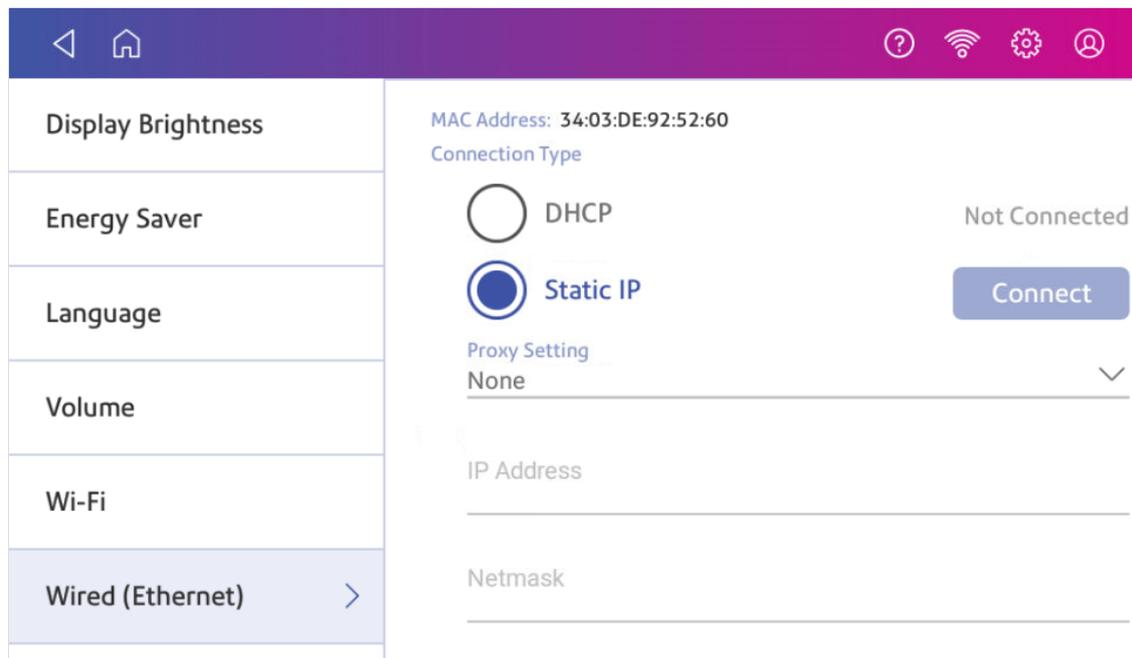
3. Select **Static**.

4. Contact your IT department to obtain the settings you will need to enter for your device. The values needed are:
 - **IP Address**
 - **Netmask**
 - **Gateway**
 - **DNS Address.**
5. Enter the settings you obtained in step 4 for the **IP Address**, **Netmask**, **Gateway**, and **DNS Address** in the corresponding fields.
6. Tap **Connect**.
7. If SendPro C Lite, SendPro C fails to connect, remove the network cable from the back of the device.
8. Tap **Connect**. Wait for the attempted connection to fail.
9. Plug the network cable back in.
10. Delete the values in the **IP Address**, **Netmask**, **Gateway**, and **DNS Address** fields.
11. Enter the **IP Address**, **Netmask**, **Gateway**, and **DNS Address** that you obtained in step 4.
12. Tap **Connect**.

Setting up a wireless (Wi-Fi) network connection

You can connect your SendPro C Lite, SendPro C with a wireless network connection.

1. Tap **Settings**.



2. Tap **Wi-Fi** in the Device & Network section.
3. Choose your Wi-Fi network from the list. Tap **Add Network** if your Wi-Fi network does not appear.
4. Enter your Wi-Fi password.
Tip: Use the show password option to make sure that you enter your password correctly.
5. Tap **Advanced Options** if your network requires advanced network settings such as a Static IP address:
 - To set up a Static IP address:
 - a. Select the **IP Setting** menu and choose **Static**.
 - b. Tap on the line and enter the value provided by your IT department.
 - c. Tap the > in the green circle.

Connecting to a hidden Wi-Fi network

Add a network when you want to connect using Wi-Fi and your network is not present in the Wi-Fi list.

1. Tap **Settings**.



2. Tap **Wi-Fi** in the Device & Network section to see a list of available networks.

3. Tap **Add Network** at the top of the Wi-Fi screen.

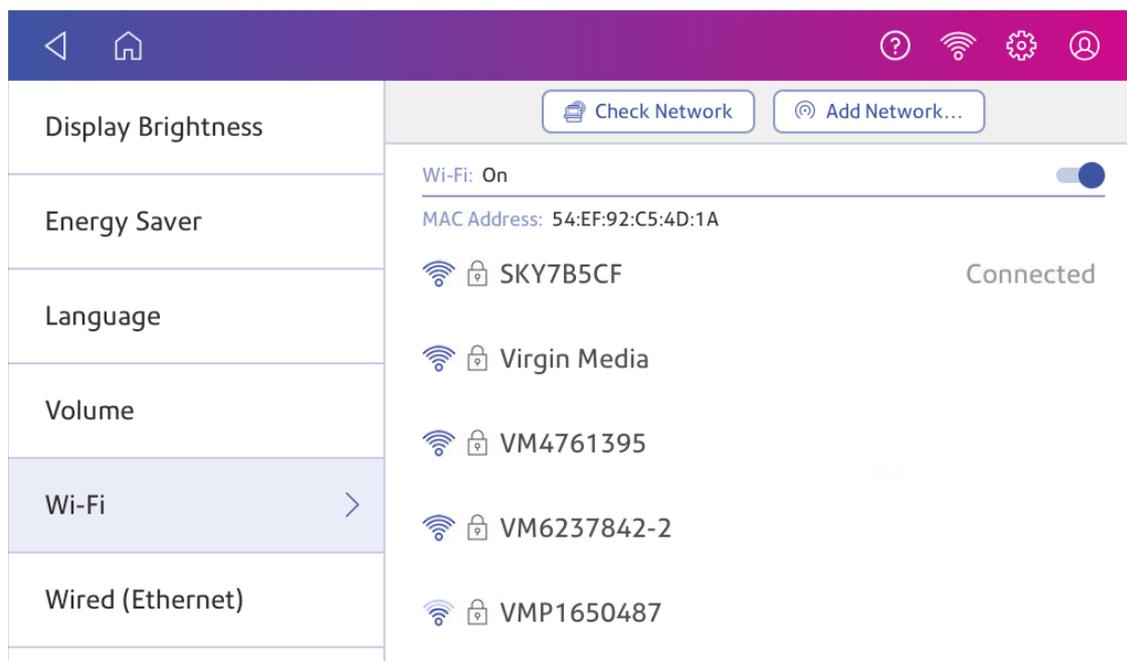

4. For each of the following steps, please consult with your IT department to obtain the necessary information.
 - a. Tap the down arrow in the Security field and select the security method.

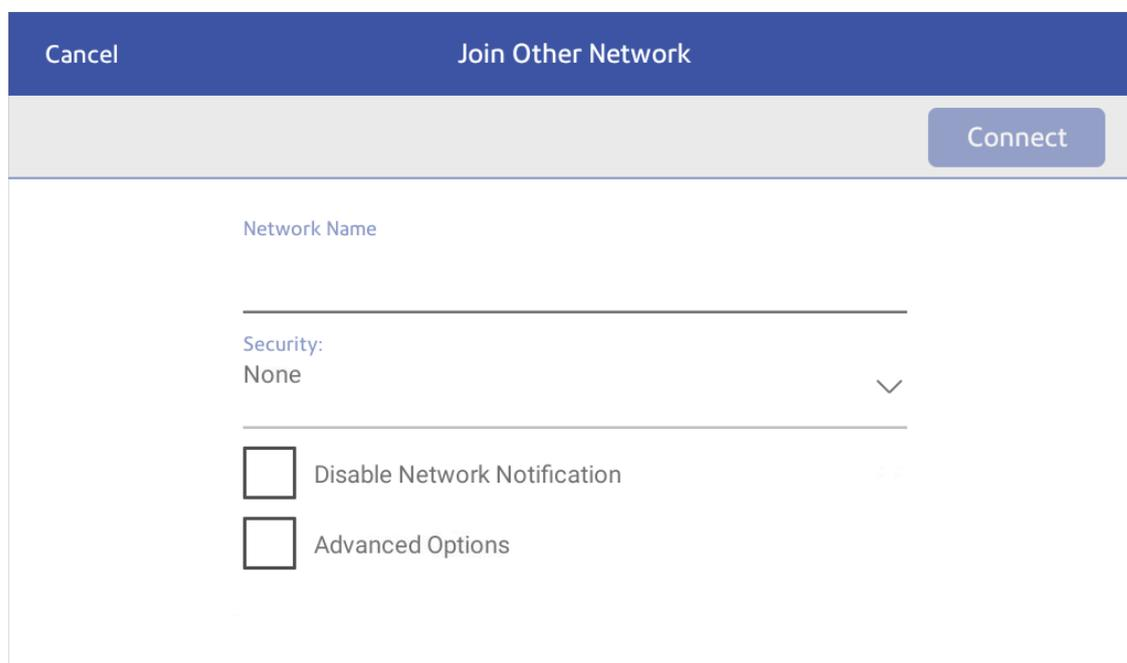

- b. Tap **Advanced Options** to enter a static IP or set up a proxy.
5. Tap **Connect** when done.

Forgetting a Wi-Fi network

Forget a Wi-Fi network if:

- You do not want your device to automatically connect to that network or
- You need to resolve a wireless network issue.

1. Tap **Settings**.



2. Tap **Wi-Fi** in the Device & Network section.

3. Tap the network you want to forget. Note that you can only forget a network to which you have previously connected.

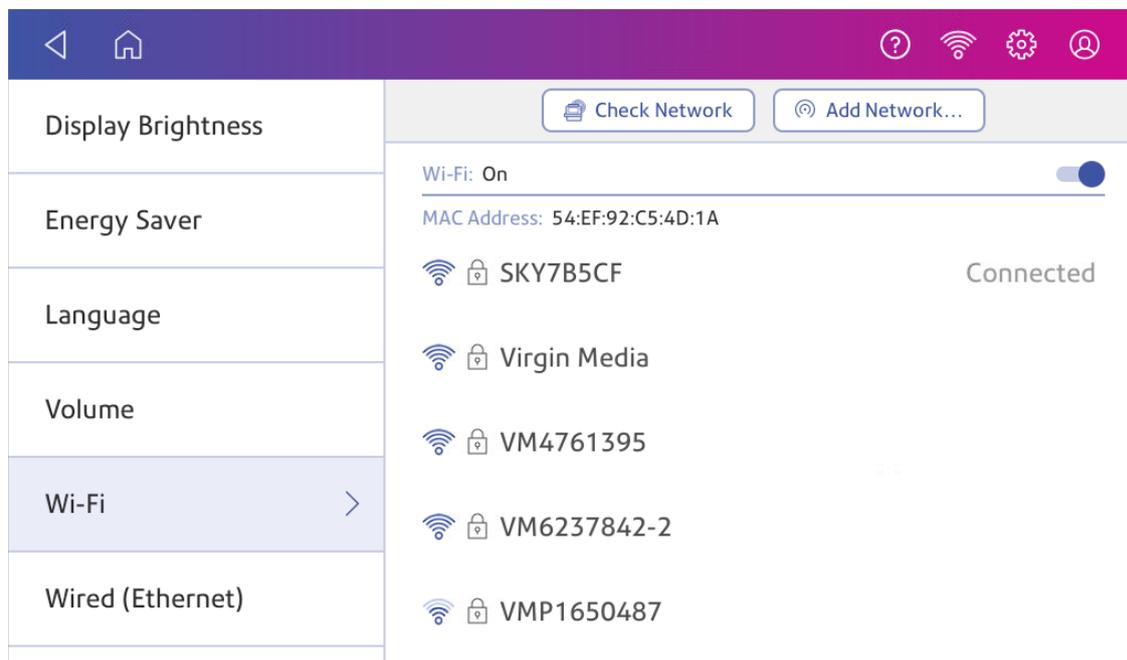

The network details appear.

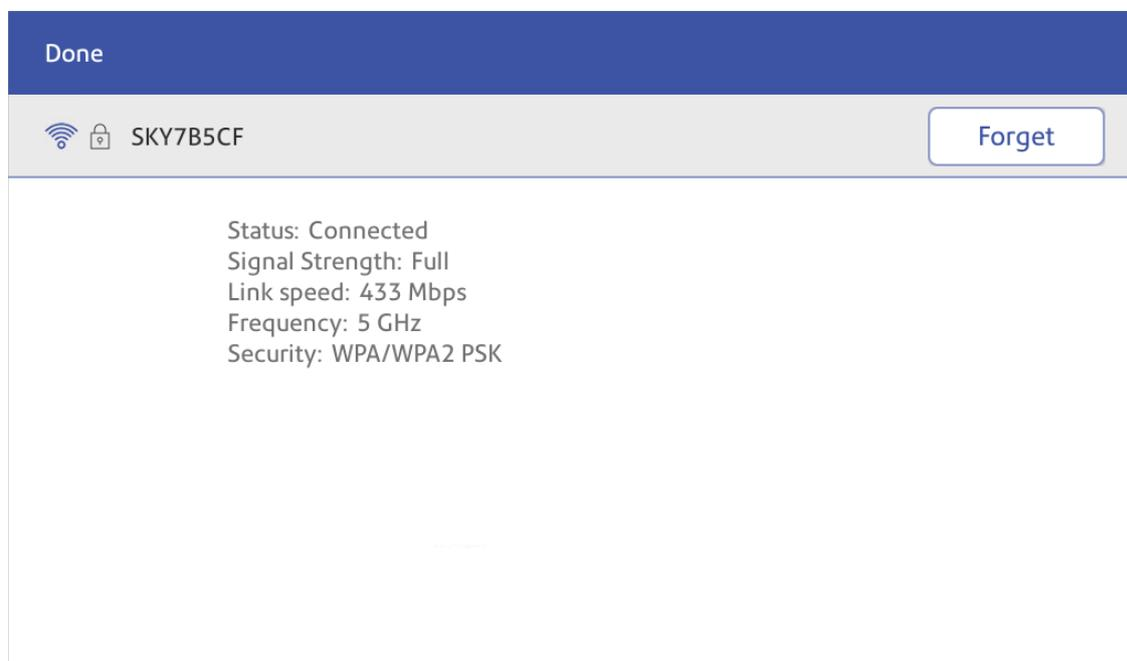

4. Tap **Forget** to forget the network connection.

Checking your network connection

Use the Network Connection app to check that you have the necessary internet services to connect to the internet. The app helps diagnose network connection issues.

Your IT department may be blocking certain services. Only they will know if the necessary services are available on your network.

1. To open and run the network checking app:
 - Tap **SendPro Apps** on the Home screen, then tap **Network Connection**.
2. The device then provides you with the results of the network check.
3. Tap **Close** twice to return to the Home screen.

If you are unable to connect to the internet, ask your IT department or internet provider to check the internet settings before you contact Pitney Bowes.

Finding the MAC address for wired and wireless networks

The MAC address is the network identifier for the device. IT uses it to allow the device onto the network.

Your device contains two MAC addresses: One for wireless connections and one for wired connections.

Locating the MAC address for wireless connections

1. Tap **Settings**.



2. Tap **Wi-Fi**.

- The MAC address appears above the list of wireless networks.

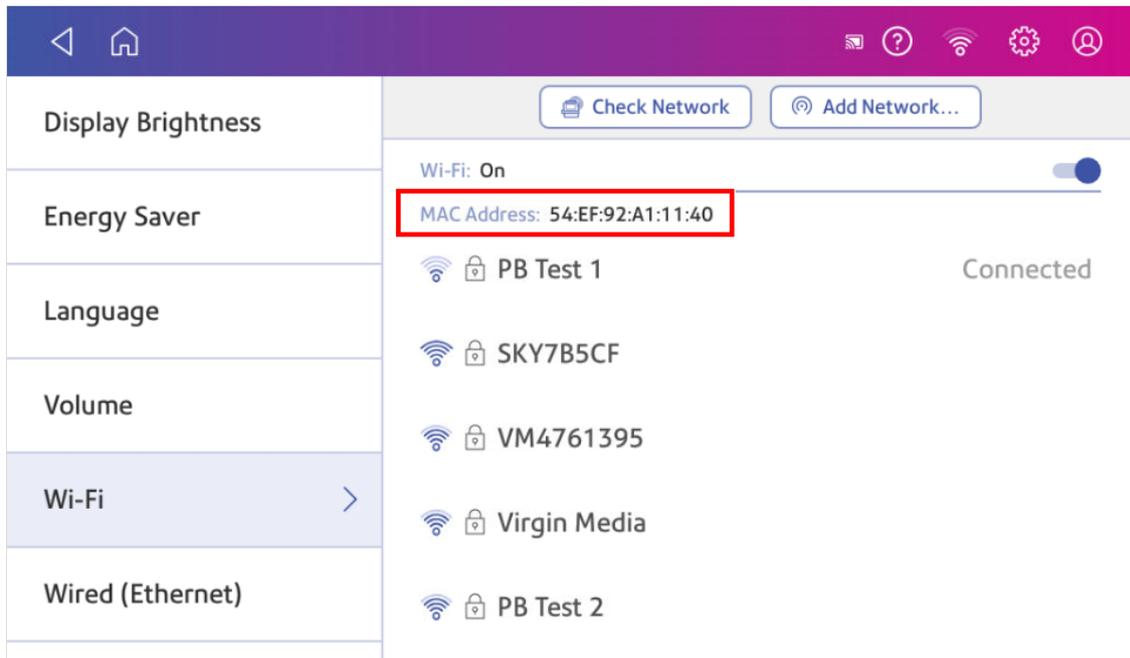

Locating the MAC address for wired connections

- Tap **Settings**.



2. Tap **Wired (Ethernet)**. The MAC address is present at the top of the screen.

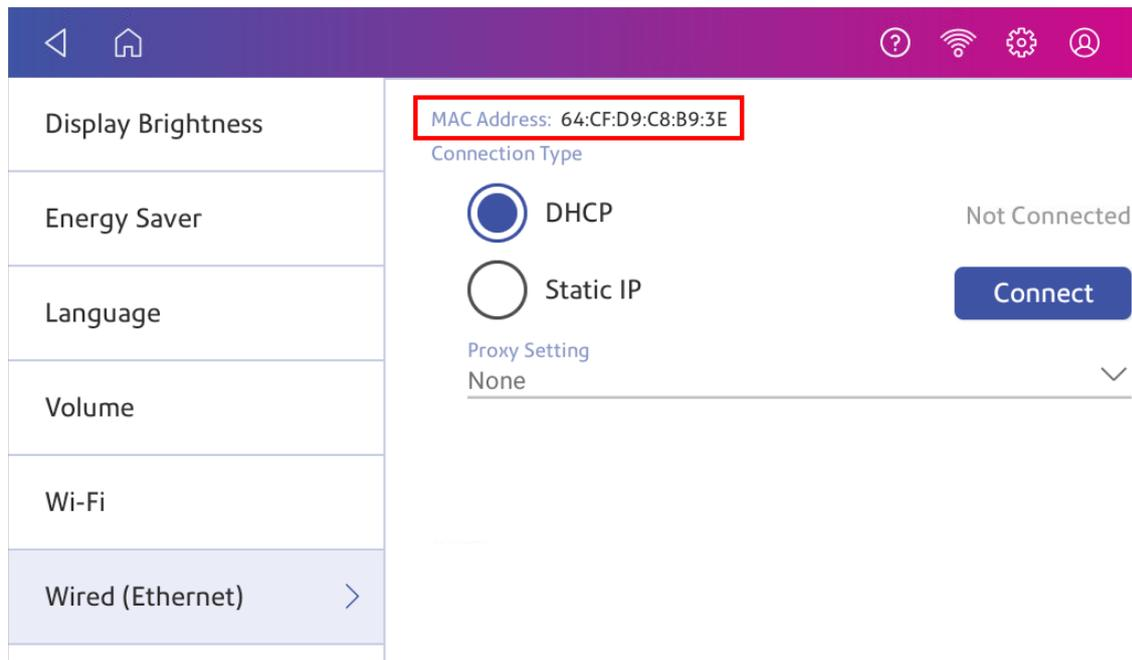

3. Tap **Check Network**. The Checking Network Connection screen appears.

4. Tap **View Details** in the Connected to wired network box when the test finishes.

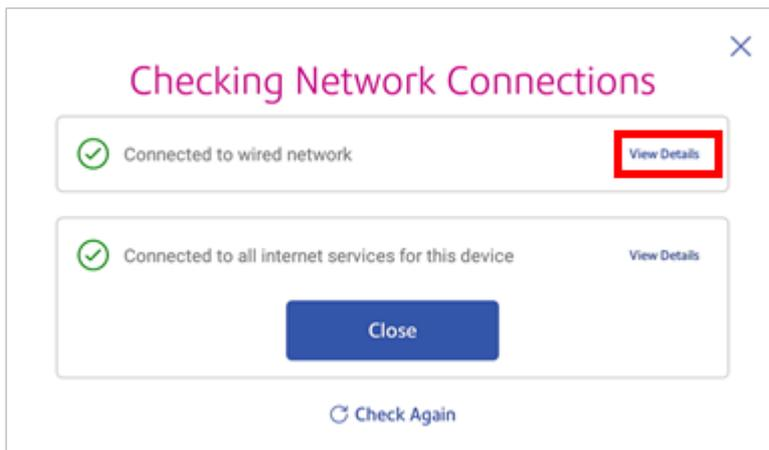

The MAC address appears:

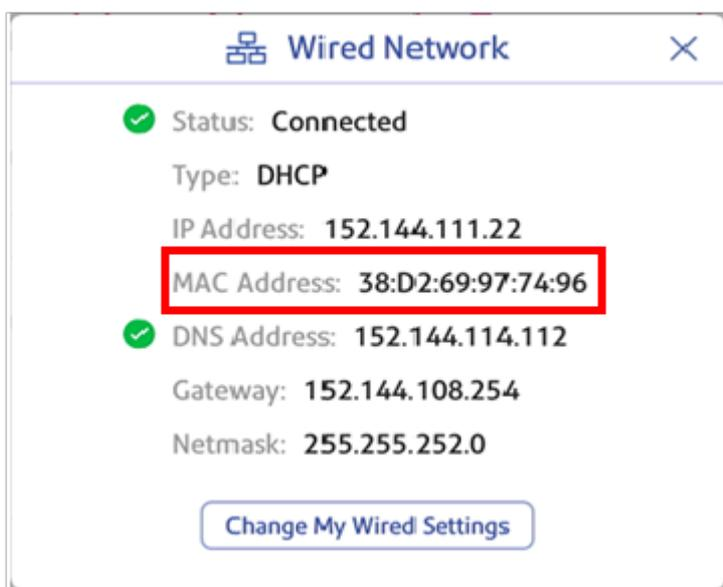

5. Tap **X** to close this window.
6. Tap **Close**, then the **back arrow** to return to the Home screen.

If the MAC address does not appear, try these steps:

1. Tap **Settings**.



2. Scroll down to the Advanced Device Options section and tap **About This Device**.

3. Scroll down to the Base Network Info section to locate the MAC Address.

Cancel	System Info	Upload Report
Base Network Info DHCP Disabled DNS0 192.168.0.1 DNS1 null DNS2 null DNS3 null Gateway 192.168.10.244 IP 0.0.0.0 IPV6 null IPV6LINK null LanState false MacAddress 64:CF:D9:C8:B9:3E Name eth0 Netmask 0.0.0.0		Rates Rate Manager version 11.05 Weight units METRIC Module count Total:7 Active rating:7 Module info CCF: HZAU000.H.01 HZAU001.C01 ID: 49 HZAU002.C01 ID: 50 HZAU003.C01 ID: 51 HZAU004.D01 ID: 52
Wifi Network Info IP 192.168.0.80 Gateway 192.168.0.1 Netmask 255.255.255.0		

4. Tap **Cancel** to return to the Home screen.

Setting up a Proxy server

A Proxy server is a computer that acts as a gateway between your local network, your device, and the internet. Proxy servers provide increased performance and security.

If your network requires a proxy server, you must contact your IT department or service provider to obtain the proxy server information to set up a proxy server.

Choose the connection type

Choose how you connect your device to set up a Proxy server:

- [Setting up a Proxy server using a Wi-Fi network connection](#)
- [Setting up a Proxy server using a wired network connection](#)

Setting up a Proxy server using a Wi-Fi network connection

1. Tap **Settings**.



2. Tap **Wi-Fi** in the Device & Network section.
3. Select the network from the list.
4. Tap on the **Advanced Options** checkbox to select it.
5. Scroll down and tap the arrow next to Proxy, then select **Manual**.

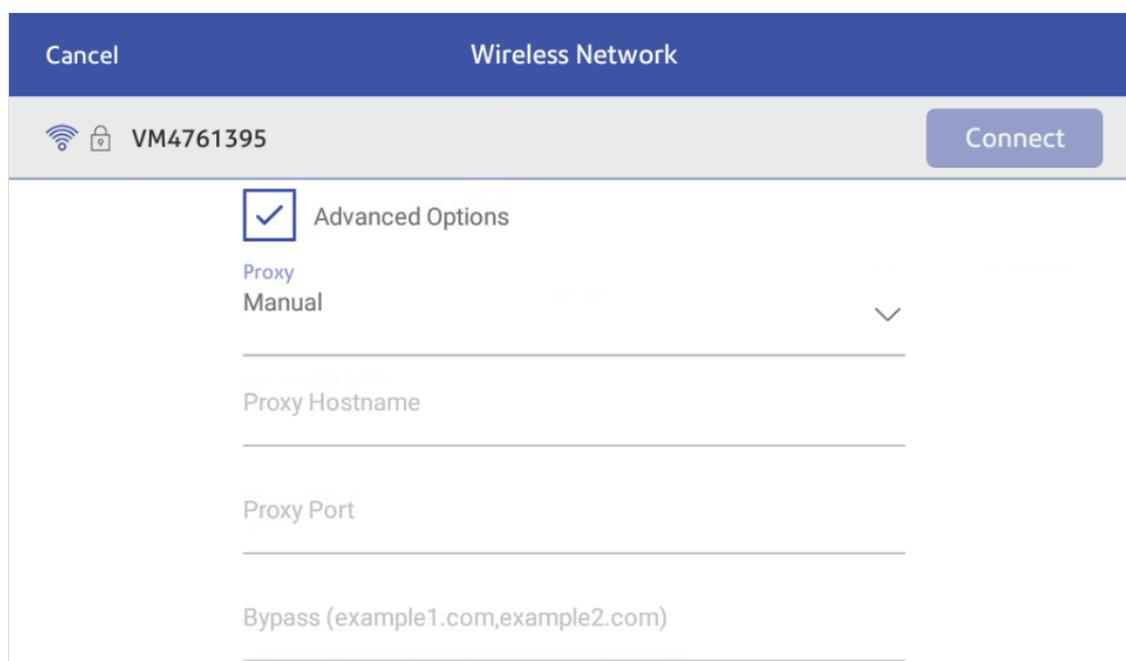

6. Enter the IP address, HTTP or HTTPS proxy address of your proxy server in the **Proxy Hostname** field.
7. Enter the port number for the proxy server in the **Proxy Port** field.
8. (Optional) Enter any specific URLs or URL patterns (such as internal addresses) that you wish to bypass the proxy in the **Bypass** field.
9. If your Proxy Server requires authentication, select the **Need Authentication** check box. Additional fields appear.
 - a. Enter the Proxy username in the **Proxy Username** field. This may be case sensitive for some proxy servers.
 - b. Enter the Proxy password in the **Proxy Password** field. This is case sensitive for proxy servers.

Setting up a Proxy server using a wired network connection

1. Tap **Settings**.



2. Tap **Wired (Ethernet)** in the Device & Network section.
3. Select either **DHCP** or **Static IP**.
4. If you select DHCP, tap on the drop-down arrow next to Proxy Setting and select **Manual**.

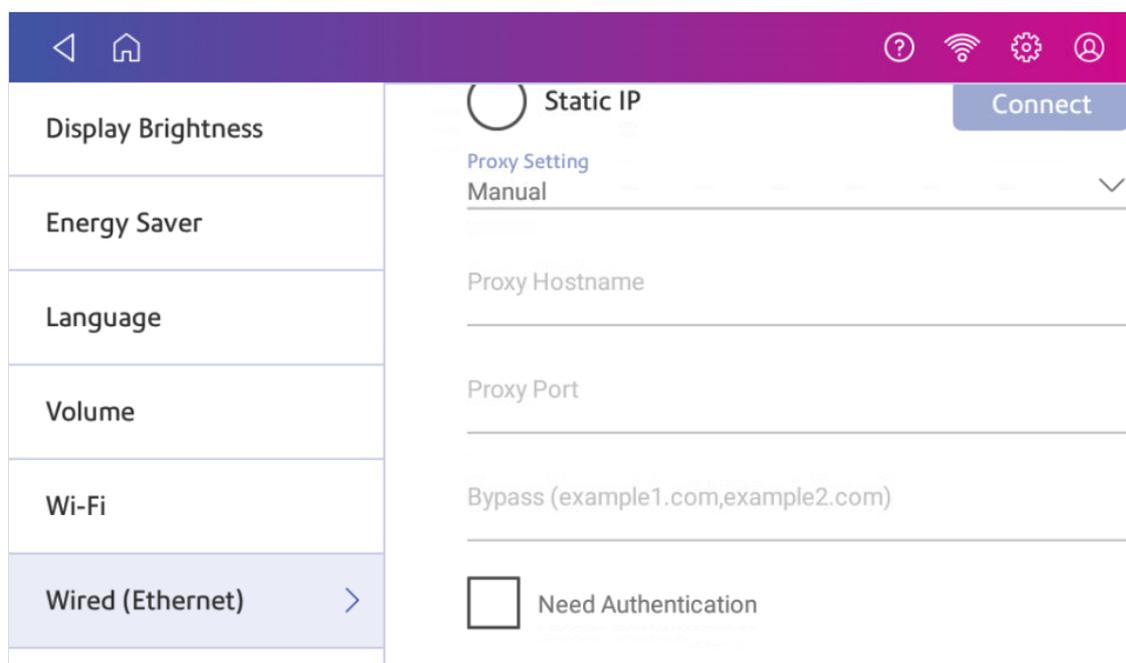

5. Enter the IP address, HTTP or HTTPS proxy address of your proxy server in the **Proxy Hostname** field.
6. Enter the port number for the proxy server in the **Proxy Port** field.
7. (Optional) Enter any specific URLs or URL patterns (such as internal addresses) that you wish to bypass the proxy in the **Bypass** field.
8. If your Proxy Server requires authentication, select the **Need Authentication** check box. Additional fields appear.
 - a. Enter the Proxy username in the **Proxy Username** field. This may be case sensitive for some proxy servers.
 - b. Enter the Proxy password in the **Proxy Password** field. This is case sensitive for proxy servers.

3 - Scales and Weighing

In this section

Using the scale when printing postage.....	42
Entering the weight manually when printing postage.....	42
Zeroing the scale.....	43

Using the scale when printing postage

Use the scale to weigh your mail and calculate the correct postage for you.

1. Tap **Envelope Printing** on the Home screen.
2. Tap **Weight**.

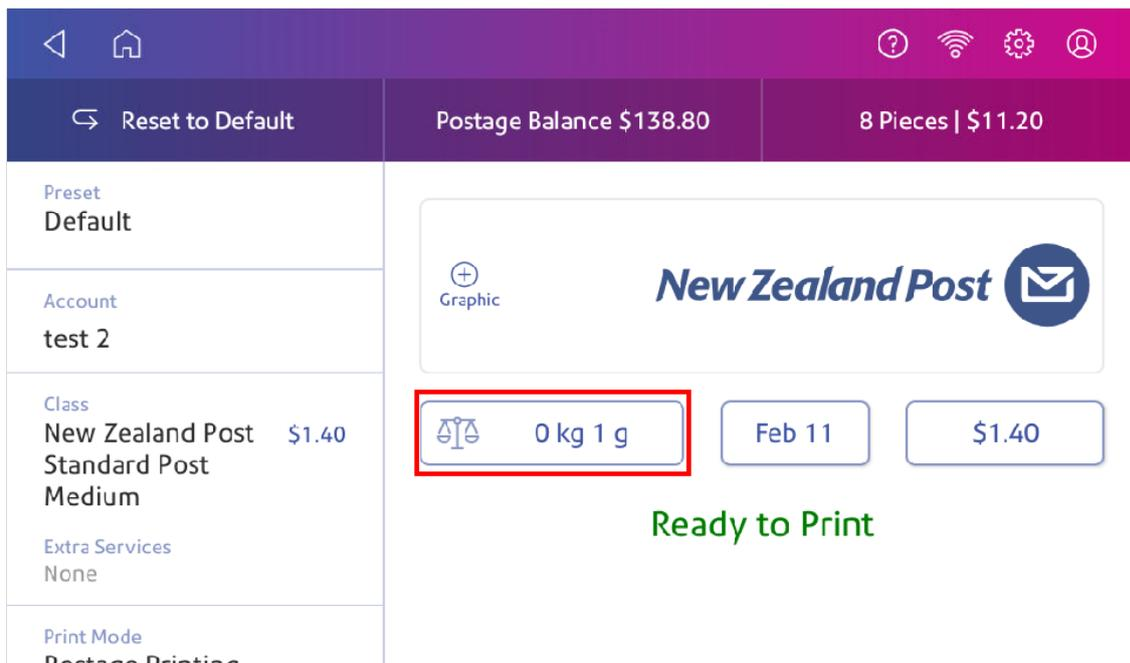

3. Tap **Scale**.
4. Place the envelope on the scale. You must do this before the next step or else the **Apply** button remains inactive.
5. Tap **Apply**.
6. Tap **Class**.
7. Select **Start Over** to show the class options.
8. Tap the class you want.
9. Select special services, if required.
10. Tap **Apply**.
11. Insert the envelope into the device. The device prints the postage.

Entering the weight manually when printing postage

Enter the weight of a mailpiece when you know its weight and are not using the scale.

1. Tap **Envelope Printing** on the Home screen.
2. Tap **Weight**.

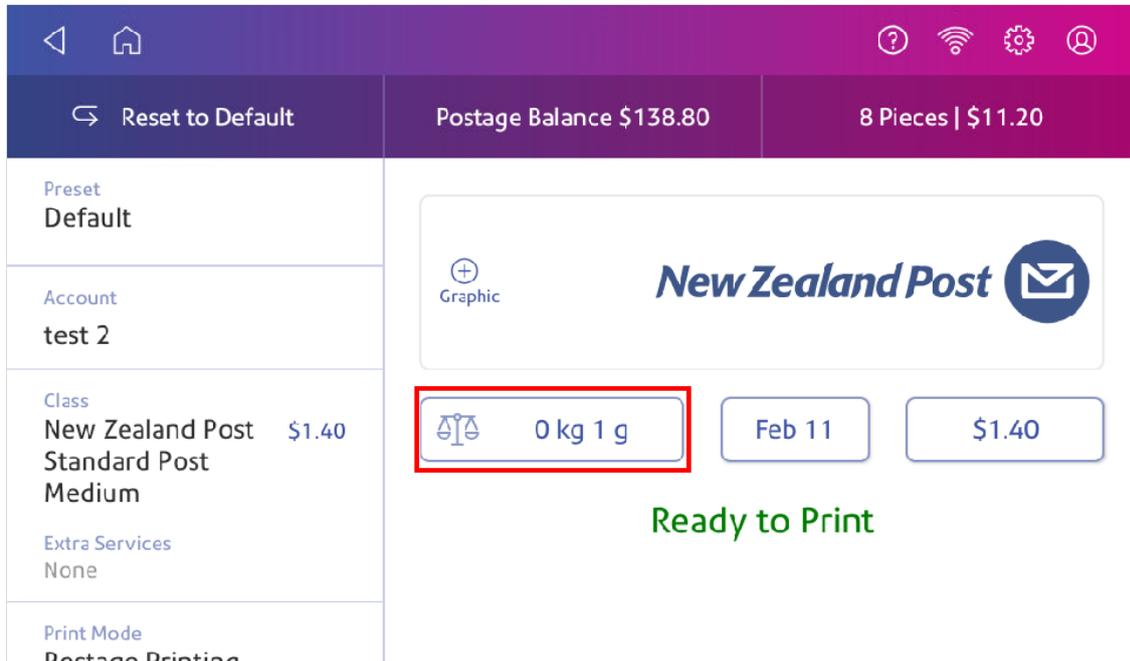

3. Tap **Manual**.
4. Enter the **kilograms** and **grams**.
5. Tap **Apply**.
6. Tap **Class**.
7. Tap **Start Over** to see all the class options.
8. Select the class and any special services required.
9. Tap **Apply**.
10. Insert the envelope into the device. The device prints the postage.

Zeroing the scale

Zero the scale to set the weight to zero.

Make sure there is nothing on the scale when you zero it.

1. Tap **Envelope Printing** on the Home screen.
2. Tap **Weight**.

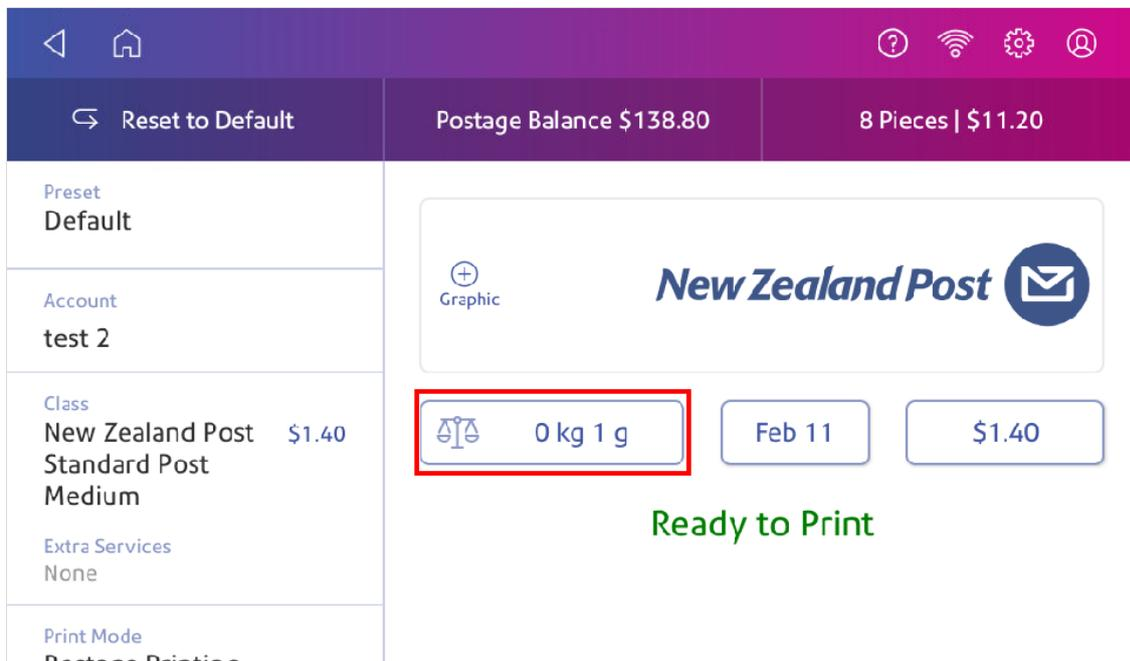

3. Tap **Scale** on the weighing method screen.
4. Tap **Zero Scale**.
5. Tap **Cancel** to return to the Envelope Printing screen.

4 - Accounting

In this section

What is Accounting.....	46
Creating your first Envelope Printing account.....	47
Selecting an account.....	48
Editing an account.....	48
Making an account inactive.....	49
Deleting a Envelope Printing account.....	49

What is Accounting

You can use the accounting feature to track the postage that departments or individuals within your organization use.

The accounting feature helps you to understand how your business spends its postage and identify cost-saving opportunities. You can charge postage back to departments or clients and report on postage expenditures.

When you use Envelope Printing accounts to track your postage usage, use sub accounts and sub sub accounts to analyze your usage within an account.

How you create accounts depends on your needs. You can create accounts in single or multiple levels. For example, you can divide a top level department (account) into two additional sub sections (sub accounts and sub sub accounts).

The Envelope Printing accounting structure can have up to a three level hierarchy:

- account (top level of the hierarchy)
- sub account (next possible level of the hierarchy)
- sub sub account (last possible level of the hierarchy)

Important: Only the lowest level of the account hierarchy is chargeable. This means that the lowest level of the account has the transactions applied to them.

- **Account with no sub accounts** - When you create an account with no sub accounts, you charge postage to that account. This is because the account does not have sub or sub sub accounts.
- **Account with sub account or sub sub account** - When you create a sub account or sub sub account, you charge postage to the lowest level (the sub account or sub sub account).

Account hierarchy examples

Top level account

- Engineering

Account with sub accounts

- Engineering; Sub account - Software;
- Engineering; Sub account - Hardware;

Account with sub sub accounts

- Engineering; Sub account - Software; Sub sub account - Graphics and Layout; Sub sub account - Design

- Engineering; Sub account - Hardware; Sub sub account - Quality Approval; Sub sub account - Testing

Creating your first Envelope Printing account

Create your first account to record Envelope Printing usage by department.

Accounting is a feature that is optional and needs enabling if you want to use it. Contact your Pitney Bowes Sales Representative for information about options and pricing.

An account is created automatically for you during installation. The account is called General.

You can edit the name if you want to, providing you have not printed any post against it.

You can create more accounts if you would like to.

1. Tap **Envelope Printing** on the Home screen.
2. Tap **Account**.
3. Tap **Manage Accounts**.
4. Tap **Create new account** twice.
5. Enter the account name in the Account name field. Account names can be up to 75 characters long.

If the keyboard does not pop up, tap on the line in the gray box.

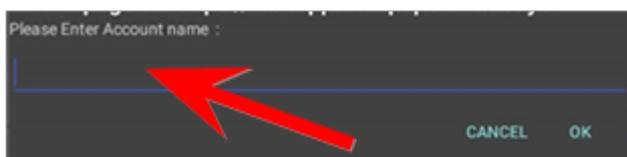

6. Enter a unique code in the Code field to identify each account. Codes can be alphanumeric.
7. You can use the optional fields, such as:
 - **Description** - Enter a description of the account up to 150 characters.
 - **Password** - Tap **Password** to add a password for an account.
 - Passwords are case sensitive, can be alphanumeric, and must be four characters in length. You must enter this password to edit or feed mail against the account once enabled.
8. Ensure you set the status to active.
9. Tap anywhere on the screen, but outside of the fields when complete.

10. Tap **OK** to save. The name of the new account appears.
 - Tap **Create New Account** to create another account.
 - Tap **Add a Sub Account to this account** to add a sub account to the account you just created.
 - Tap **Continue** if you do not need to create any more accounts.
11. Press the back arrow to return to the account list.

Selecting an account

When accounting is enabled on your device, you must select an account before you can print postage.

1. Tap **Envelope Printing** on the Home screen.
2. Tap **Account**.
3. Tap the account you wish to use for your mail.

Tip: You can then create a preset which you use to quickly select the same settings in the future.

Editing an account

Edit an account when you want to change the account name, code, description, status or password.

Important: Once you charge postage to an account, you cannot change the account name or code.

1. Tap **Envelope Printing** on the Home screen.
2. Tap **Account**.
3. Tap **Preferences**.



4. Tap **Manage Accounts**.
5. Tap **Edit account**.
6. Tap the account you want to edit.
7. Select **OK**.
8. Make your changes, such as edit the account name, code, description, status or password.
9. When finished, tap anywhere on the screen outside of the fields.
10. Tap **OK** to return to the Accounts screen.
11. Tap the back arrow to return to the list of accounts.
12. Tap **Cancel** to return to the Envelope Printing screen.

Making an account inactive

Setting the account status to inactive prevents anyone from charging postage against it.

1. Tap **Envelope Printing** on the Home screen.
2. Tap **Account**.
3. Tap **Preferences**.



4. Tap **Manage Accounts**.
5. Tap **Edit account**.
6. Tap the account you want to make inactive.
7. Select **OK**.
8. Tap **Inactive**.
9. Tap **OK** to return to the Accounts screen.
10. Tap the back arrow to return to the list of accounts.
11. Tap **Cancel** to return to the Envelope Printing app.

Deleting a Envelope Printing account

You can delete an account, sub account, or sub sub account through the Envelope Printing app.

If you apply postage to an account, you cannot delete the account. You can only make the account inactive.

1. Tap **Envelope Printing** on the Home screen.
2. Tap **Account**.
3. Tap **Preferences**.



4. Tap **Manage Accounts**.
5. Tap **Delete account**. The list of available accounts appears.
6. Tap the account you want to delete.
7. Tap **OK**.
8. Tap **Yes, delete account** to confirm.
9. Tap **OK**.

10. Tap the back arrow to return to the list of accounts.
11. Tap **Cancel** to return to the Envelope Printing app.

5 - Postage Funding

In this section

Checking the available funds for printing postage.....	52
Refilling postage funds for printing postage.....	53
Changing the default refill amount for printing postage.....	54
Setting the low funds warning for printing postage.....	55
Getting a New Zealand Post refund for damaged or incorrectly printed mail in Envelope Printing	56
Viewing the refill history for printing postage.....	56
Printing a funds report	56

Checking the available funds for printing postage

Viewing the amount available in your device

1. Tap **Envelope Printing** on the Home screen.
2. The **Postage Balance** shows the available funds in your device.

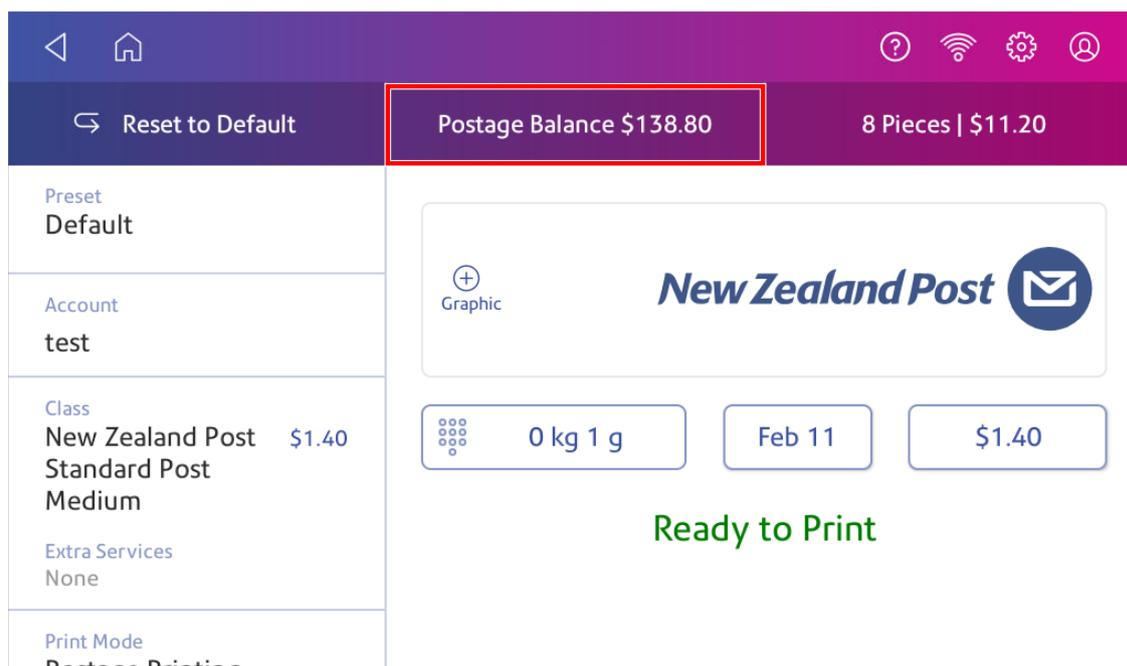

Viewing the amount available in your postage account at Pitney Bowes

1. Tap **Envelope Printing** on the Home screen.
2. Tap **Postage Balance**.

3. Tap **Refill Settings**.

Refilling postage funds for printing postage

Refill your postage funds for printing postage as soon as you receive a message that your funds are low.

Before you begin

Check that your device is connecting to the internet.

- For wired network connections, you will see the following connection image in the toolbar:



- If you have a wireless connection, you will see the following connection image in the toolbar:



To refill postage:

1. Tap **Envelope Printing** on the Home screen.
2. Tap **Postage Balance**.
3. Tap **Refill Postage**.
4. Enter the postage refill amount.
5. Tap **back** to change the amount shown.



6. Tap **Refill Mail Postage**.
7. Tap **View Receipt** to view or print a receipt.
8. Tap **Done**. Your updated postage balance appears on the Envelope Printing app.

Changing the default refill amount for printing postage

Change the default refill amount to store an amount you want to refill your device with.

You can set the default refill amount during installation or change it at later time.

There are two ways to change the default refill amount:

From the Home Screen:

1. Tap **Settings**.



2. Scroll down to the Envelope Printer Settings section.
3. Tap **Postage Refills**.
4. Tap the box under **Default refill amount**.
5. Tap the back key to remove the existing amount. You may need to tap the key multiple times to clear the amount.
6. Enter the new amount.
7. Tap **Apply**.
8. Tap the back arrow to return to the Home screen.

From Envelope Printing:

1. Tap **Envelope Printing** from the Home screen.
2. Tap **Postage Balance**.
3. Tap **Refill Settings**.
4. Tap the box under **Default refill amount**.
5. Tap the back key to remove the existing amount. You may need to tap the key multiple times to clear the amount.
6. Enter the new amount.
7. Tap **Apply**.
8. Tap the back arrow to return to the Envelope Printing app.

Setting the low funds warning for printing postage

Set the low funds warning to warn you when your available funds for printing postage reaches a certain amount. Use this warning as a reminder to add more postage to your device.

1. Tap **Envelope Printing** on the Home screen.
2. Tap **Postage Balance**.
3. Tap **Refill Settings**.
4. Tap **Low postage threshold**.
5. Tap **back** on the keypad to remove the existing amount.
6. Enter the new amount.
7. Tap **Apply**.
8. Tap **back** to return to the Envelope Printing app.

Getting a New Zealand Post refund for damaged or incorrectly printed mail in Envelope Printing

Once you print an impression, your device deducts the postage amount from the postage funds. This happens even if the printing is illegible. Therefore, it is important you select the correct value before printing postage.

For up-to-date refund guidelines, refer to the New Zealand Post website.

To request a refund please contact your device supplier for further information.

Viewing the refill history for printing postage

View a report showing all your postage refill history.

1. Tap **SendPro Apps** on the Home screen
2. Tap **Print Refill Receipt**.
3. Tap **Refill History**.
4. Tap on a postage refill to open a Refill Receipt.

Important: At this time, you can only view the report.

Printing a funds report

Print a funds report if you need a report showing the total number of mailpieces sent.

The funds report provides the following information about your device:

- **Used:** The total amount used over the lifetime of the device.
- **Available:** The amount currently available to print.
- **Total Pieces:** The total number of mailpieces run over the lifetime of the device.
- **Control Sum:** The control sum is the total of the amount used and available.
- **Batch Count:** The current Batch Count.
- **Batch Value:** The current Batch Total.
- **PBP Serial No:** The serial number of the device.
- The date and time the report was printed.

To print a funds report:

1. Tap **Envelope Printing** on the Home screen.
2. Tap the piece count in the upper right.
3. Tap **Print Report**.
4. Tap **SendPro C Envelope Printer**.
5. Insert an envelope into the device. The device prints the report.
6. Tap the **back arrow** to return to the Envelope Printing app.

6 - Mailing

In this section

Sending post by Standard Post.....	59
Key in Postage.....	59

Sending post by Standard Post

Send your letters and small parcels by Standard Post. Standard Post can be an economical way to send your post.

1. Tap **Envelope Printing** on the Home screen.
2. Tap **Account** and select an account if you use accounting.
3. Tap **Class**.
4. Tap **Start Over** to show a list of all the available classes.
5. Tap **New Zealand Post**.
6. Tap **Standard Post**.
7. Tap **Medium**.
8. Tap **Apply**.
9. Place the envelope on the scale. The weight appears.
10. Insert the envelope into the device. The device prints the postage.

Key in Postage

You can use your device to manually enter an amount of postage by selecting the **Key in Postage** option.

1. Tap **Envelope Printing** on the Home screen.
2. Tap **Account**, then select an account.
3. Tap **Class**.
4. Tap **Start Over** to display a list of all the available classes.
5. Scroll down and tap **Other Payments**.
6. Tap **Key in Postage**.
7. Tap the **0.01 - 500.00** or **500.01 - 999.99** desired tick box.
8. Enter the value of the mailpiece.
9. Tap **Apply** twice.
10. Insert the envelope into the device. The device prints the postage.

7 - Sealing

In this section

Filling the moistener tank.....	61
Sealing envelopes when you print postage.....	61
Sealing envelopes without printing postage.....	63
Avoiding envelope sealing issues.....	64

Filling the moistener tank

Your device will need refills of sealing solution in order to seal envelopes. Follow these steps to fill the moistener tank.

1. Check the level of sealing solution in your moistener tank **(1)**.



2. Add enough sealing solution to bring the sealant level up to the bottom of the fill hole **(2)**. Do not overfill the tank.
3. If the tank is empty, allow 30 minutes for the moistener brush and wick to get completely wet.

Sealing envelopes when you print postage

You can seal envelopes and print postage at the same time with your SendPro C Lite, SendPro C.

1. Check the level of sealing solution in the moistener tank. Add more if required.
2. Slide the envelope flap under the edge of the feed deck so the moistener can wet the flap.

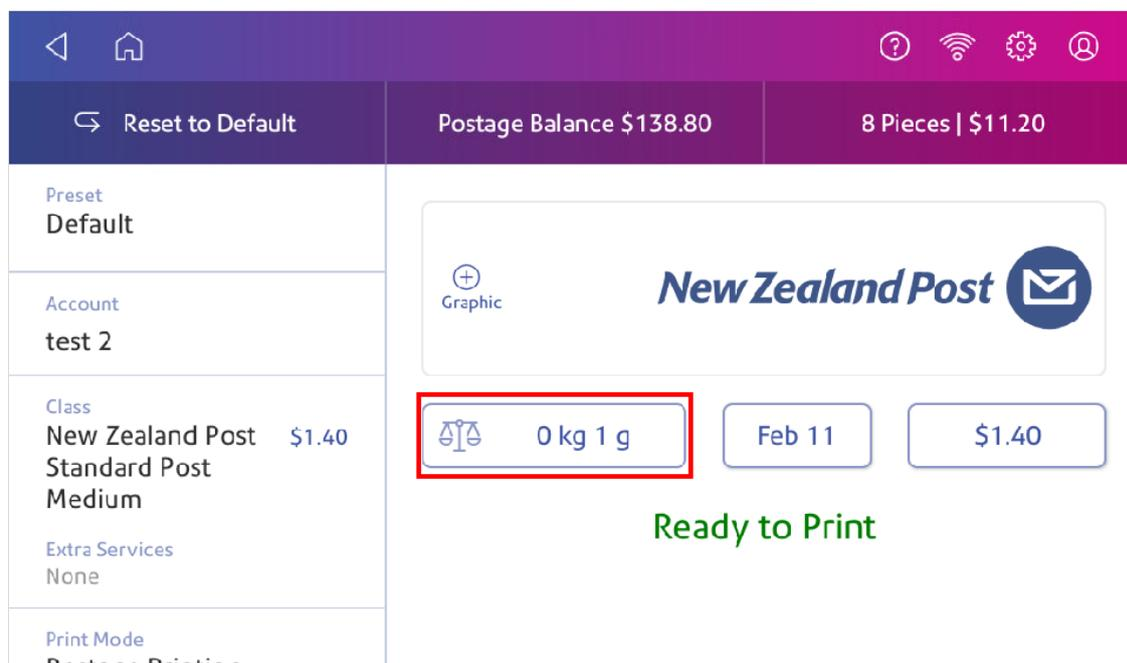

3. Tap **Envelope Printing** on the Home screen.
4. Tap **Account**, then select an account.

5. Tap **Weight**.

6. Tap **Scale**.
7. Place the envelope on the scale. You must do this before the next step or else **Apply** remains inactive.
8. Tap **Class** then select the class of mail you want.
9. Tap **Graphic** then select a graphic, if necessary.
10. Tap **Apply** to continue.
11. Insert the envelope into the device. The device prints the postage .

Important: If the moistener tank is full and your envelopes do not seal correctly, clean the moistener brush and wick.

Sealing envelopes without printing postage

Use Seal Only mode to seal envelopes without printing anything.

1. Tap **Envelope Printing** on the Home screen.
2. Tap **Print Mode**. You may need to swipe up on the screen to see this option.
3. Select **Seal Only**.
4. Tap **Apply**.

5. Place your envelope face up, flap down into the feeder. Be sure to slide the envelope flap under the edge of the feed deck.



6. Insert the envelope into the device. The device seals the envelope.



Avoiding envelope sealing issues

Prevent sealing issues by:

- Having enough sealant in the moistener tank.
- Placing the envelope correctly on the feed deck.
- Maintaining the wick or brush in the moistener.

1. Check the level of sealant in the moistener tank. Add more if required.

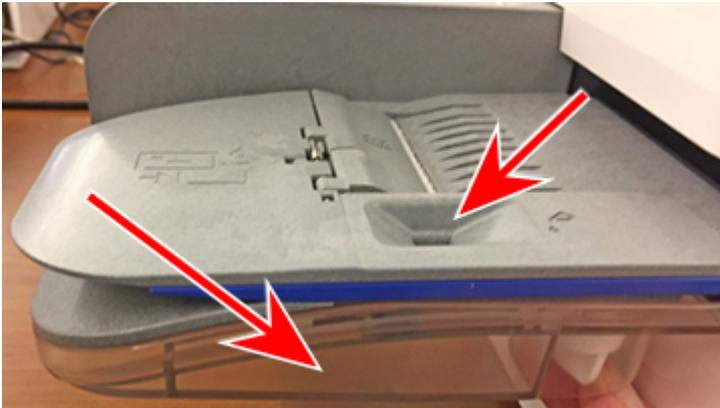

2. Slide the envelope flap under the edge of the feed deck when inserting an envelope. Otherwise, the moistener cannot wet the flap.



3. If the moistener tank is full, and your envelopes are still not sealing correctly, clean your moistener brush and wick.

8 - Printing

In this section

What are print modes.....	67
Printing a custom graphic.....	67
Printing a graphic without printing postage.....	68
Adding a custom text message.....	68
Adding an inscription.....	68
Printing only the date and time.....	69
Printing a test pattern.....	69

What are print modes

As well as printing postage, your device uses other ways to print and feed mail. Tap **Print Mode** in the Envelope Printing app to see the available options.

- **Date and Time Stamp** - Print just the date and time. Your device will not print any postage.
- **Graphic only** - Print a graphic. Your device will not charge you for printing a graphic only.
- **Postage printing** - Postage printing is the default mode for printing mail.
- **Seal only** - Seal your envelopes. Your device will not print when you select Seal Only.
- **Key in Postage** - Enter the price of your mail manually.

Printing a custom graphic

Customise your mail by adding a custom graphic or logo.

Add your own custom logo or graphics to your device. You can store up to 24 custom graphics.

1. Tap **Envelope Printing** on the Home screen.
2. Tap **Graphic**.

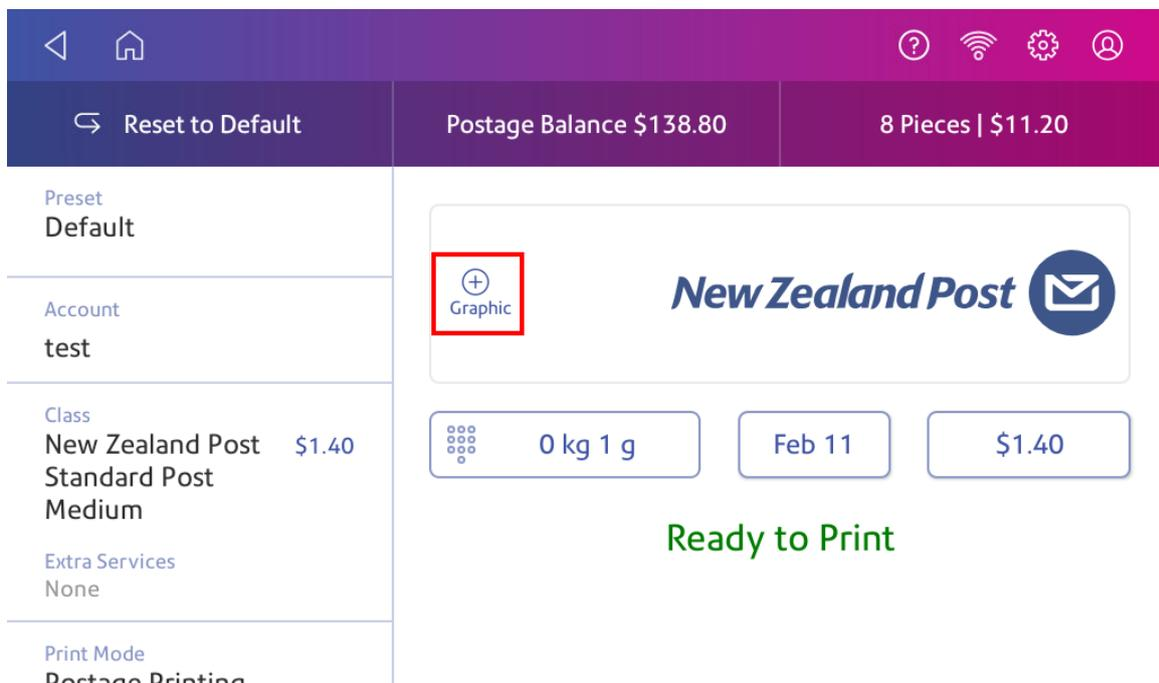

3. Select the graphic you wish to use.
4. Tap **Apply**.
5. Place the envelope on the feed deck then manually feed it through the device.

To order a custom graphic, contact your device supplier.

Printing a graphic without printing postage

Print a graphic without printing postage, such as the Received graphic on incoming mail.

1. Tap **Envelope Printing** on the Home screen.
2. Tap **Print Mode**.
3. Select **Graphic Only**.
4. Tap **Apply**.
5. Tap **Graphic**.
6. Tap **Graphics**, then select your graphic.
7. Confirm with **Apply**.
8. Print the graphic on the envelope or tape.

Adding a custom text message

Add a text message to print a return address or to print your own personalised message. Your message must comply with the postal rules for your country.

Your message can be up to five lines, with 20 characters per line. The message prints on the left side of the envelope.

1. Tap **Envelope Printing** on the Home screen.
2. Weigh your envelope, select a class, and select special services, if required.
3. Tap **Graphic +**.
4. Tap **Custom Text**.
5. Tap **+ Add**.
6. Tap **Accept & Continue** to comply with the postal rules.
7. Enter a name for the message. The name can be up to 20 characters.
8. Tap **Save**.
9. Enter the message, line by line.
10. Tap **Apply** twice.

Adding an inscription

Inscriptions appear automatically when you select certain classes of international mail. This saves you time and helps you always use the correct inscription.

For example, select International Air mail. The International Air inscription will print automatically on your mail.

Printing only the date and time

Print the date and time to keep a record of when you receive incoming mail.

1. Tap **Envelope Printing** on the Home screen.
2. Tap **Print Mode** (you may have to scroll down to see this).

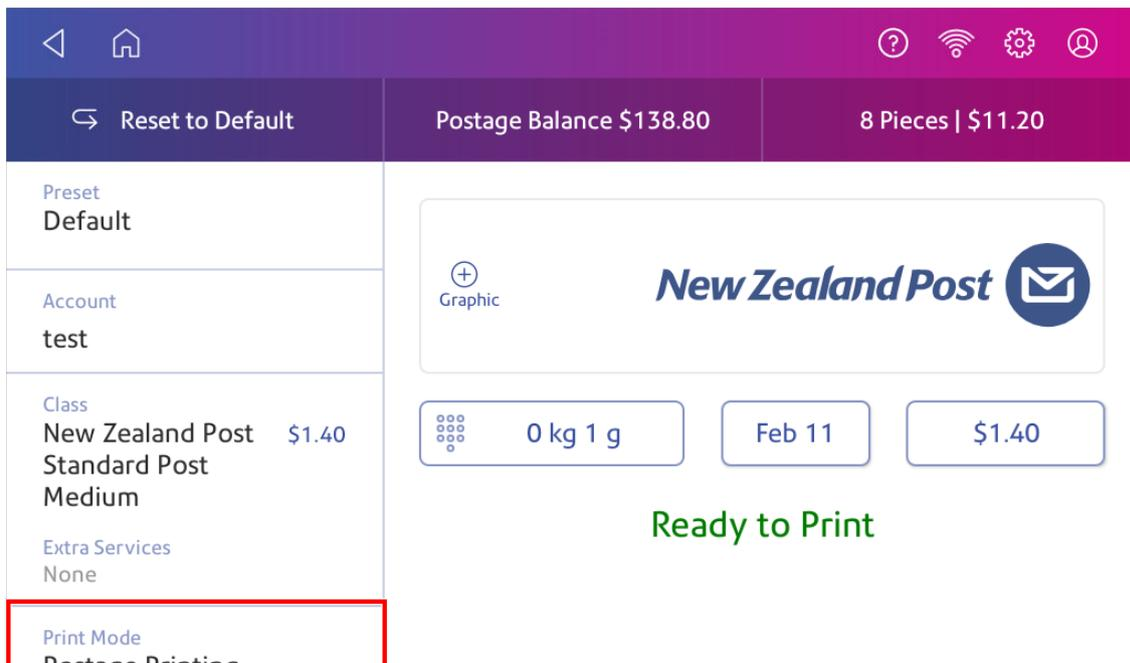

3. Select **Date and Time Stamp**.
4. Tap **Apply**.
5. Insert the envelope into the device. The device prints the envelope.

Printing a test pattern

Print a test pattern to see if the printhead is working properly or if you have enough ink in the cartridge.

1. Tap **Settings**.



2. Scroll down and tap **Envelope Printer Maintenance**.
3. Tap **Print Test Pattern**.
4. Insert the envelope into the device when the message "Print a Test Pattern?" appears.

5. Examine the pattern printed on the envelope:

- Tap **Done** if the lines are unbroken and match the "Good" test pattern shown on the display.
- Tap **Clean Printhead** if the test pattern has missing or incomplete lines
 - Once the cleaning operation completes, you must print another test pattern.
 - If this new pattern still has broken or missing lines, you may need to replace the ink cartridge or clean or replace the printhead.
 - If you see no improvement in print quality, do not repeat the cleaning, as cleaning the print nozzles consumes ink.

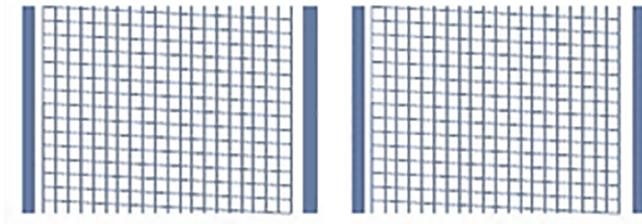

Good Test Pattern

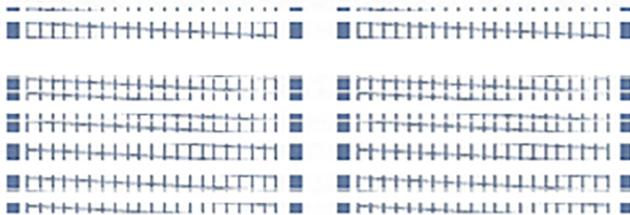

Bad Test Pattern

9 - Feeding and Jamming

In this section

Preventing envelope feeding problems.....	72
---	----

Preventing envelope feeding problems

Ensure you feed envelopes correctly to help prevent feeding problems.



Feeding mail

1. For your first envelope, hold the far edge of the envelope against the back wall of the feeder.
2. Slide the envelope into the feeder until you feel it touch the rollers. You hear the motor begin. Do not release the envelope until the feeder grabs it to pull it through the device.



3. You hear the motor continue to run for about 5 seconds once it prints postage on the envelope.
4. Continue to insert envelopes one at a time. Make sure you press the edge of each envelope against the back wall of the feeder and into the feeder until it touches the rollers.
 - Make sure the envelopes fully exit the feeder and do not pile up on the edge of the feeder.
 - If you are using a stacker, you may need to extend the stacker tray so that the envelopes exit the feeder completely.

Hold the envelope against the back wall to avoid skews

If you don't hold the envelope against the back wall it can skew. A skewed envelope can either exit the device with no postage applied or cause a jam. The message Clear Paper Jam appears. This could deduct funds. Even a minor skew that may be difficult to see can cause a jam.

Cleaning the feeder

Using a can of non-flammable compressed air, blow on the feed deck on the left side and work toward the transport deck on the right side of the device. Make sure to remove all the dust and debris.

10 - Ink

In this section

Checking the ink level.....	75
Ordering ink cartridges.....	75
Replacing the ink cartridge.....	76

Checking the ink level

Check the ink level to ensure you have enough ink in your device.

1. Tap **Settings**.



2. Scroll down and tap **Envelope Printer Maintenance**.
3. View the level of remaining ink.

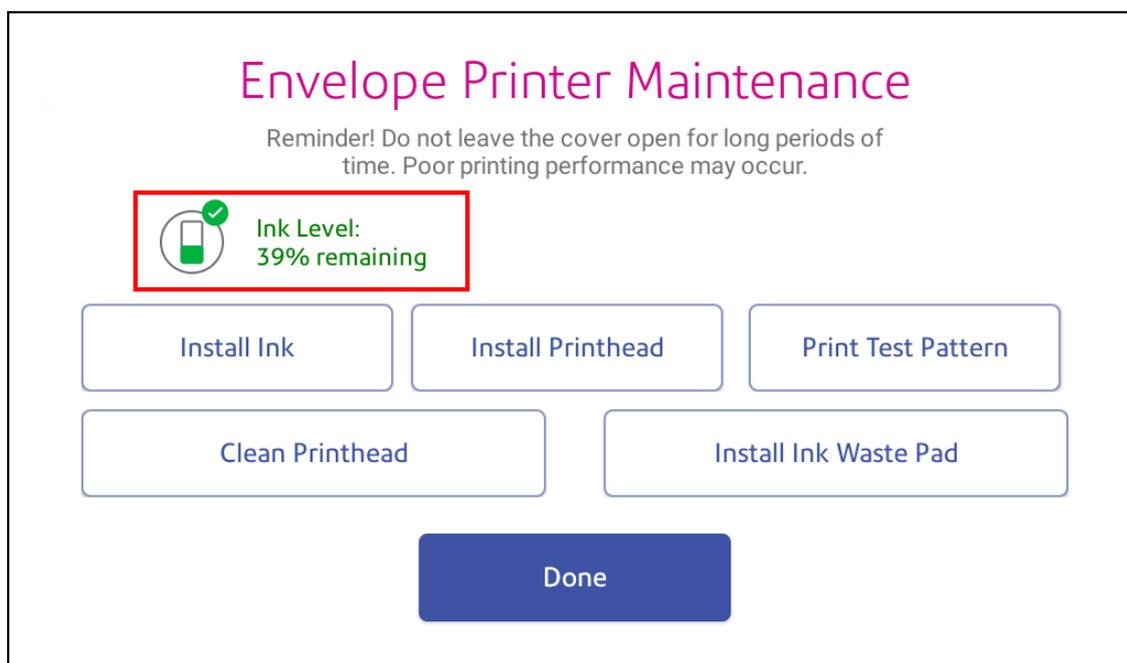

4. Tap **Done** to exit the screen.

Ordering ink cartridges

Use postal approved ink cartridges. Non-postal approved ink cartridges can damage your device.

Visit <https://www.pitneybowesdirect.co.nz> to order ink cartridges for your device.

Replacing the ink cartridge

Replace the ink cartridge when the low ink warning appears. This ensures your device is in optimal working condition.

1. Tap **Settings**.



2. Scroll down and tap **Envelope Printer Maintenance**.
3. Tap **Install Ink**.
4. Lift the top cover. The ink cartridge moves to the front position.
5. Remove the ink cartridge, as shown on the label next to the cartridge holder.

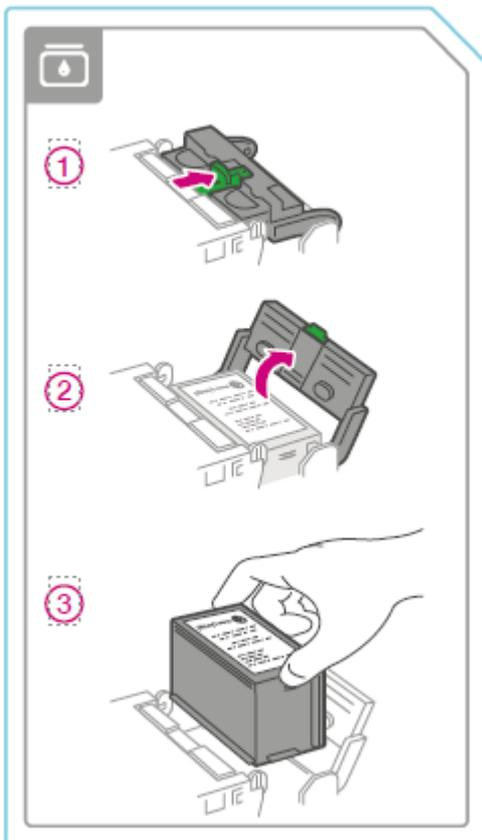

6. Insert the new ink cartridge, then close the ink cartridge guard.

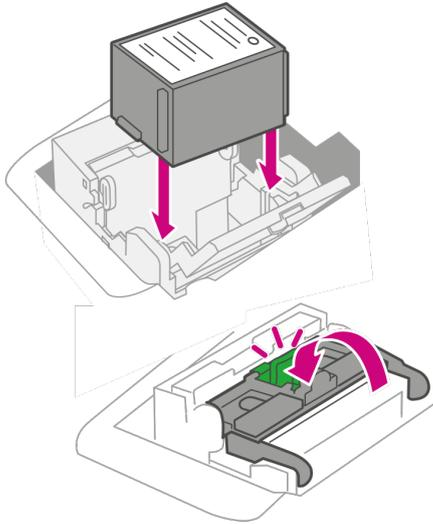

7. Close the top cover.

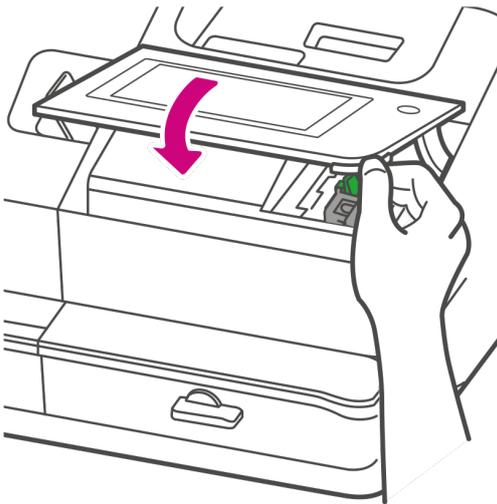

8. The cartridge repositions itself and the Envelope Printer Maintenance screen appears.
9. Print a test pattern to ensure that your ink cartridge installs properly.

11 - History and Reports

In this section

Running account reports.....	79
Setting the report period for an account.....	79
Setting the account report preferences.....	80
Emailing an account report.....	81
Viewing the total spent on printing postage.....	83

Running account reports

Run account reports to show how you spent your postage for a specific account or for all accounts over various time periods.

1. Tap **Envelope Printing** on the Home screen.
2. Tap **Account**.
3. Tap **Preferences**.



4. Tap **Manage Accounts**.
5. Tap **Reports**.
6. If this is the first time you are running a report:
 - a. Tap **Report Period** and set the time range for your reports.
 - b. Tap **Preferences** and set how you wish to identify the accounts.
7. Set the report period.
8. Tap **View & print reports**.
9. Tap to select a report.
10. Tap **Next**.
11. Choose what to do with the report:
 - To view the report on the screen, tap **View Report**.
 - Tap **Actions** to save the report under a new name, delete, print, or email the report.

Setting the report period for an account

Set the reporting period of an account report by setting its start and end dates.

1. Tap **Envelope Printing** on the Home screen.
2. Tap **Account**.
3. Tap **Preferences**.



4. Tap **Manage Accounts**.
5. Tap **Reports**.
6. Tap **Report period**.

7. Select the calendar image next to the **Start date of fiscal year** field.

Report period defaults

Start date of fiscal year:
01-01-21

End date of fiscal year:
31-12-21

Default reporting period:
Calendar month

Calendar month periods for 2021:

Month 1	01-01-21 to 31-01-21
Month 2	01-02-21 to 28-02-21
Month 3	01-03-21 to 31-03-21
Month 4	01-04-21 to 30-04-21
Month 5	01-05-21 to 31-05-21

< Previous year Next year >

OK

- a. Select a date on the calendar.
 - b. Select **SET**.
- The End date of the fiscal year is set based on the start date you enter. You cannot enter this date manually.
8. Select the **Default reporting period** field.
 - a. Select a report period type.
 - b. Select **OK**.
 9. (Optional) Tap **Previous year** and **Next year** to view the reporting periods for the previous and next year. Tap **up** and **down** to scroll through the list of reporting periods for the current year.
 10. Tap **OK** to return to the Reports screen.

Setting the account report preferences

Set the account report preferences to select the account level you wish to report on (Account, Sub account or Sub sub account).

You can also choose how you want to identify accounts: by Name or by Code.

1. Tap **Envelope Printing** on the Home screen.
2. Tap **Account**.

3. Tap **Preferences**.



4. Tap **Manage Accounts**.
5. Tap **Reports**.
6. Tap **Preferences**.
7. Tap to select how you want to identify accounts: by **Name** or by **Code**.
8. Select the account level you wish to report on: **Account**, **Sub account** or **Sub sub account**.
9. Tap **OK** to return to the Reports screen.

Emailing an account report

Email an account report to keep a record of how much departments or clients have spent on their postage over specific time periods.

1. Tap **Envelope Printing** on the Home screen.
2. Tap **Account**.
3. Tap **Preferences**.



4. Tap **Manage Accounts**.
5. Tap **Reports**.
6. Tap **View & print reports**.
7. Tap the report to select it.
8. Tap **Next**.
9. Tap **Actions** or **View Reports** at the bottom of the screen.

10. Tap **Email Report**.

Period:
Current Period
Start: 01-05-22
End: 31-05-22

Meter(PSD):
1H20-8000018

Save as Save Delete report Print report

Email Report

Actions Cancel Back View report

11. Tap in the **Please enter the recipient mail address** box and enter the recipient's email address. The email address you enter will remain until you turn off then turn on the device.

* Please enter the recipient mail address:

* Attach report as file type:

.xlsx

.csv

.pdf

* Required fields

Cancel Send

12. Tap the file type you wish to send: **xlsx** (Excel), **csv** (comma-separated values), **pdf** (Portable Data Format).13. Tap **Send**. The report appears from no-reply@pb.com.

Viewing the total spent on printing postage

View the total amount you have spent on postage and the total number of pieces printed.

1. Tap **Settings**.



2. Scroll down to the Envelope Printer Settings section.
3. Tap **Postage Refills**.
4. Tap **Advanced** to view the total amount of postage spent and the number of pieces printed.

12 - Settings

In this section

What are presets.....	85
Adding presets.....	85
Selecting a preset.....	86
Modifying presets.....	86
Setting the default preset reset timer.....	87
Using SendPro Apps.....	88
Adding favourite apps.....	89
Using the SendPro Care app.....	90
Using the Toolbar.....	90
Adjusting display brightness.....	91
Setting up the Energy Saver.....	91
Creating or disabling the security PIN.....	92
Adjusting time zone and scale location code.....	93
Advancing the date.....	93
Uploading postage transactions.....	94
Clearing or resetting the number of mailpieces sent.....	95

What are presets

A preset is a group of commonly-used settings that you use to quickly select the same settings in the future. Presets can store settings such as a postage class, an account and a graphic. The maximum number of presets you can create is eleven. This includes the default preset.

Your device adds a default preset automatically once the installation is complete. You can edit the default preset to suit your own settings.

When your SendPro C Lite, SendPro C enters sleep mode or when you switch it off, it also reverts to the default preset.

Adding presets

Add presets to store a group of commonly-used settings. Presets can store settings such as a postage class, an account and a graphic. The maximum number of presets you can have is eleven. This includes the default preset.

1. Tap **Envelope Printing** on the Home screen.
2. Tap **Class**, select the class and any special services, messages or graphics.
3. Verify the settings on the Envelope Printing app.
4. Tap the star in the Preset box.

Important: You must modify something in the Envelope Printing app for the Preset star to appear.

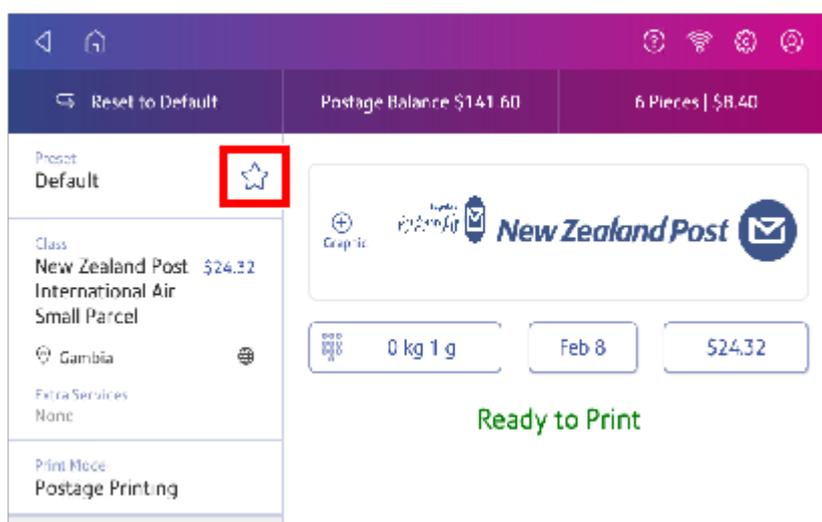

5. Tap **Save New Preset** to save it. If you wish to save it and replace the default setting, tap **Replace Default Preset**.

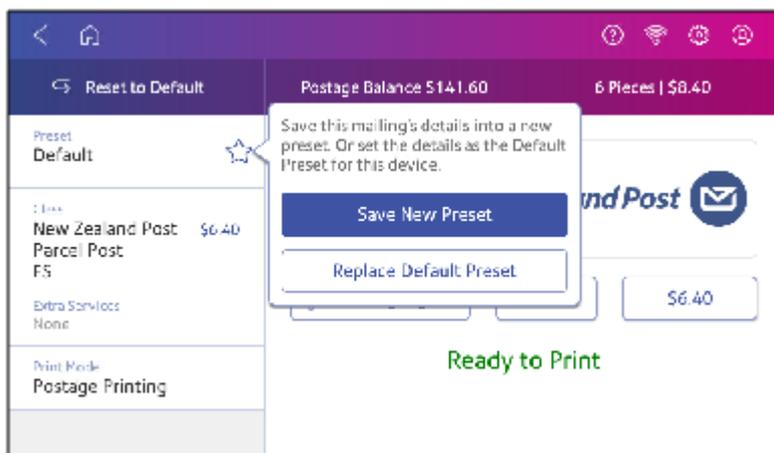

6. For a new preset, enter a name, then tap **Save**.

Important: Make sure there is nothing on the scale when you create the preset as the device will also save the weight of the mailpiece.

Selecting a preset

Select a preset to quickly select a commonly-used group of settings.

1. Tap **Envelope Printing** on the Home screen.
2. Tap **Preset**.
3. Tap the preset you want to use, then tap **Apply Preset**.

If you select a preset and do not use it within about one minute, the Envelope Printing app restores the default preset values. The same is true when you switch your device off or it enters sleep mode.

Modifying presets

Modify a preset to rename a preset, replace the default preset or delete a preset.

1. Tap **Envelope Printing** on the Home screen.
2. Tap **Preset**.
3. Tap the preset you wish to modify.

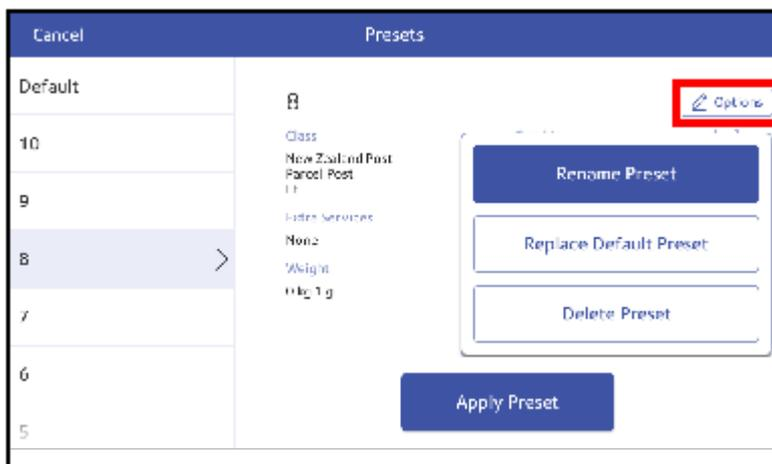
4. Tap **Options**.

5. Tap the option you want.

Setting the default preset reset timer

The default preset timer will reset your device to your most commonly-used settings. By default, the preset timer resets your device after one minute of inactivity. You can change this time if necessary.

1. Tap **Settings**.

2. Scroll down to the Envelope Printer Settings section.
3. Tap **Postage Refills**.
4. Tap **Default Preset Timer**.

5. Use the slider to set the time between 1 and 9 minutes.

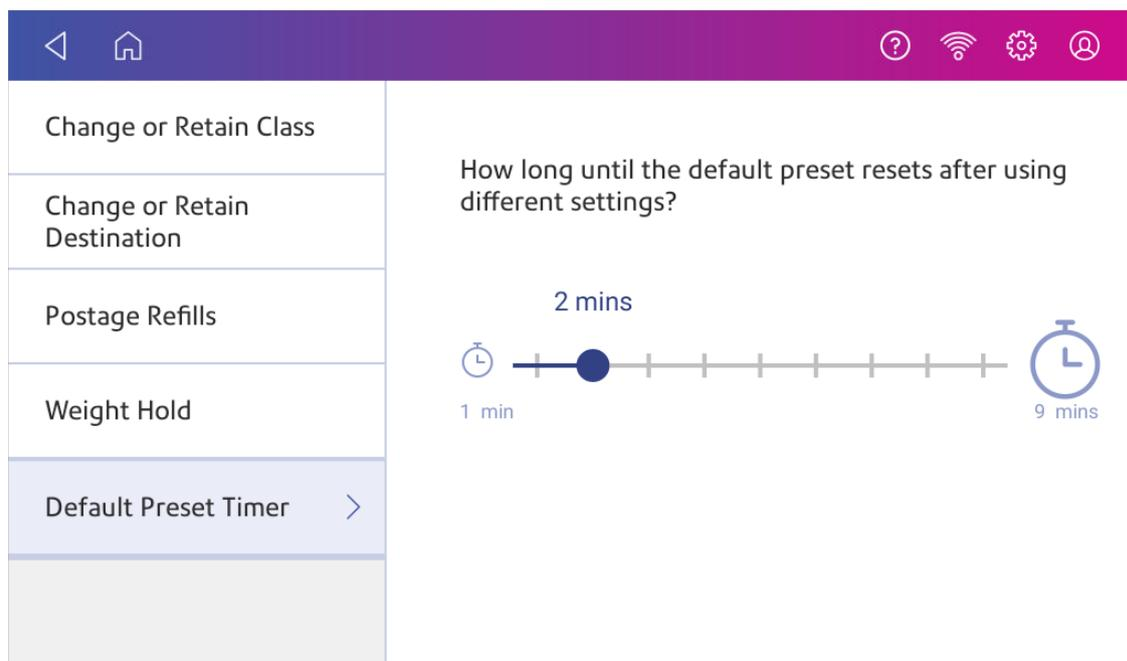

6. To save the value and exit the screen, tap the **back arrow** or **Home**.

Using SendPro Apps

Tap SendPro Apps on the Home screen to access a variety of apps that support your device.

For example, you can:

- Check you have the latest rates and software installed on your device using Rates and Updates.
- Print a receipt when you add postage funds using Print Refill Receipt.

- Check the connection to the internet using Network Connection.

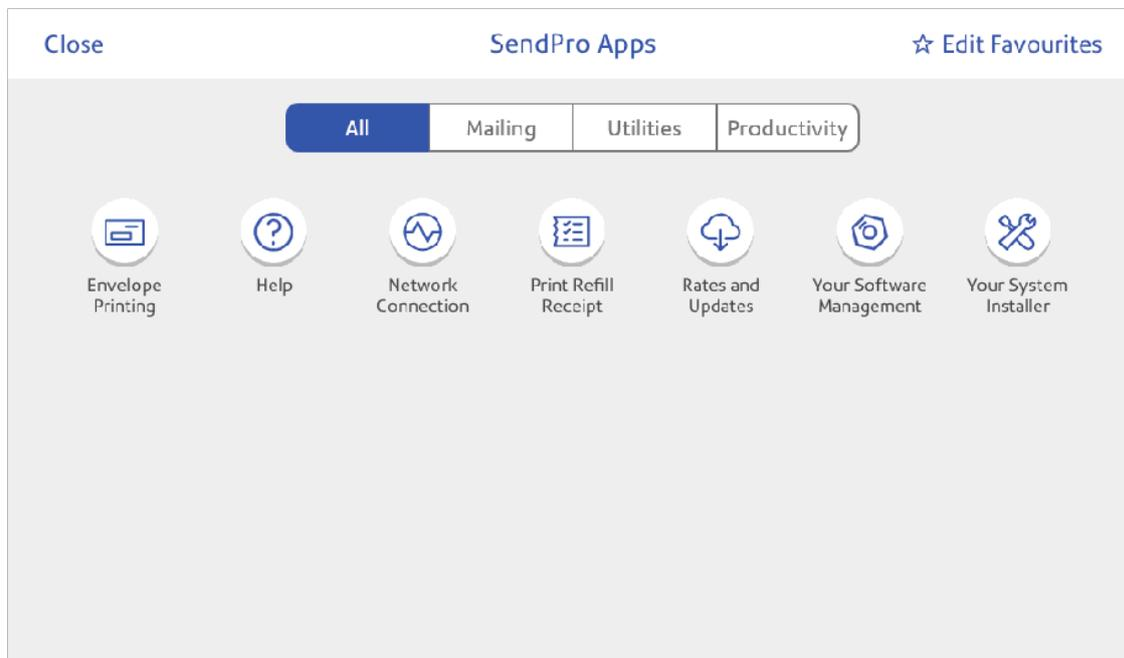

Adding favourite apps

Add your favourite apps to make them easy to find on the Home screen.

1. Tap **SendPro Apps** on the Home screen. All the available apps display.
2. Tap **Edit favourites** and a star appears next to each app.

3. Tap the star next to an app to make it a favourite.

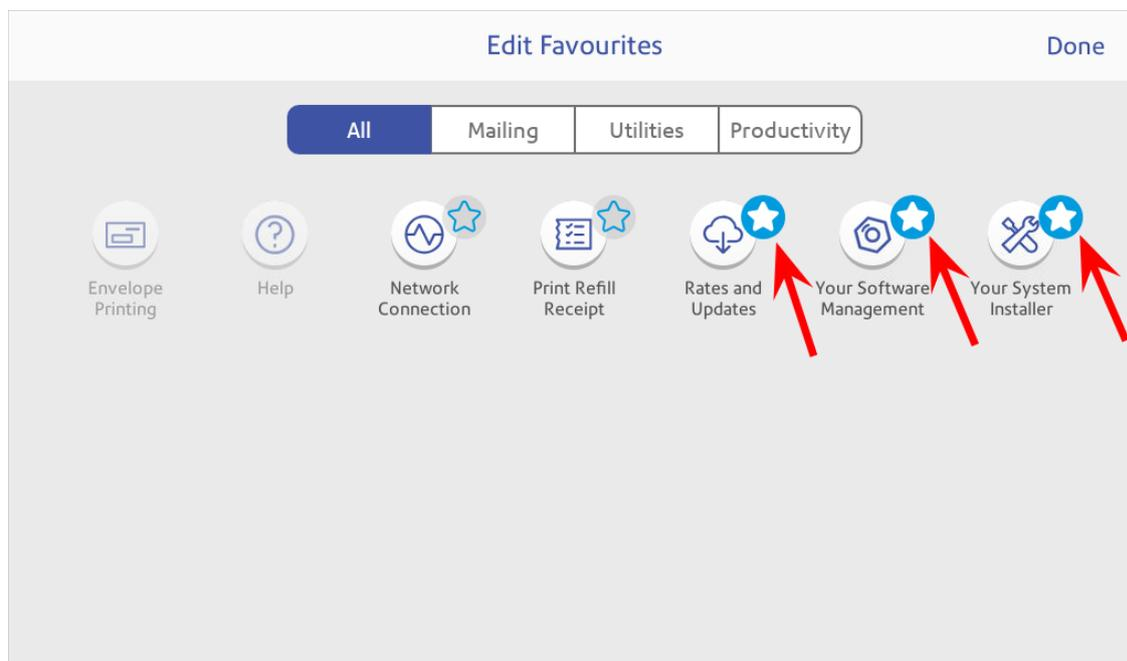

4. Tap **Done** when complete.

Using the SendPro Care app

Tap **Ask SendPro Care** on the Home screen to get information and help for your device. This includes:

- Viewing alerts.
- Get information about your device- your account number, serial number and model number.
- Any error messages on your device, like "Cover open" or "Low Funds".
- A list of the most popular searches.
- Access to PDF operator guides.

Using the Toolbar

The toolbar is located at the top of every screen.

Use the toolbar to:

- View and change settings and default values for your device.
- View online help.

- View information for your network type and wireless signal strength.



1. **Back** - Return to the previous screen.
2. **Home** - Return to the Home screen from any screen.
3. **Support** - Search support content and get help on how to perform tasks.
4. **Network** - View the current network type (wireless or wired) status and strength (for wireless connection). Allows you to turn wireless connection on or off. The icon here shows a wireless connection.
5. **Profile** - Lock your device when you have enabled the security PIN.
6. **Settings** - View or change your device and app settings. This includes changing the screen brightness, setting sound levels, and viewing wireless or wired connection information.

Adjusting display brightness

Set the brightness of the display to suit your work space.

1. Tap **Settings**.



2. Tap **Display Brightness** in the Device & Network section of the screen.
3. Move the slider to adjust the brightness.
4. Tap the **back arrow** or **Home** image to exit the Settings screen.

Setting up the Energy Saver

Use the energy saver to reduce energy usage. The energy saver turns your device off after a period of inactivity.

1. Tap **Settings**.



2. Tap **Energy Saver** in the Device & Network section.
3. Tap in the **Time after inactivity to turn off** field.
4. Select the amount of time you want your device to remain inactive before it shuts down. The shorter the time you select, the more energy you save.

Creating or disabling the security PIN

Create a security PIN to prevent unauthorised use of your device.

If you created a security PIN when you installed your device, you must enter it when you turn your device on or after it enters sleep mode.

Create a security pin

1. Tap **Settings**.



2. Tap **Security PIN** in the Device & Network section.
3. Tap **Create PIN**.
4. Enter a 4-digit numeric PIN using the keyboard on the display.
5. Verify your PIN by entering it again.

Change or disable the security PIN

1. Tap **Settings**.



2. Tap **Security PIN** in the Device & Network section.
3. Tap **Change PIN** or **Turn OFF Security PIN**.
4. Enter the current security PIN for either option.

Manually lock your device

1. Tap the user profile image.



2. Tap **Lock this device**. The screen saver displays shortly after the Device is Locked screen appears.

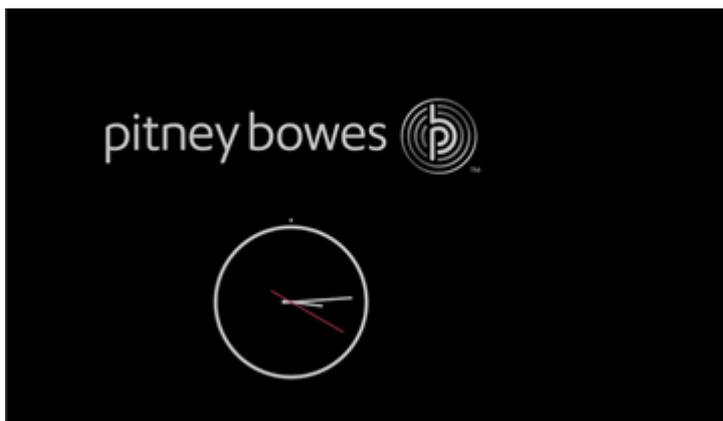

If you forget your Security PIN, tap on the **Forgot PIN?** link to get help.

Adjusting time zone and scale location code

When you move your device to a new location or install a new scale, you must modify the location code.

1. Tap **Settings**.



2. Tap **Location & Time Zone**.
3. Enter the new location code. Tap **Help me find my scale location code** or see the list of location codes in the related topics section.
4. Tap **Apply**.

Advancing the date

Advance the date to print postage up to thirty days before you need to send it.

1. Tap **Envelope Printing** on the Home screen.
2. Tap the date. The calendar appears.
3. Tap **Tomorrow** or **Another Date**, depending on the date you wish to print.
4. When you see the future date highlighted on the calendar, tap **Apply**.
5. Insert the envelope into the device. The device prints the postage.

Important: The date on the postage should match the date when your mail goes to the post office. Your device automatically advances the printed date on the device stamp (as well as its internally held date) when the device time reaches 5:00 PM. You cannot change this time.

Uploading postage transactions

Automatic upload of your postage transactions

- Your device automatically uploads your postage transactions to the Pitney Bowes Data Center. This occurs at least once during the day and once after hours.
- If you lock your device or turn it off for any extended period, it automatically uploads your transactions when you turn it on again.
- If you see the message "Sync your data", it means you need to upload your transactions.

Important: If your device had connection issues recently, it may require multiple uploads to upload transactions. If the device prompts you to upload more than three times, please contact technical support.

Manual upload of your postage transactions

1. Tap **Settings**.



2. Scroll down to the Envelope Printer Settings section.
3. Tap **Sync Transaction Data**.
 - A series of messages appear, starting with "Preparing Transaction Data" followed by "Sending Transaction Data."
 - Once the upload is complete, the message "Transaction Data Sent" appears.
 - The message "No Sync Required" appears if there are no new transactions to upload.

Clearing or resetting the number of mailpieces sent

Reset the piece counter to delete the piece count information.

Make certain that you wish to delete the piece count information. Once you do so, you cannot restore the deleted data.

1. Tap **Envelope Printing** on the Home screen.
2. Tap **Pieces**.
3. Tap **Reset Counter to 0**.

13 - Rate Change

In this section

Updating postal rates or software.....	97
--	----

Updating postal rates or software

Update software and rates automatically

Your device updates postal rates and software automatically.

Keep your device turned on and connected to the internet to receive automatic updates. The device downloads updates during the evening hours.

Check for rate or software updates manually at any time

Even though your device checks for updates automatically, you can check for rate and software updates at any time.

1. Tap **SendPro Apps**, then tap **Rates and Updates**.
2. If new rates are available, your device downloads and installs the updates.

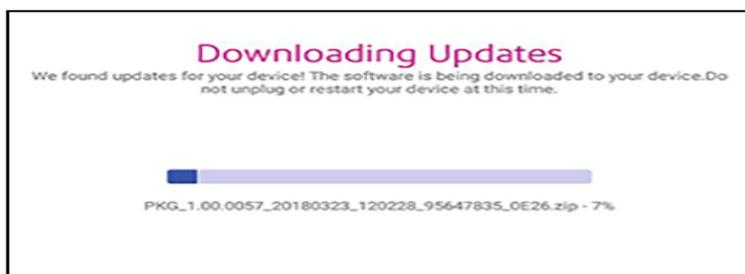

3. Once the download and install process completes, the message "Updates successful" appears.



14 - Maintenance

In this section

Cleaning the Printhead.....	100
Cleaning the moistener brush and wick assembly.....	100
Moving the SendPro C Lite, SendPro C.....	104
Ordering supplies.....	104

Cleaning the Printhead

Clean the printhead nozzles if you get a bad quality test print pattern, to try to correct the problem.

1. Tap **Settings**.



2. Scroll down to the Envelope Printer Settings section.
3. Tap **Envelope Printer Maintenance**.
4. Tap **Clean Printhead**.
5. Once the cleaning operation completes, the device prompts you to print another test pattern. If the new pattern still has broken or missing lines, you may need to replace the ink cartridge or printhead.

Cleaning the moistener brush and wick assembly

Clean the moistener brush and wick if the moistener tank is full and your envelopes are not sealing properly.

1. Unscrew the plastic thumbscrew under the moistener base.



2. Lift the moistener brush assembly off the top of the moistener base.



3. Turn the assembly over and slide the moistener brush out of the holder.

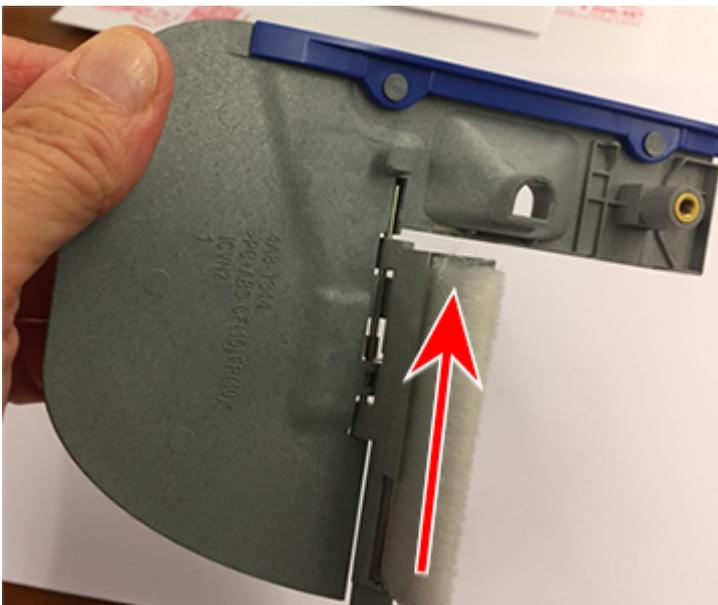

4. Locate the wick on the moistener base.

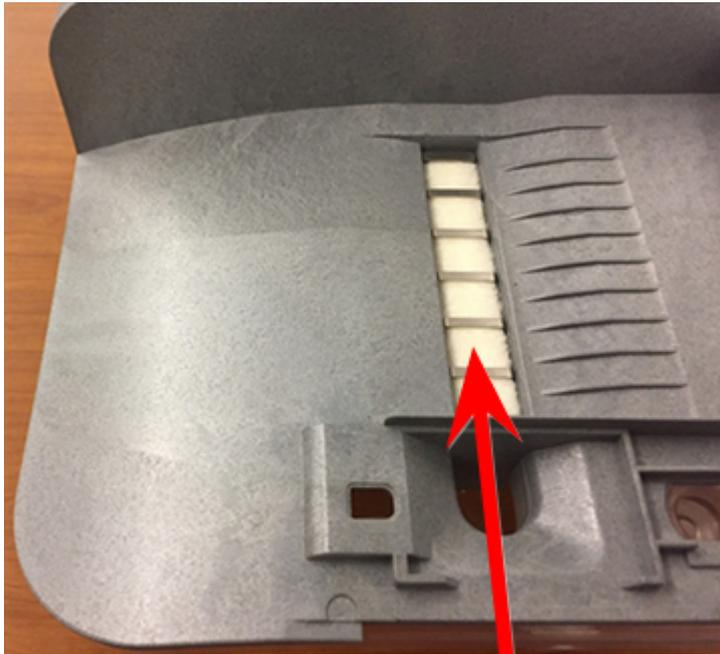

Wick

5. Remove the metal grate and wick from the moistener base.



6. Clean the brush and wick with water and rinse thoroughly.

7. Place the wick back in the metal grate and replace the grate in the moistener base.
8. Slide the moistener brush back into the holder.
9. Replace the moistener brush assembly on top of the moistener base and secure with the plastic thumbscrew.

Moving the SendPro C Lite, SendPro C

Move your device safely, whether you are moving it across the room or to a new facility.

1. If you have a scale, remove it from the device.
2. Remove the moistener assembly. Once you have removed and cleaned the assembly, place it in a zip-top bag to prevent any remaining fluid from leaking.
3. Remove the ink cartridge. Once you get the ink cartridge out, place it in a zip-top bag.
4. Close the top cover.
5. Remove all USB cables and optional devices such as scanners. Pack them with the device.
6. Unplug the power cord and pack it with the device.
7. Once in the new location, re-install all USB cables and devices.
8. Plug the power cord into the device and power outlet.
9. Re-install the ink cartridge.
10. Re-install the moistener assembly.

Ordering supplies

Visit <https://www.pitneybowesdirect.co.nz> to order supplies for your device.

15 - Product Information

In this section

Navigating the Home screen.....	106
Navigating the Envelope Printing app.....	107
Parts of a meter stamp.....	108
Postal Security Device.....	108
Parts of the SendPro C Lite, SendPro C.....	109
Connections on the back.....	110
Specifications.....	110
Material specifications.....	113
Lithium ion battery.....	116
Agency compliance information.....	116
Scale Safety.....	118
Contacting Pitney Bowes.....	118
Third party software.....	119

Navigating the Home screen

The Home screen on the SendPro C Lite, SendPro C provides the starting point for printing postage.

Tap the Home icon in any screen to return to the Home screen.

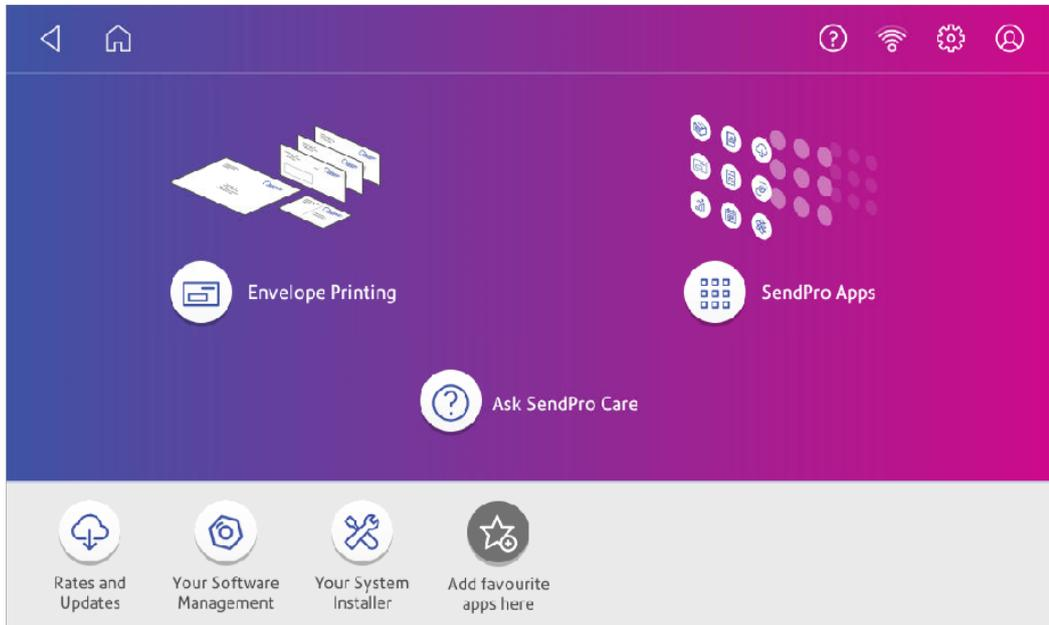

- Tap **Envelope Printing** to print envelopes, post cards and small parcels.
- Tap **SendPro Apps** to view additional apps.
- Tap **Ask SendPro Care** to get information and help for your device.

Toolbar

The toolbar located at the top of the Home screen appears at the top of every screen. It allows you to view and change settings for your SendPro C Lite, SendPro C.



1. **Back** - Return to the previous screen.
2. **Home** - Return to the Home screen from anywhere in Envelope Printing.
3. **Support** - Search support content and get information on how to use the Envelope Printing app.
4. **Network** - View the current network type (wireless or Ethernet) and status and strength (for wireless connection). The image here represents a wireless connection.
5. **Settings** View or change your device settings. This includes adjusting the screen brightness, setting sound notification levels, and viewing wireless or Ethernet connection information.
6. **Profile** - Lock your device when you enable the security PIN.

Navigating the Envelope Printing app

The Envelope Printing app is the starting point for printing postage on an envelope or a tape. It also allows you to change what you print. It also allows you to change what you print.

Tap **Envelope Printing** on the Home screen to open the app.

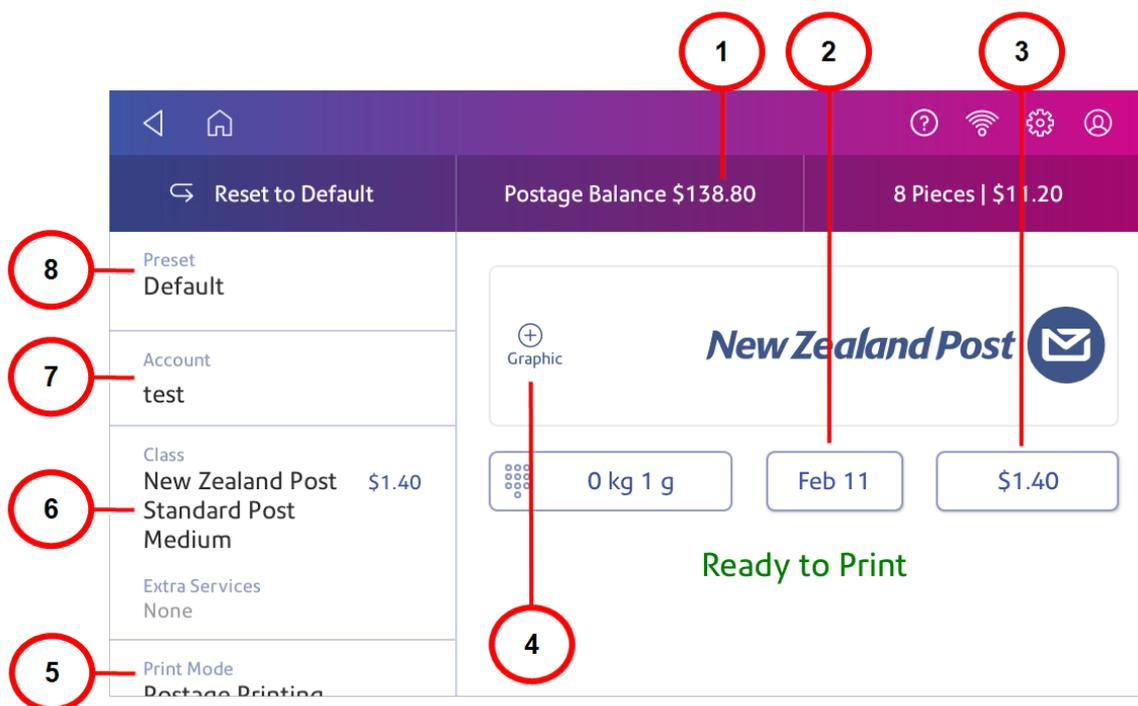

On this screen, you can:

1. View **Postage Balance** - View the balance of funds you have left in your device.
2. View **Date** - Tap the date to view the date options.
3. View **Total postage amount** - View the total postage amount.

4. Print **Graphic** - Tap **Graphic +** to preview or add graphics. You can also add a custom text message.
5. View **Print Mode** - View the available printing modes such as printing a graphic only, printing the date and time, or seal envelopes without printing postage.
6. View **Class** - Tap **Class** to view available postal classes and any extra services.
7. View **Account** - Tap **Account** to charge back postage to departments or clients, and run reports showing how you spent your postage over specific time periods.
8. View **Preset** - Tap **Preset** to store a group of commonly-used settings. Presets can store settings such as a postage class, an account and a graphic.

Parts of a meter stamp

The meter stamp contains elements that identify the mailer and the type of mail. Optional parts include advertising graphics and logos.



1. Postage amount.
2. Data matrix barcode - contains postage and tracking information.
3. Piece count.
4. Device serial number.
5. Post code.

Postal Security Device

The postage meter on your mailing system is a Postal Security Device (PSD) that secures your postage funds. It includes the latest technology approved by New Zealand Post. This technology eliminates the need for New Zealand Post to perform physical inspections, thereby making your device easier and more convenient for you to use.

Parts of the SendPro C Lite, SendPro C

Familiarise yourself with the parts of your SendPro C Lite, SendPro C.



1. **Integrated scale** - Weigh envelopes and parcels.
2. **Colour touchscreen display** - Process envelopes and packages.
3. **Ink access cover** - Allows access to the ink cartridges. Find the model and serial numbers inside.
4. **Paper jam lever** - If a stall occurs on the transport deck, turn this to clear the envelope, post card or tape strip.
5. **Envelope moistener** - Moistens the flap on the envelope.
6. **Semi-automatic feeder** - Feeds and seals envelopes. Also feeds postcards and tape strips.

Connections on the back

Familiarize yourself with the ports on the back of your device.

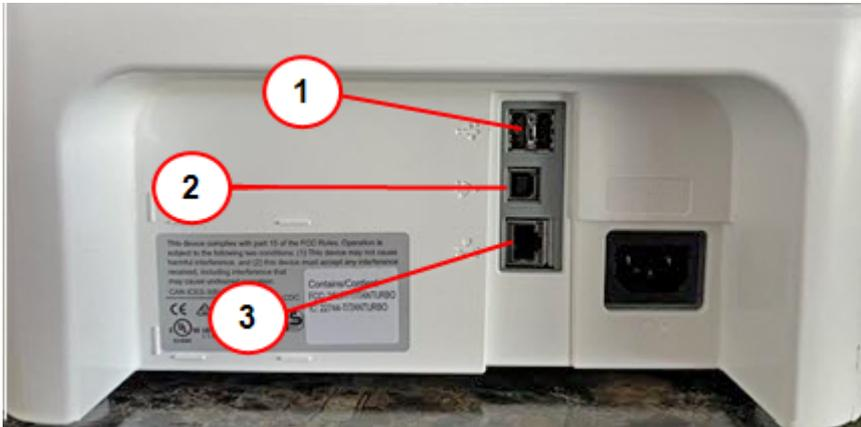

1. **USB port type A host** - Connect a Barcode scanner or external scale to these ports.
2. **USB port, type B host** - Service personnel use only.
3. **RJ45** - Use for a wired network connection.

Specifications

Review the specifications of your SendPro C Lite, SendPro C including the throughput, ink cartridge yield and other component details.

Power requirements

100-240 VAC, 50/60 Hz, 1.0 A

Operating Temperature

13°C to 35°C

Sound Level

Less than or equal to 70 dBA re 20 micro Pascal in accordance with ISO 7779, ISO 3744, or ISO 3741.

Dimensions

419 mm L x 394 mm W x 286 mm H



Weight

8 kg

Throughput (Letters Per Minute)

- SendPro C® Lite - 50 letters per minute
- SendPro C®, SendPro®+ - up to 65 letters per minute

Actual throughput varies, depending on the material used, device condition, use of moistener, etc.

Ink Cartridge Life

- 35 ml cartridge - yields up to 3,000 impressions. (Actual ink yields vary with usage and environmental conditions).

Ports

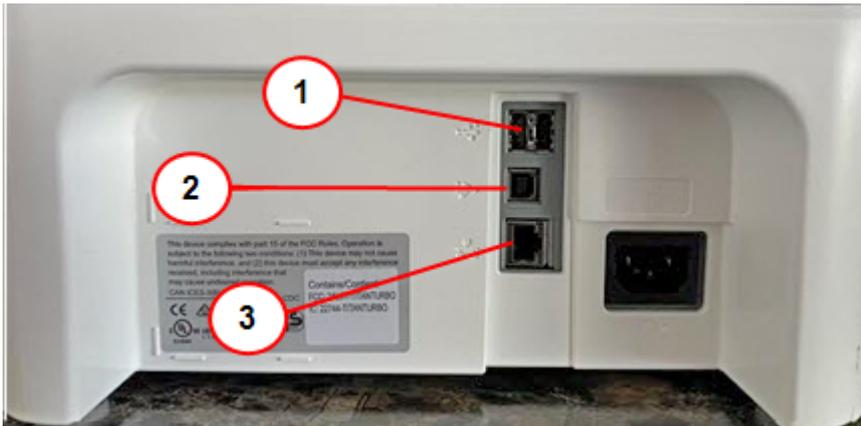

1. **USB port type A host** - Connect a Barcode scanner or external scale to these ports.
2. **USB port, type B host** - Service personnel use only.
3. **RJ45** - Use for a wired network connection.

Display

7-inch tablet (169 pixels/inch)

Print Resolution

300 H x 600 V dpi

Print Image Area

25.4 mm x 180 mm

Tapes and Strips

Self-adhesive, dual tape strip for use on mailpieces that are too large to run in the device. Ideal for adding postage to oversized envelopes, priority mail and packages.

Postal Inscriptions

Up to 25 inscriptions preloaded on the device.

Graphics

Up to 24 graphic ads on the device.

Material specifications

Review the material specifications including the minimum and maximum envelope sizes, envelope stack height, and tape size details.

Envelope Size

- Minimum: 76 x 120 mm
- Maximum: 330 x 381 mm

Envelope Flap Depth

- 72.2 mm

Envelope Thickness

- Minimum: 0.20 mm
- Maximum: 8 mm

Stack Height for Mail

- 76.2 mm – This is the height of the inner edge of the side guide

Envelope Weight

- Minimum: 1 g
- Maximum: 450 g

Tape Size

- Minimum: 44.2 x 100 mm
- Maximum: 44.7 x 200 mm

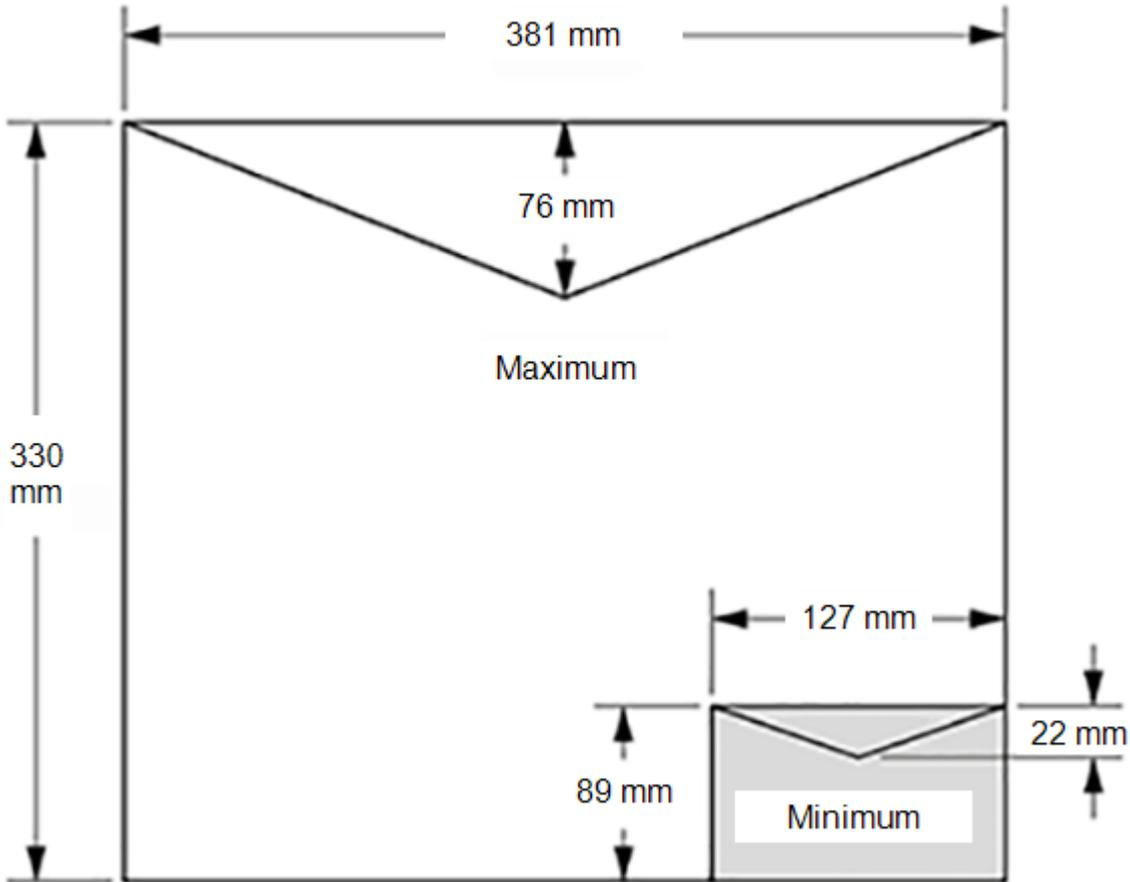

For a proper seal, the envelope's minimum flap angle must meet the following criteria:

- For envelopes with a flap length from 25-60 mm, the minimum flap angle is 18 degrees.
- For envelopes with a flap length greater than 60 mm to the maximum flap length for the particular model, the minimum flap angle is 21 degrees.

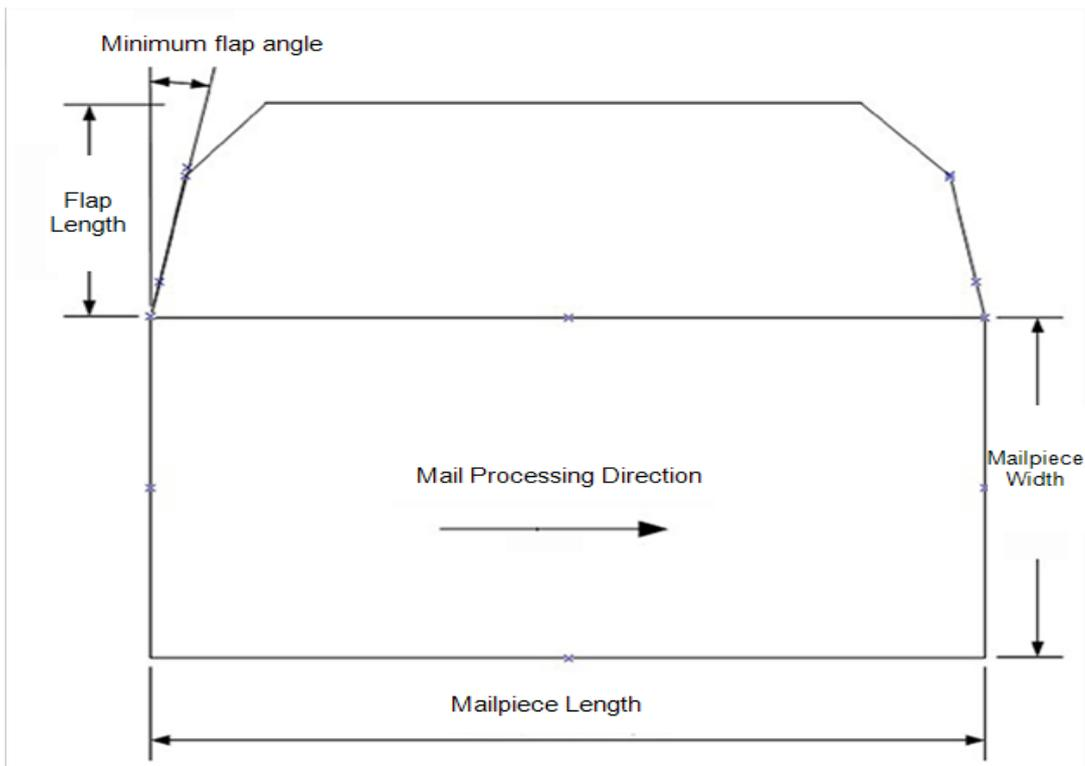

Lithium ion battery

This product contains a lithium ion battery. The battery must be recycled or disposed of properly. If you are leasing this product, you must return it to Pitney Bowes. Alternatively, contact your local waste disposal or recycle facility for instructions on how to dispose of it properly.

Agency compliance information

Agency Compliance Information can be found in the product's user guide. The user guide is available for download at:

- Australia - <http://www.pitneybowes.com/au/support>
- New Zealand - <http://www.pitneybowes.com/nz/support>

Important safety notes

Follow the normal safety precautions for all office equipment.

- Please read all instructions before you attempt to operate the system. Save these instructions for future use.
- Use only Pitney Bowes-approved supplies, in particular aerosol dusters. Improper storage and use of aerosol dusters or flammable aerosol dusters can cause an explosive-like condition that could result in personal injury and/or property damage. Never use aerosol dusters labeled flammable and always read instructions and safety precautions on the duster label.
- Use only the AC Power cord and AC Power adapter with the optional Thermal label printer supplied with your machine and plug it into a properly grounded wall outlet that's located near the printer and easily accessible. Failure to properly ground the power adapter can result in severe personal injury and/or fire.
- The power cord wall plug is the primary means of disconnecting the machine from the AC supply. The unit is on whenever it is plugged into a live receptacle, even though the operator display may be blank.
- To obtain supplies, please contact our Supply Line™ to place orders.
- Material Safety Data Sheets can be obtained through the web or from our Supply Line™. Refer to the Contact Information List for more information.
- Avoid touching moving parts or materials while the machine is in use. Keep hands, loose clothing, jewellery and long hair away from all moving parts.
- Do not remove covers or defeat safety interlock switches. Covers enclose hazardous parts that should only be accessed by properly trained service personnel. Immediately report to service any damaged or non-functioning components that renders the unit unsafe.

- Place the unit in an accessible location to allow for proper venting of the equipment and to facilitate servicing.
- Do not use an adapter plug on the line cord or wall outlet.
- Do not remove the ground pin from the line cord.
- Place the printer so the AC power adapter is close to an easily accessible wall outlet. DO NOT use a wall outlet controlled by a wall switch or one that is shared with other equipment.
- DO NOT route the power cord over sharp edges or trap it between pieces of furniture. Make sure there is no strain on the power cord.
- DO NOT route the DC power cord that plugs into the printer over sharp edges or trap it between pieces of furniture. Make sure there is no strain on the DC power cord.
- Make sure the area in front of the wall outlet into which the AC adapter is plugged is free from obstruction.
- To reduce the risk of fire or electrical shock, DO NOT attempt to remove covers or disassemble the control panel or its base. The cabinet encloses hazardous parts. If you should drop or otherwise damage the unit, call Pitney Bowes.
- Before clearing a stoppage, be sure machine mechanisms come to a stop.
- When removing stalled material, avoid using too much force to protect against minor personal injury and damaging equipment.
- To prevent overheating, do not cover any vent openings.
- Operation of this equipment without periodic maintenance will inhibit optimum operating performance and could cause the equipment to malfunction. Contact your machine supplier for required service schedule.
- Read all instructions before attempting to operate the equipment.
- Use this equipment only for its intended purpose.
- Always follow the specific occupational safety and health standards for your workplace.
- Use only Pitney Bowes approved direct thermal label media.
- Always follow the specific occupational safety and health standards prescribed for your workplace.

**Caution:**

In case of an ink spill, leaking ink or excessive ink accumulation, immediately disconnect the power cord from the wall plug and contact Pitney Bowes. Customer Service Representatives are available Monday through Friday, 8:30 am - 5:00 pm.

It is certified that the system complies with all applicable Directives of the European Union.

For a formal Declaration of Conformity please contact Compliance Engineering. Contact information is given in this guide or on a separate document supplied with your system.

Scale Safety

Precautions



Caution:

This equipment is intended to be used with limited power circuits with SELV and Non-hazardous energy outputs.

- The scale is not legal for trade
- Do not exceed the scale's maximum weight limit
- Do not place lighted candles, cigarettes, cigars, etc., on the scale.
- Use the equipment only for its intended purpose.
- Use only 9-volt Alkaline battery if needed
- Remove battery if scale is not going to be used for long periods of time or if the scale is powered through the USB cable.
- Dispose of old batteries properly.

Contacting Pitney Bowes

Your system information

Be sure to have the following information available before contacting Pitney Bowes Technical Support:

- **Product Name:** SendPro C Lite, SendPro C device
- **PCN and serial number:** check the label under the front cover of the machine.
- **Problem Description:**
 - What is happening and when
 - Are there any error messages?
- **Attempts to fix:**
 - What steps have you already tried to fix the problem?
 - If you tried, what happened?

Technical and Account Support:

Visit our website at (copy the URL and paste it into a browser):

<https://www.pitneybowes.com/nz/support.html>

Pitney Bowes Supplies

Visit our website at (copy the URL and paste it into a browser):

<https://www.pitneybowesdirect.co.nz/>

Note: Customer service representatives are available 8.30 am to 5 pm, Mon-Fri excluding public holidays.

Third party software

Third party software may have been incorporated into this product by Pitney Bowes Inc. (“PBI”) under permission from PBI’s licensors. Any special terms and conditions that apply to such software are provided below:

This product contains the following software:

- Okhttp3 which is licensed under the Apache License, Version number 2.0. The license can be downloaded from: <http://www.apache.org/licenses/LICENSE-2.0.html>. The source code for this software is available from <http://square.github.io/okhttp/>.
- Retrofit which is licensed under the Apache License, Version number 2.0. The license can be downloaded from: <http://www.apache.org/licenses/LICENSE-2.0.html>. The source code for this software is available from <https://square.github.io/retrofit/>.
- Okio which is licensed under the Apache License, Version number 2.0. The license can be downloaded from: <https://github.com/square/okio/blob/master/LICENSE.txt>. The source code for this software is available from <https://github.com/square/okio> .
- Commons-codec which is licensed under the Apache License, Version number 2.0. The license can be downloaded from: <http://www.apache.org/licenses/LICENSE-2.0.html>. The source code for this software is available from https://commons.apache.org/proper/commons-codec/download_codec.cgi.
- Commons-io which is licensed under the Apache License, Version number 2.0. The license can be downloaded from: <http://www.apache.org/licenses/LICENSE-2.0.html>. The source code for this software is available from https://commons.apache.org/proper/commons-io/download_io.cgi.
- Org.greenrobot:eventbus which is licensed under the Apache License, Version number 2.0. The license can be downloaded from: <http://www.apache.org/licenses/LICENSE-2.0.html>. The source code for this software is available from <http://greenrobot.org>.

- Org.greenrobot:greendao which is licensed under the Apache License, Version number 2.0. The license can be downloaded from: <http://www.apache.org/licenses/LICENSE-2.0.html>. The source code for this software is available from <http://greenrobot.org/greendao>.
- FasterXml.jackson.core:jackson-core which is licensed under the Apache License, Version number 2.0. The license can be downloaded from: <http://wiki.fasterxml.com/JacksonLicensing>. The source code for this software is available from <http://wiki.fasterxml.com>.
- Aws-android-sdk-core which is licensed under the Apache License, Version number 2.0. The license can be downloaded from: <https://github.com/aws/aws-sdk-android/blob/master/LICENSE.APACHE.txt>. The source code for this software is available from <https://github.com/aws/aws-sdk-android>.
- Aws-android-sdk-iot which is licensed under the Apache License, Version number 2.0. The license can be downloaded from: <https://github.com/aws/aws-sdk-android/blob/master/LICENSE.APACHE.txt>. The source code for this software is available from <https://github.com/aws/aws-sdk-android>.
- Aws-android-sdk-s3 which is licensed under the Apache License, Version number 2.0. The license can be downloaded from: <https://github.com/aws/aws-sdk-android/blob/master/LICENSE.APACHE.txt>. The source code for this software is available from <https://github.com/aws/aws-sdk-android>.
- Nv-websocket-client which is licensed under the Apache License, Version number 2.0. The license can be downloaded from: <http://www.apache.org/licenses/LICENSE-2.0.html>. The source code for this software is available from <https://github.com/TakahikoKawasaki/nv-websocket-client>.
- bumptech.glide which is licensed under the Apache License, Version number 2.0. The license can be downloaded from: <http://www.apache.org/licenses/LICENSE-2.0.html>. The source code for this software is available from <https://github.com/bumptech/glide>.
- Jakewharton:butterknife which is licensed under the Apache License, Version number 2.0. The license can be downloaded from: <http://www.apache.org/licenses/LICENSE-2.0.html>. The source code for this software is available from <https://github.com/JakeWharton/butterknife>.
- Caverock:androidsvg which is licensed under the Apache License, Version number 2.0. The license can be downloaded from: <http://www.apache.org/licenses/LICENSE-2.0.html>. The source code for this software is available from <https://mavenrepository.com/artifact/com.caverock/androidsvg/1.2.1>.
- Glassfish:javafx.annotation which is dual licensed under the CDDL, Version 1.0, and the GNU General Public License, Version 2, June 1991, with the Classpath Exception. The licenses can be downloaded from: <https://javaee.github.io/glassfish/LICENSE>. The source code for this software is available from <https://javaee.github.io/glassfish>.
- CalligraphyXamarin which is licensed under the Apache License, Version number 2.0. The license can be downloaded from: <http://www.apache.org/licenses/LICENSE-2.0.html>. The source code for this software is available from <https://github.com/mikescandy/Calligraphy-xamarin>.
- Newtonsoft.JSON.NET which is licensed under the MIT License. The license can be downloaded from: <https://github.com/JamesNK/Newtonsoft.Json>. The source code for this software is available from <https://github.com/JamesNK/Newtonsoft.Json>.

- MaterialChips which is licensed under the Apache License, Version number 2.0. The license can be downloaded from: <http://www.apache.org/licenses/LICENSE-2.0.html>. The source code for this software is available from <https://github.com/DoodleScheduling/android-material-chips>.
- Android Open Source Project (“AOSP”), which is licensed under the Apache License, Version number 2.0. The license can be downloaded from: <http://www.apache.org/licenses/LICENSE-2.0.html>. AOSP also contains the Linux kernel which is licensed under GNU General Public License, Version 2, June 1991 (“GPL”). The license can be downloaded from: <http://www.gnu.org/licenses/gpl-2.0.html> Copyright © 1989, 1991 Free Software Foundation. For up to three years from PBI’s distribution of this product, you may obtain a complete machine-readable copy of the source code for the Linux kernel under the terms of the GPL, without charge except for the cost of the media, shipping, and handling, upon written request to PBI. Such requests should be sent by e-mail to iptl@pb.com.
- This product contains Paho.mqtt.java, which is licensed under the Eclipse Public License - v 2.0 and the Eclipse Distribution License - v 1.0. The licenses can be downloaded from <https://www.eclipse.org/legal/epl-2.0/> and <https://www.eclipse.org/org/documents/edl-v10.php>, respectively. The modified source code can be downloaded from: <https://github.com/PitneyBowes>.



3001 Summer Street
Stamford, Connecticut 06926
www.pitneybowes.com

PB Form SV63242-nz Rev.B
© Pitney Bowes Limited, 2022
We have made every reasonable effort to assure the accuracy and usefulness of this guide, however we cannot assume responsibility for errors or omissions or liability for the misuse or misapplication of our products.