



Shipping & Mailing
Postage Meters

SendPro® C Lite, SendPro® C, SendPro®+

PCN 8H00

Operator Guide

US Weights and Measures Edition
SV63421 Rev. A
December 06, 2024

©2024 Pitney Bowes Inc.

All rights reserved. This book may not be reproduced in whole or in part in any fashion or stored in a retrieval system of any type or transmitted by any means, electronically or mechanically, without the express written permission of Pitney Bowes.

The use of this information by the recipient or others for purposes other than the training of customers on Pitney Bowes equipment may constitute an infringement of intellectual property rights of Pitney Bowes, and Pitney Bowes assumes no responsibility for any such use of the information.

We have made every reasonable effort to ensure the accuracy and usefulness of this manual. However, we cannot assume responsibility for errors or omissions or liability for the misuse or misapplication of our products.

Except as provided in writing, duly signed by an officer of Pitney Bowes, no license either express or implied, under any Pitney Bowes or third party's patent, copyright or other intellectual property rights is granted by providing this information.

PB Postage™ is a trademark of Pitney Bowes Inc.

Table of Contents

1 - Quick start guide

Finding the Product Code Number (PCN) and serial number	9
Navigating the Home screen	10
Adding a Print on Envelopes account	12
Navigating the Print on Envelopes app	13
Preventing envelope feeding problems	14
Sending a First-Class Mail envelope	15
Sending a large First-Class® envelope	15
Sending Certified Mail	17
Sending an international letter	17
Sending mail using a Certificate of Mailing	18
Using USPS special services	19
Updating postal rates or software for printing on envelopes	20
Adding or refilling postage for printing on envelopes	21
Sealing envelopes when you print postage	22
Filling the moistener tank	23
Replacing the ink cartridge	24
Printing a test pattern	26
Adding favorite apps	27
Creating presets for printing postage	28
Selecting a preset for printing postage	29

2 - Connectivity information

Setting up a wired network connection	32
Setting up a wireless (Wi-Fi) network connection	35
Connecting to a hidden Wi-Fi network	35
Forgetting a Wi-Fi network	37
Checking your network connection	39

Finding the MAC address for wired and wireless networks	39
Setting up a Proxy server	43

3 - Managing your Device

Creating or disabling the security PIN	48
Resetting a forgotten security PIN	49
Adjusting time zone and scale location code	49
Adjusting display brightness	50
Adding favorite apps	50
Setting up the Energy Saver	51
Setting up the Screen Saver	52
Using USPS Informed Delivery	52
Uploading system logs	53

4 - Printing on envelopes

Navigating the Print on Envelopes app	56
Checking the available funds for printing postage	57
Adding or refilling postage for printing on envelopes	59
Sending a First-Class Mail envelope	60
Sending a large First-Class® envelope	61
Sending Certified Mail	62
Sending an international letter	63
Sending mail using a Certificate of Mailing	63
Advancing the date	65
Printing postage without a date for pre-printed mailpieces	65
Printing additional postage	66
Re-dating your mail	67
Using USPS special services	68
Using the scale when printing postage	68
Sealing envelopes when you print postage	70
Sealing envelopes without printing postage	71
Zeroing the scale	72
Adding insurance to your mail	73

Printing a custom or standard graphic	74
Sending mail using Electronic Return Receipt (ERR)	77
Getting a USPS refund for damaged or incorrectly printed mail	78
Creating a custom text message for your mail	79
Adding a custom text message to your envelope or tape	81
Editing or deleting a custom text message	83
Printing a graphic without printing postage	85
Adding an inscription	86
Printing only the date and time	86
Setting the right margin adjustment	88

5 - Managing Printing on Envelopes

Confirming your meter update	90
Changing the default refill amount for printing postage	90
Uploading postage transactions	91
Clearing or resetting the number of mailpieces sent	92
Updating postal rates or software for printing on envelopes	92
Confirm the effective date for postal rates	93
Setting the low funds warning for printing postage	94
Setting up a mailer ID	94
Updating the ZIP code	94
What is Accounting	95
Turning Print on Envelopes account passwords on or off for printing postage	96
Adding a Print on Envelopes account	97
Editing an account	98
Making an account inactive	98
Deleting an account	99
Creating presets for printing postage	99
Viewing presets for printing postage	100
Selecting a preset for printing postage	101
Modifying presets for printing postage	101
Setting the default preset timer	101

6 - View and Print Reports

Viewing a receipt when refilling postage	104
Viewing the total spent on printing postage	104
Viewing the refill history for printing postage	104
Printing a funds report	104
Running account reports	105
Emailing an account report	106
Setting the report period for an account	107
Setting the account report preferences	108
Printing a scale report	109

7 - Maintenance

Checking the postage print quality	112
Printing a test pattern	112
Checking the ink level	113
Replacing the ink cartridge	114
Changing the ink waste pad	116
Cleaning the printhead	118
Installing the printhead	123
Cleaning the moistener brush and wick assembly	128
Filling the moistener tank	132
Avoiding envelope sealing issues	133
Preventing envelope feeding problems	134
Moving the SendPro C Lite, SendPro C, SendPro+	135

8 - Supplies

Ordering supplies	138
-------------------------	-----

9 - Device Information

USPS requirements	140
Key in Postage	140

Sections of the meter impression	140
Finding the SendPro application software version	141
Postal Security Device	142
Parts of the SendPro C Lite, SendPro C, SendPro+	142
Connections on the back	143
Specifications	144
Material specifications	147

10 - Contacting Pitney Bowes

Contacting Pitney Bowes	152
-------------------------------	-----

11 - Safety

Lithium Ion Battery	155
Agency Compliance Information	155
Important Safety Notes	155
Note for California Customers Only on all Models	157

12 - Third party software

Third party software	159
----------------------------	-----

1 - Quick start guide

In this section

Finding the Product Code Number (PCN) and serial number.....	9
Navigating the Home screen.....	10
Adding a Print on Envelopes account.....	12
Navigating the Print on Envelopes app.....	13
Preventing envelope feeding problems.....	14
Sending a First-Class Mail envelope.....	15
Sending a large First-Class® envelope.....	15
Sending Certified Mail.....	17
Sending an international letter.....	17
Sending mail using a Certificate of Mailing.....	18
Using USPS special services.....	19
Updating postal rates or software for printing on envelopes.....	20
Adding or refilling postage for printing on envelopes.....	21
Sealing envelopes when you print postage.....	22
Filling the moistener tank.....	23
Replacing the ink cartridge.....	24
Printing a test pattern.....	26
Adding favorite apps.....	27
Creating presets for printing postage.....	28
Selecting a preset for printing postage.....	29

Finding the Product Code Number (PCN) and serial number

In order to find the correct information for your device, you need to know the model number.

To locate the **(1) Product Code Number (PCN)** and the **(2) 7-digit serial number**, check the label on the rear of the device or under the display cover. The serial number appears as zeros here for security reasons.

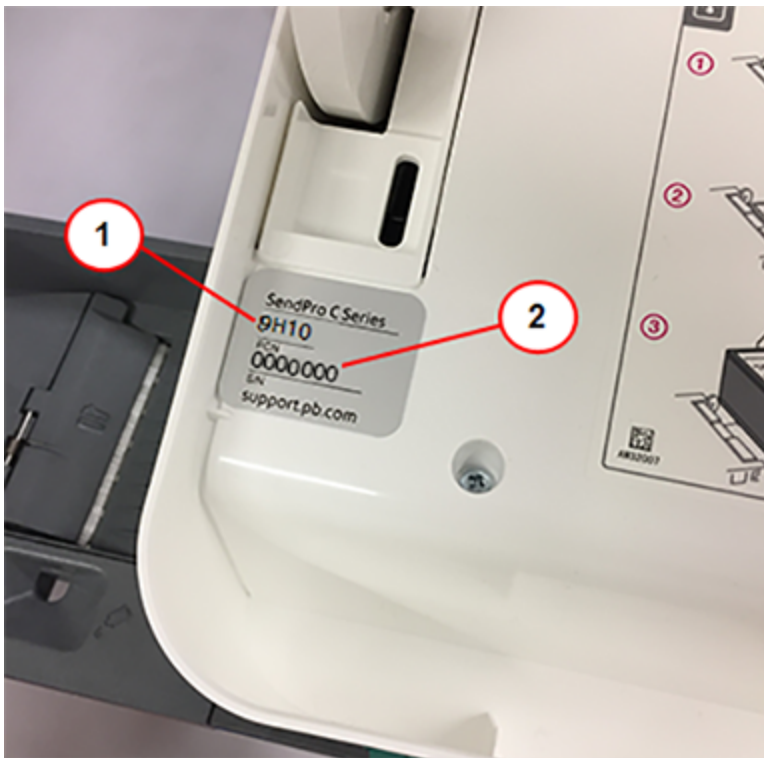

Navigating the Home screen

You can print postage from the Home screen on the SendPro C Lite, SendPro C, SendPro+.

Printing on envelopes

Tap **Print on Envelopes** to print postage for envelopes and post cards.

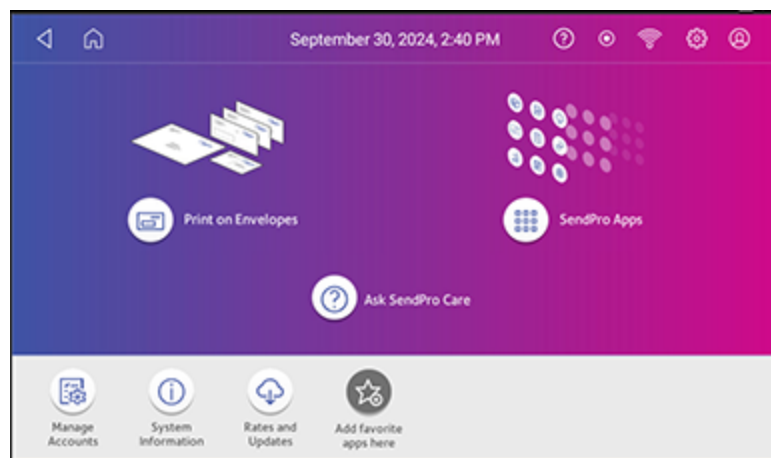

Using SendPro Apps

Tap on **SendPro Apps** to access a variety of apps to support and enhance your device.

For example, you can:

- Check for rates and updates (Rates and Updates)
- Check the status of your network connection (Network Connection).

You can also add your most frequently used apps to a list of favorites appearing along the bottom of the Home screen.

Getting help on your device

Tap **SendPro Care** on the Home screen to get information about your device

The SendPro Care app automatically recognizes your device issues and provides recommendations for resolving them. The app also provides:

- Real-time predictive updates, diagnostic, error notifications, and offers.
- Solutions to resolve the issue.
- Essential tools and guides.
- Voice (mobile app) and text search to resolve issues quickly.
- Product health management and tracking.
- Account balances and case status.
- Spending and saving insights to track your budget more effectively.

To learn how to use the SendPro Care app, tap **i How to use** on the main page of the app.

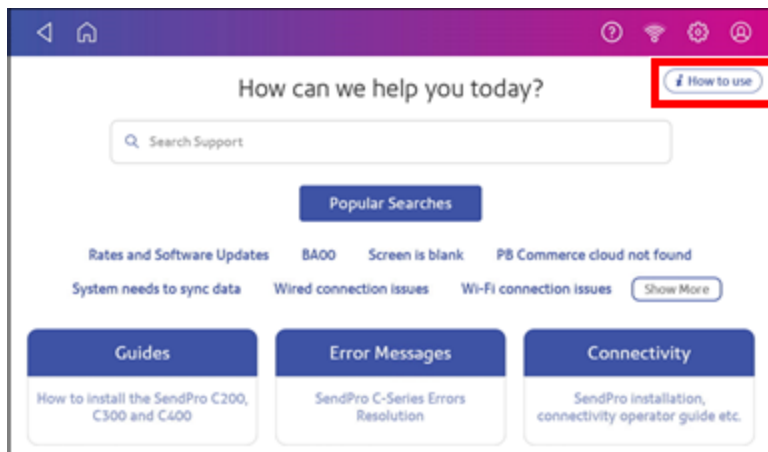

The toolbar

The toolbar appears at the top of every screen. It allows you to view and change settings for your device.



1. Back - Return to the previous screen.
2. Home - Return to the Home screen from anywhere in Print on Envelopes. Tap the question mark in the toolbar to open the SendPro Care app.
3. Network - View the current network type (wireless or Ethernet) and status and strength (for wireless connection). Allows you to turn wireless connection on or off. The icon here represents a wireless connection.
4. Settings - View or change your device and app settings. This includes adjusting the screen brightness, setting sound notification levels, and viewing wireless or Ethernet connection information. For Print on Envelopes, this includes setting the default postage refill amount, installing external scales and performing maintenance.
5. Profile - View your profile, log out, or lock your SendPro C Lite, SendPro C, SendPro+.

Adding a Print on Envelopes account

You can add a Print on Envelopes account to track your costs for printing postage on envelopes. This is different from your PB account which is used to fund your postage.

Accounting is a feature that is optional and needs enabling if you want to use it. Contact your Pitney Bowes Sales Representative for information about options and pricing.

1. Tap **SendPro Apps** on the Home screen.
2. Tap **Manage Accounts**.
3. Tap **Create new account**.
4. Tap **Create a new account** for a new account.
5. Enter the account name in the Enter account name field. Account names can be up to 75 characters long.
If the keyboard does not pop up, tap the line in the gray box.
6. Enter a unique code in the Code field to identify each account. Codes can be alphanumeric. Codes help you locate accounts more easily.
7. You can use the optional fields, such as:
 - **Description** - Enter a description of the account up to 150 characters.
 - **Password** - Tap **Password** to add a password for an account.
 - Passwords are case sensitive, can be alphanumeric, and must be four characters in length. If you do set a password, you need to enter it to print mail.
8. Ensure you set the status to active.
9. Tap anywhere on the screen outside of the fields when complete.

10. Tap **OK** to save. The name of the new account appears.
 - Tap **Create New Account** to create another account.
 - Tap **Add a Sub Account to this account** to add a sub account to the account you just created.
 - Tap **Done** if you do not need to create any more accounts.
11. Press the **back arrow** to return to the account list.

Navigating the Print on Envelopes app

The Print on Envelopes app is the starting point for printing postage on an envelope or a tape. It also allows you to change what you print.

To open the Print on Envelopes app, tap **Print on Envelopes**.

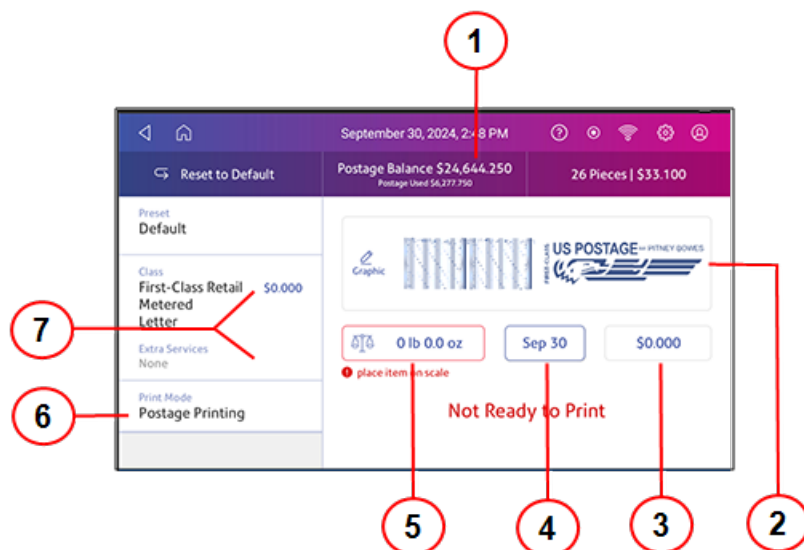

On this screen, you can:

1. View **Postage Balance** - View the balance of funds you have left in your device.
2. Preview or add **Graphic** - Tap **Graphic** to preview or add graphics.
3. View **Total postage amount** - View the total postage amount.
4. View **Date** - Tap the date to view the date options.
5. View **Weight** - You must use the attached scale for weighing mail. Tap **Weight** to zero the scale.

6. View **Print Mode** - View the available printing modes such as printing a graphic only, printing the date and time, or seal envelopes without printing postage.
7. View **Class** - Tap **Class** to view available postal classes and any extra services.
8. View **Account** - Tap **Account** to charge back postage to departments or clients. Run reports showing how you spent your postage over specific time periods. If you did not purchase Accounting, you will not see the Accounting option.

Preventing envelope feeding problems

Ensure you feed envelopes correctly to help prevent feeding problems.

Feeding mail

1. For your first envelope, hold the far edge of the envelope against the back wall of the feeder.
2. Slide the envelope into the feeder until you feel it touch the rollers. You hear the motor begin. Do not release the envelope until the feeder grabs it to pull it through the device.
3. You hear the motor continue to run for about 5 seconds once it prints postage on the envelope.
4. Continue to feed envelopes one at a time. Make sure you press the edge of each envelope against the back wall of the feeder and into the feeder until it touches the rollers.
 - Make sure the envelopes fully exit the feeder and do not pile up on the edge of the feeder.
 - If you are using a stacker, you may need to extend the stacker tray so that the envelopes exit the feeder completely.

Hold the envelope against the back wall to avoid skews

If you do not hold the envelope against the back wall, it can feed in crooked or skewed. A skewed envelope can either exit the device with no postage applied or cause a jam. The message Clear Paper Jam appears. This could deduct funds. Even a minor skew that may be difficult to see can cause a jam.

Preventive action

To prevent envelope feeding problems:

- Using a can of non-flammable compressed air, blow on the feed deck on the left side and work toward the transport deck on the right side. Make sure to remove all the dust and debris.

Sending a First-Class Mail envelope

First-Class Mail is an economical way to send mailpieces through the USPS. You can send standard postcards, letters, and large envelopes and small packages up to 15.99 ounces.

1. Tap **Print on Envelopes** on the Home screen.
2. If you have the accounting feature enabled, tap **Account** and select an account.
3. Tap **Class**.
4. Tap **Start Over** to show a list of all the available classes.
5. Tap **First-Class Retail Metered** for a First-Class Mail envelope.
6. Tap **Letter**.
7. Select any special services you wish to use.
8. Tap **Apply**.
9. Place the envelope on the scale. The weight appears.
10. Place the envelope or envelopes on the feed deck. Depending on the SendPro C model you have, feed the envelopes manually or tap **Start** to feed the envelopes.

Important: Your device will upload transactions if you have previously printed any mail. Once the upload completes, you see the message "Transaction upload status, Upload success" with a check mark. Tap the check mark.

Sending a large First-Class® envelope

Before you select a rate for a large envelope, you need to determine whether the mailpiece you are sending is a letter or large envelope according to the USPS.

If your mailpiece weighs more than 3.5 oz, the device automatically sets the class to Large Envelope regardless of the dimensions. If the mailpiece weighs less than 3.5 oz but has the dimensions of a large envelope, you need to manually select Large Envelope when you choose the class.

Weigh the mailpiece and measure the dimensions

1. Tap **Print on Envelopes** on the Home screen.
2. If you have the accounting feature enabled, tap **Account** and select an account.

3. Place the mailpiece on the scale. The weight appears.

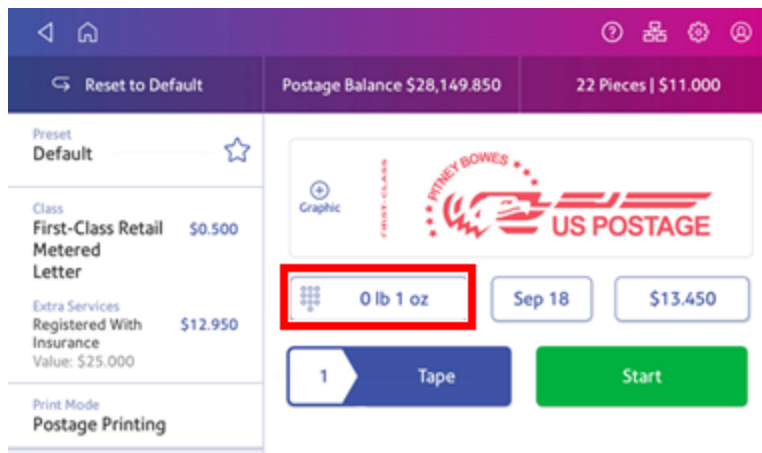

4. Measure and record the dimensions of the mailpiece.
5. Tap **Home** to return to the Home screen.

If the mailpiece is less than 3.5 oz, but has the dimensions of a large envelope:

1. Tap **Home**.
2. Tap **Print on Envelopes**.
3. If you have the accounting feature enabled, tap **Account** and select an account.
4. Tap **Class**.
5. Tap **Start Over** to show a list of all the available classes.
6. Tap **First-Class Retail Metered** for a First-Class mail envelope.
7. Tap **Large Envelope**.
8. Select special services, if required.
9. Tap **Apply**.
10. Place the envelope or envelopes on the feed deck. Depending on the SendPro C model you have, feed the envelopes manually or tap **Start** to feed the envelopes.
If the envelope is too thick to go through the feeder, print the postage on a tape and apply the tape to the large envelope or flat.

Sending Certified Mail

Certified Mail is a USPS service that provides you with proof of mailing by sending you a receipt once your mailpiece arrives at its destination.

Not all extra services like Certified Mail are available for all classes and you can only combine certain services.

1. Tap **Print on Envelopes** on the Home screen.
2. If you have the accounting feature enabled, tap **Account** and select an account.
3. Tap **Class**.
4. Tap **Start Over** to show a list of the available classes.
5. Tap a class that you can combine with Certified Mail (for example, First Class or Priority Mail).
6. Tap the mailpiece type (for example, letter or large envelope).
7. Select **Certified** and tap **Apply**.
8. Depending on the type class and type of mailpiece, enter the destination ZIP Code and tap **Apply**.
9. Place the envelope or envelopes on the feed deck. Depending on the SendPro C model you have, feed the envelopes manually or tap **Start** to feed the envelopes.
10. Place the green Certified Mail label (USPS Label 3800) on the mailpiece.

Sending an international letter

Use this process if you need to send mail from the United States to a different country.

1. Tap **Print on Envelopes** on the Home screen.
2. If you have the accounting feature enabled, tap **Account** and select an account.
3. Tap **Class**.
4. Tap **Start Over** to display a list of all the available classes.
5. Tap **First-Class Mail Intl Retail** for a First-Class Mail envelope.
6. Tap **Letter**.
7. Tap in the **Country** field and use the keypad to enter the destination country.
8. Select special services, if required.
9. Tap **Apply**.
10. Place the envelope on the scale. The weight appears.
11. Place the envelope or envelopes on the feed deck. Depending on the SendPro C model you have, feed the envelopes manually or tap **Start** to feed the envelopes.

Important: Your device will upload transactions if you have previously printed any mail. Once the upload completes, you see the message "Transaction upload status, Upload success" with a check mark. Tap the check mark.

Sending mail using a Certificate of Mailing

Purchase a Certificate of Mailing when you need to have proof that you sent a letter or package.

You can only obtain a Certificate of Mailing from the USPS. A Certificate of Mailing is a receipt that provides evidence of the date that you took your mail to the USPS for mailing. You cannot produce this certificate with your device. It is a record of when you turned the mailpiece over to the Post Office and you can only get it from the USPS.

1. Fill out the USPS postal forms [3606-D](#), [3665](#), or [3817](#). Obtain these at the Post Office or online at the [USPS website](#).
2. Calculate the fees for all of the mailpieces. This can include the cost of the Certificate of Mailing fees as well as the total postage amount.
3. Tap **Print on Envelopes** on the Home screen.
4. If you have the accounting feature enabled, tap **Account** and select an account. If your device's model number is 8H00 or 9H00 and if you have only a single account, once you select that account the device will remember that account the next time you start Print on Envelopes.
5. Scroll down and tap **Print Mode** on the Print on Envelopes screen.
6. Tap **Certificate of Mailing**.

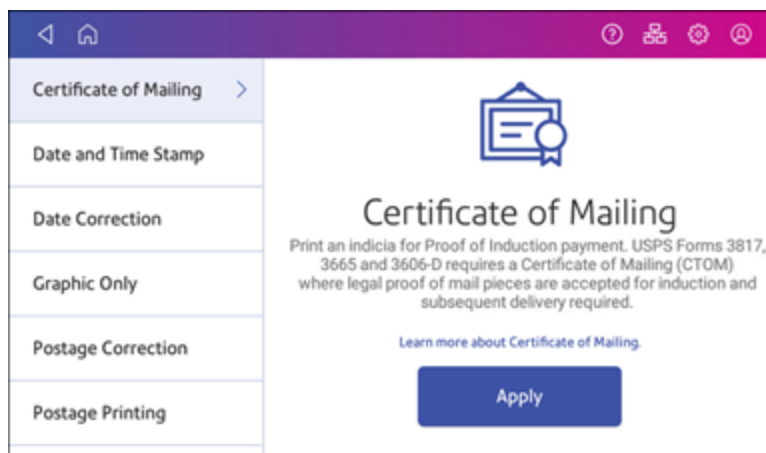

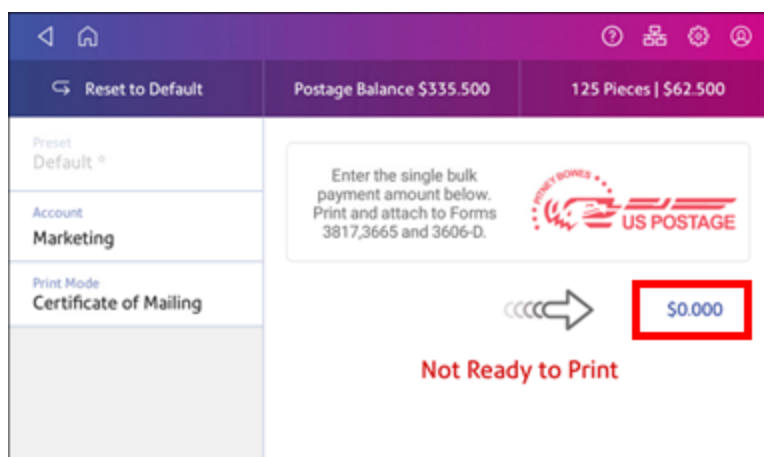
7. Tap **Apply**.

8. Tap on the postage amount and enter the amount you calculated in step 2.
9. Feed the appropriate form (3606-D, 3665, or 3817) through the feeder so that the device stamp prints on the form or on a tape strip that can be applied to the form. Alternatively, you can print the device stamp on each of the mailpieces included in the Certificate of Mailing.
10. Take the mailpieces and the printed form to the Post Office. They will apply a round stamp proof of induction mark that serves as legal proof that your items will enter the USPS.

Using USPS special services

You can select additional services for your mail. These include Certified Mail, Insured Mail, Delivery Confirmation, Registered Mail and more. The number and types of services available depend on the class of mail.

1. Tap **Print on Envelopes** on the Home screen.
2. Tap **Class**.
3. Tap **Start Over** to see a list of the available classes.
4. Tap the class you wish to use. Sub-classes appear when available for the selected class.
 - For some classes, you must select the type of mailpiece. For example, if you select First-Class Retail Metered, you must select either Letter, Large Envelope, or Package.
5. Select any special services you wish to use.
6. Enter a ZIP code if required.
7. For some classes, you need to either scan or manually enter the Electronic Certified barcode from your label. Then, attach your label to your envelope or package.
8. Tap **Apply**.

Updating postal rates or software for printing on envelopes

Automatic updates

Your device updates postal rates and software automatically.

Keep your device turned on and connected to your network to get your automatic updates, as the device downloads updates during the evening hours.

Manual postal rate updates

1. Select Rates and Updates:
 - Tap **SendPro Apps**, then **Rates and Updates**.
2. If new rates are available, your device downloads and installs updates.
 - a. If the rates are available today, this message appears:
"New postage rates took effect today. Your device has been updated and new rates are already in effect. To learn more, visit pitneybowes.com/ratesandupdates."
 - b. If the rates took effect already, this message appears:
"New postage rates took effect on [effective date]. Your device has been updated and new rates are already in effect. To learn more, visit pitneybowes.com/ratesandupdates."
 - c. If the new rates are pending, this message appears:
"New postage rates take effect on [future effective date]. Your device has been updated and you'll see the new rates then. To learn more, visit pitneybowes.com/ratesandupdates."
3. To continue tap **Got it**.

Manual software updates

1. Select Rates and Updates:
 - Tap **SendPro Apps**, then **Rates and Updates**.

2. If new rates are available, your device downloads and installs updates.
 - a. If the rates are available today, this message appears:
"New postage rates took effect today. Your device has been updated and new rates are already in effect. To learn more, visit pitneybowes.com/ratesandupdates."
 - b. If the rates took effect already, this message appears:
"New postage rates took effect on [effective date]. Your device has been updated and new rates are already in effect. To learn more, visit pitneybowes.com/ratesandupdates."
 - c. If the new rates are pending, this message appears:
"New postage rates take effect on [future effective date]. Your device has been updated and you'll see the new rates then. To learn more, visit pitneybowes.com/ratesandupdates."
3. To continue tap **Got it**.

Adding or refilling postage for printing on envelopes

Add or refill postage for your Print on Envelopes balance as soon as you receive a message that your funds are getting low.

Before you begin

Check that your device is connecting to the internet.

- For wired network connections, the following connection image appears in the toolbar:



- If you have a wireless connection, the following connection image appears in the toolbar:



Add postage for Printing on Envelopes

1. Tap **Print on Envelopes** on the Home screen.
2. Tap **Postage Balance**.
3. Tap **Refill Postage**.
4. Enter the amount of postage you wish to add.

5. Tap **Refill Mail Postage**.
6. Tap **View Receipt** to view or print a receipt.
7. Tap **Done**.
8. Your updated postage balance appears on the Print on Envelopes app.

Sealing envelopes when you print postage

You can seal envelopes and print postage at the same time with your SendPro C Lite, SendPro C, SendPro+.

1. Check the level of sealing solution in the moistener tank. Add more if required.
2. Tap **Print on Envelopes** on the Home screen.
3. Tap **Account** and select an account if accounting is enabled on your device.
4. Tap **Weight**.

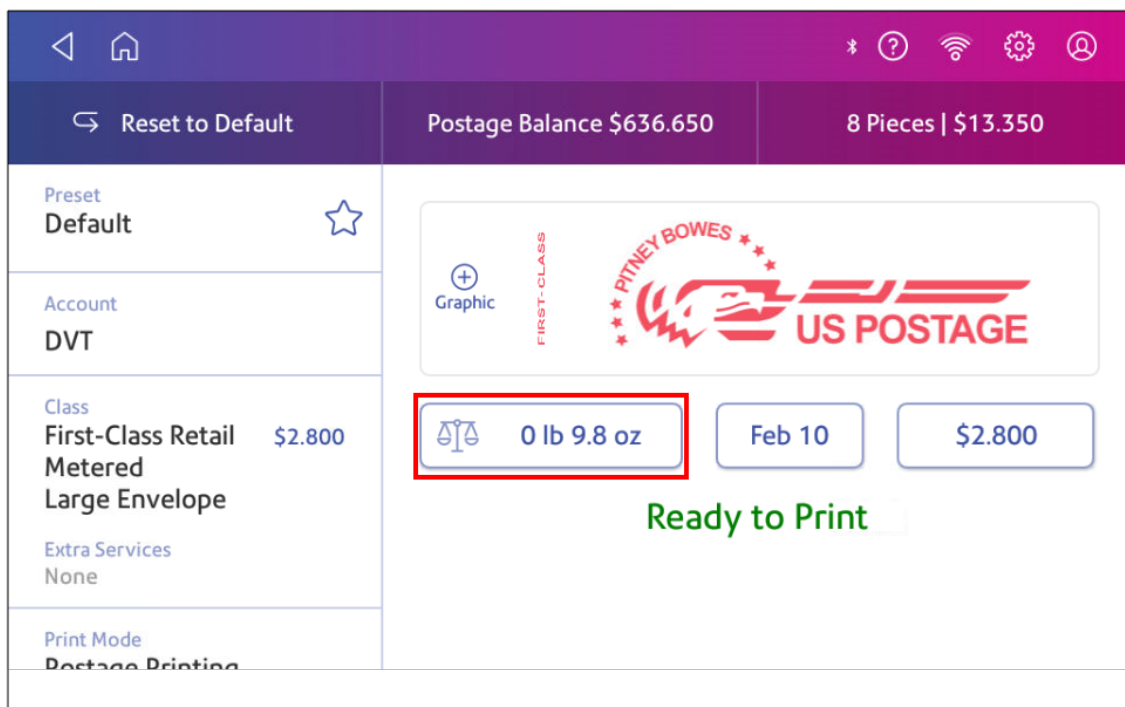

5. Tap **Scale**.
6. Place the envelope on the scale. You must do this before the next step or else **Apply** remains inactive.
7. Tap **Class** then select the class of mail you want.

8. Tap **Graphic** then select a graphic, if necessary.
9. Tap **Apply** to continue.
10. Slide the envelope flap under the edge of the feed deck so the moistener can wet the flap.



11. Insert the envelope into the device. The device prints the postage.

Important: If the moistener tank is full and your envelopes do not seal correctly, clean or replace the moistener brush and wick.

Filling the moistener tank

Your device will need refills of E-Z Seal® in order to seal envelopes. Follow these steps to fill the moistener tank.

1. Check the level of E-Z Seal® in your moistener tank (1).

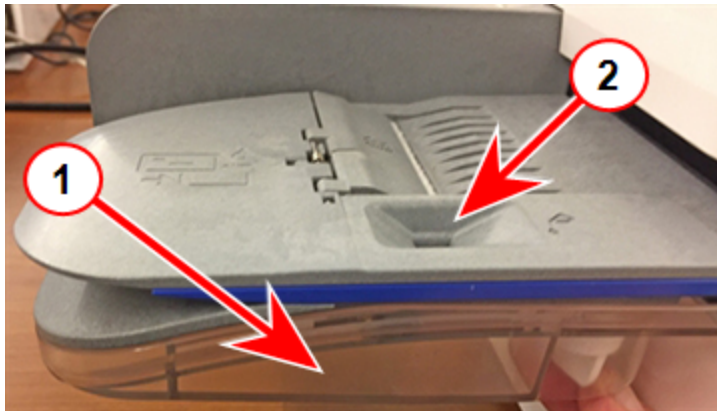

2. Add enough E-Z Seal® to bring the sealant level up to the bottom of the fill hole (2). Do not overfill the tank.
3. If the tank is empty, allow 30 minutes for the moistener brush and wick to get completely wet.

Replacing the ink cartridge

Replace the ink cartridge when the low ink warning appears. This ensures your device is in optimal working condition.

1. Tap **Settings**.



2. Scroll down and tap **Mail Printer Maintenance**.
3. Tap **Install Ink**.
4. Lift the top cover. The ink cartridge moves to the front position.

5. Remove the ink cartridge, as shown on the label next to the cartridge holder.

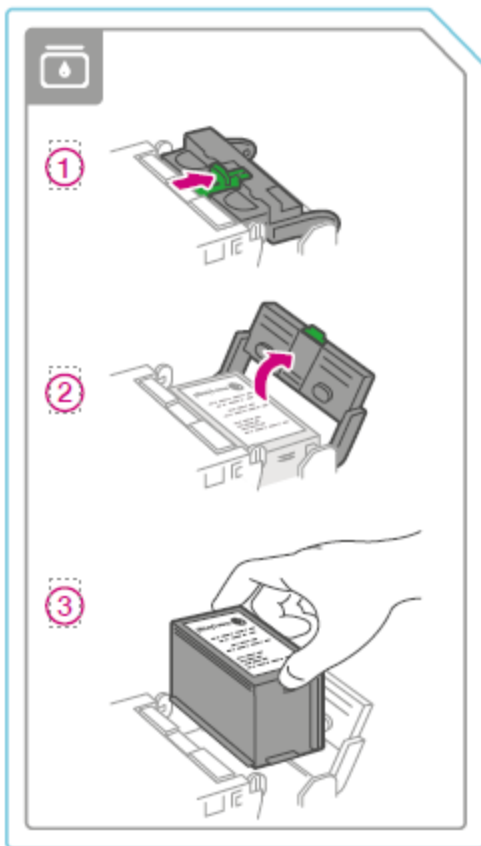

6. Insert the new ink cartridge, then close the ink cartridge guard.

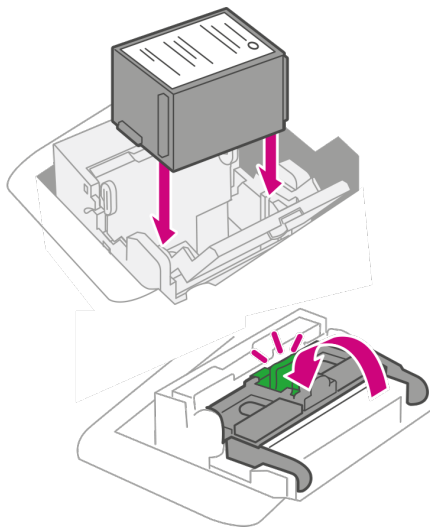

7. Close the top cover.

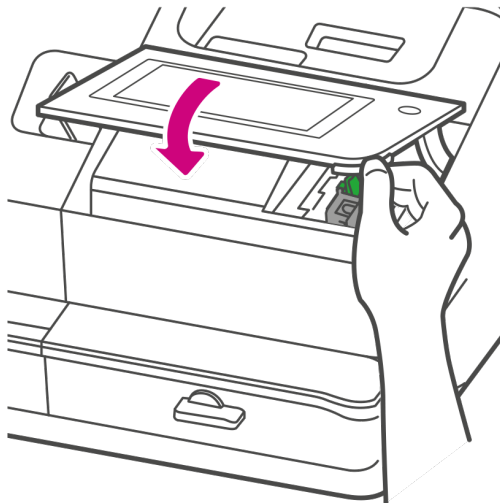

8. The cartridge repositions itself and the Mail Printer Maintenance screen appears.
9. Print a test pattern to ensure that your ink cartridge installs properly.

Printing a test pattern

Print a test pattern to see if the printhead is working properly or if you have enough ink in the cartridge.

1. Tap **Settings**.



2. Scroll down and tap **Mail Printer Maintenance**.
3. Tap **Print Test Pattern**.
4. Insert the envelope into the device when the message "Print a Test Pattern?" appears.

5. Examine the pattern printed on the envelope:
 - Tap **Done** if the lines are unbroken and match the "Good" test pattern shown on the display.
 - Tap **Clean Print Nozzle** if the test pattern has missing or incomplete lines
 - Once the cleaning operation completes, you must print another test pattern.
 - If this new pattern still has broken or missing lines, you may need to replace the ink cartridge or clean or replace the printhead.
 - If you see no improvement in print quality, do not repeat the cleaning, as cleaning the print nozzles consumes ink.

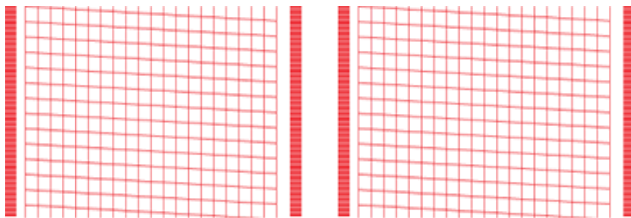

Good Test Pattern

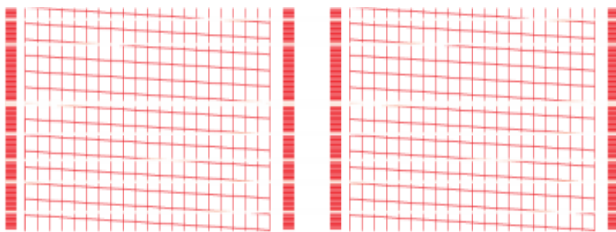

Bad Test Pattern

Adding favorite apps

Add your favorite apps to make them easy to find on the Home screen.

1. Tap **SendPro Apps** on the Home screen. All the available apps display.
2. Tap **Edit Favorites** and a star appears next to each app.

3. Tap the star next to an app to make it a favorite.

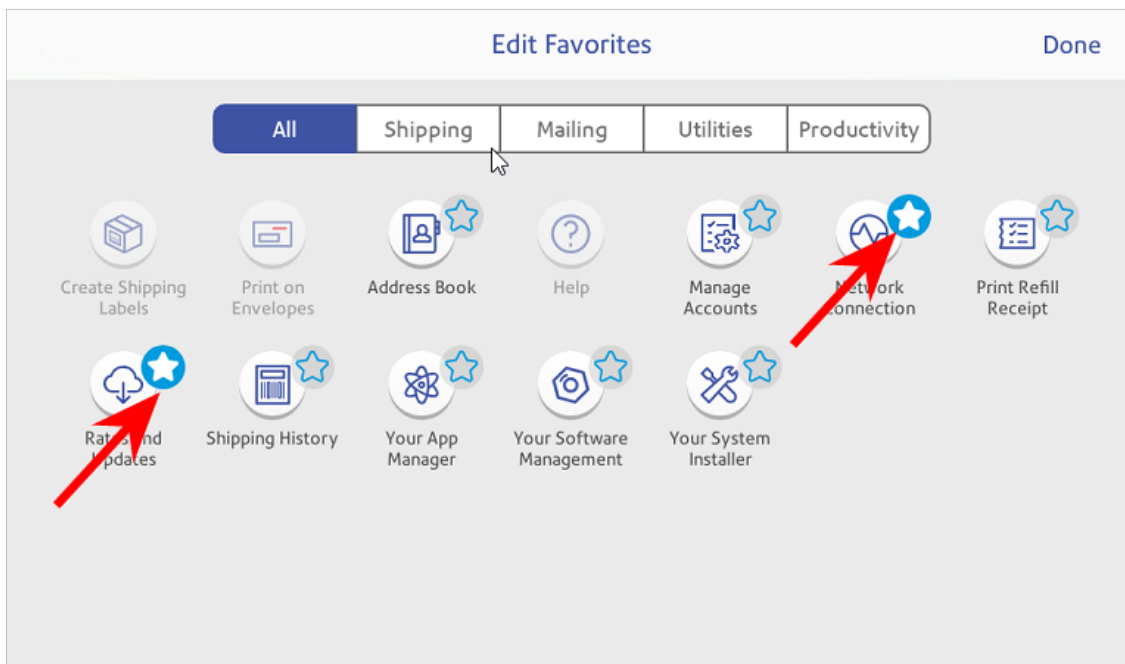

4. Tap **Done** when complete.

Creating presets for printing postage

Create presets to store a group of commonly-used settings. Presets can store settings such as a postage class, an account and a graphic. The maximum number of presets you can have is 21. This includes the default preset.

1. Tap **Print on Envelopes** on the Home screen.
2. Tap **Class**, select the class and any special services, messages or graphics.
3. Verify the settings in the Print on Envelopes app.

4. Tap the **star** in the Preset box.

Important: You must modify something in the Print on Envelopes app for the Preset star to appear.

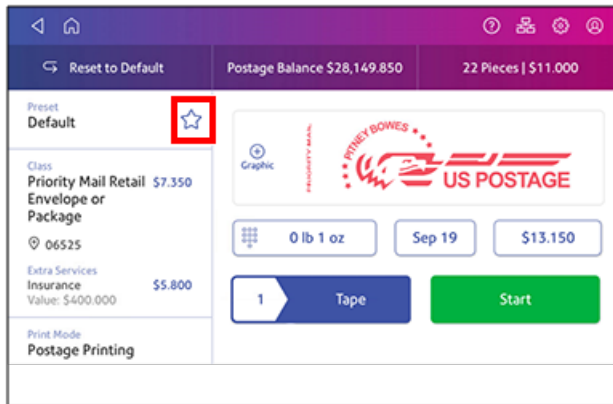

5. Tap **Save New Preset** to save it. If you wish to save it and replace the default setting, tap **Replace Default Preset**.

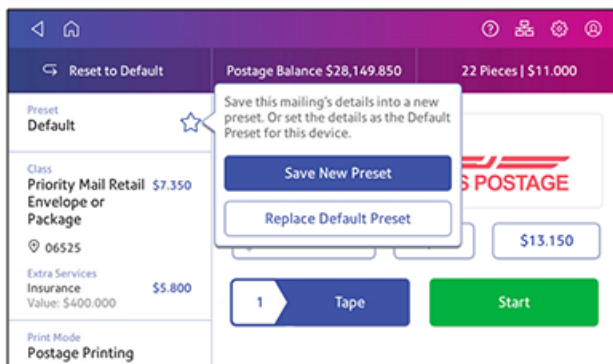

6. For a new preset, enter a name, then tap **Save**.

Selecting a preset for printing postage

Select a preset to quickly apply a group of settings.

1. Tap **Print on Envelopes** on the Home screen.
2. Tap **Preset**.
3. Tap the preset you want to use, then tap **Apply Preset**.

If you select a preset and do not use it within about one minute, the Print on Envelopes screen restores the default preset values. The same is true when you switch your device off or it enters sleep mode.

2 - Connectivity information

In this section

Setting up a wired network connection.....	32
Setting up a wireless (Wi-Fi) network connection.....	35
Connecting to a hidden Wi-Fi network.....	35
Forgetting a Wi-Fi network.....	37
Checking your network connection.....	39
Finding the MAC address for wired and wireless networks.....	39
Setting up a Proxy server.....	43

Setting up a wired network connection

Use a network cable to connect your device to the Pitney Bowes Data Center.

Step 1: Plug in your network cable

Plug one end of your network cable to your device and the other end to an internet jack on the wall or a router.

Step 2: Choose the connection type

Select one of the two connection types supported for this device:

- *DHCP*
- *Static IP*

DHCP is the most common connection type. Choose DHCP if you are unsure which connection protocol to use or contact your IT department for advice.

DHCP

1. Tap **Settings**.



2. Tap **Wired**.

3. Select **DHCP**.

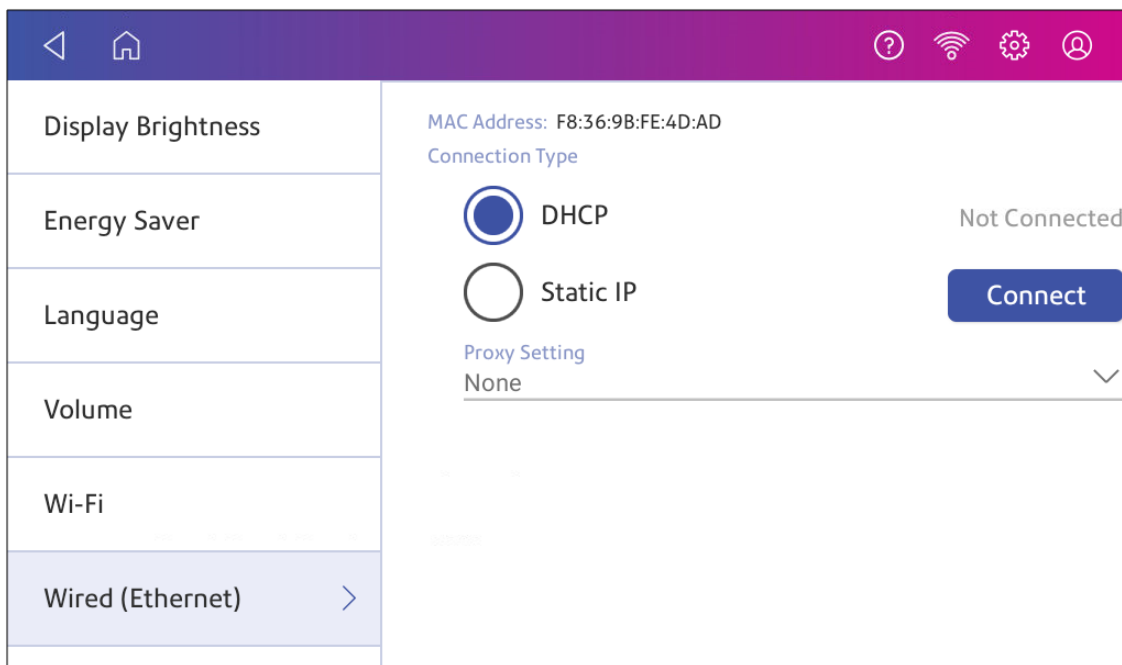

4. Tap **Connect**.
5. If it does not connect, unplug the power cord.
6. Wait 30 seconds. The screen should turn off after 10 seconds.
7. Plug the power cord back in directly into a wall outlet.
8. Quickly tap and release the power button to turn the device back on.
9. Tap **Settings**.



10. Tap **Wired (Ethernet)**.
11. Tap **DHCP**.
12. Tap **Connect**.

Static IP

1. Tap **Settings**.



2. Tap **Wired**.
3. Select **Static**.

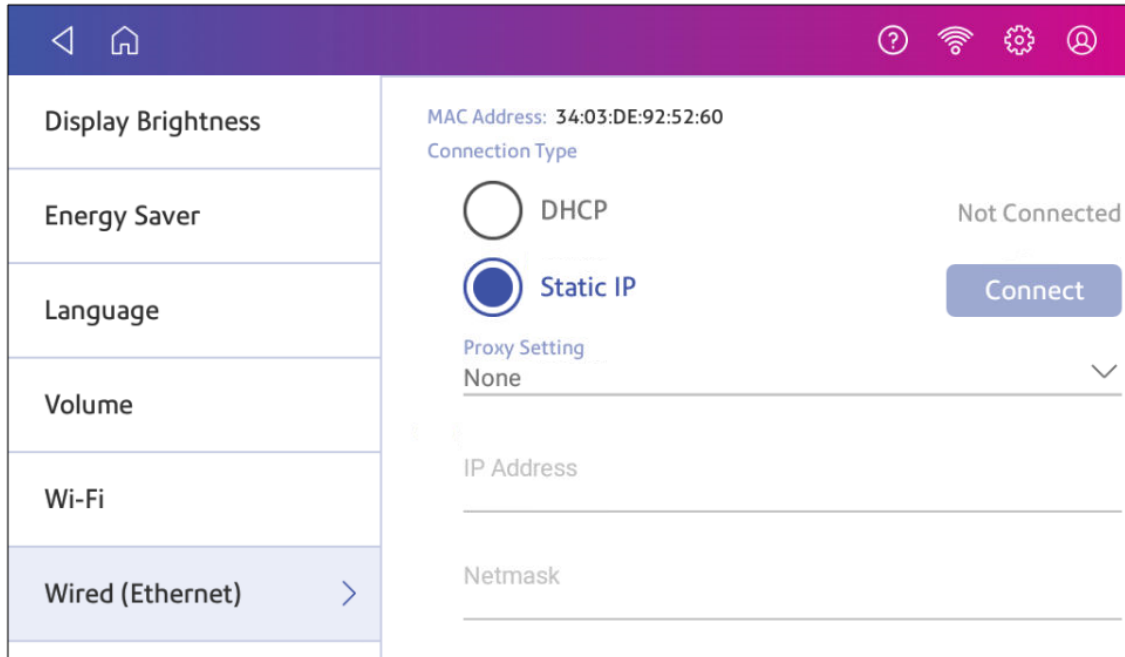

4. Contact your IT department to obtain the settings you will need to enter for your device. The values needed are:
 - **IP Address**
 - **Netmask**
 - **Gateway**
 - **DNS Address.**
5. Enter the settings you obtained in step 4 for the **IP Address**, **Netmask**, **Gateway**, and **DNS Address** in the corresponding fields.
6. Tap **Connect**.
7. If the device fails to connect, remove the network cable from the back of the device.
8. Tap **Connect**. Wait for the attempted connection to fail.
9. Plug the network cable back in.
10. Delete the values in the **IP Address**, **Netmask**, **Gateway**, and **DNS Address** fields.
11. Enter the **IP Address**, **Netmask**, **Gateway**, and **DNS Address** that you obtained in step 4.
12. Tap **Connect**.

NOTE: If your device's model number is 8H00 or 9H00 it will remember the Static IP information even if you switch back to DHCP and then back again. This information includes IP Address, Netmask, Gateway and DNS Address as well as the proxy information.

Setting up a wireless (Wi-Fi) network connection

You can connect your device with a wireless network connection.

1. Tap **Settings**.



2. Tap **Wi-Fi** in the Device & Network section.
3. Choose your Wi-Fi network from the list. Tap **Add Network** if your Wi-Fi network does not appear.
4. Enter your Wi-Fi password.
Tip: Use the show password option to make sure that you enter your password correctly.
5. Tap **Advanced Options** if your network requires advanced network settings such as a Static IP address:
 - To set up a Static IP address:
 - a. Select the **IP Setting** menu and choose **Static**.
 - b. Tap on the line and enter the value provided by your IT department.
 - c. Tap the > in the green circle.

Connecting to a hidden Wi-Fi network

Add a network when you want to connect using Wi-Fi and your network is not present in the Wi-Fi list.

1. Tap **Settings**.



2. Tap **Wi-Fi** in the Device & Network section to see a list of available networks.

3. Tap **Add Network** at the top of the Wi-Fi screen.

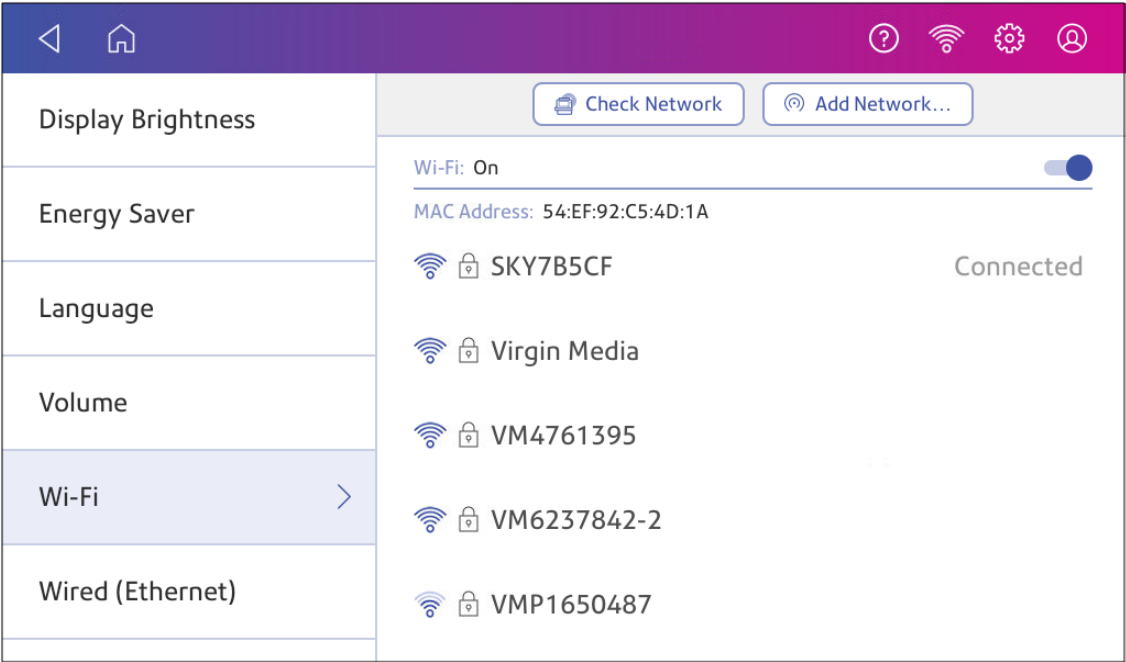

4. For each of the following steps, please consult with your IT department to obtain the necessary information.
 - a. Tap the down arrow in the Security field and select the security method.

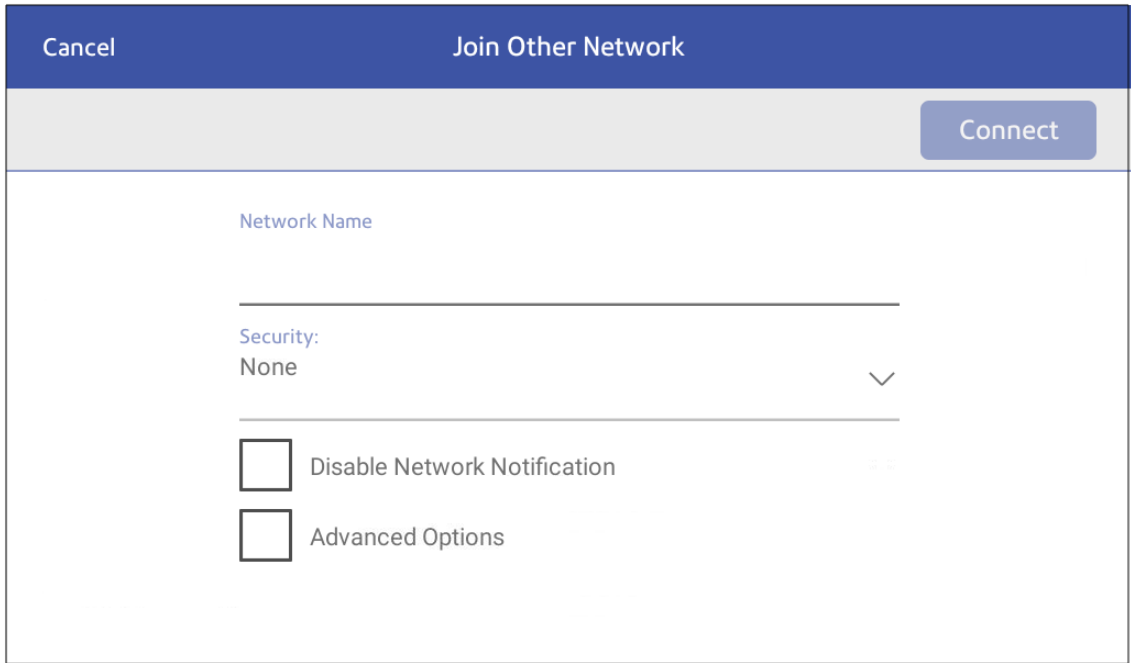

- b. Tap **Advanced Options** to enter a static IP or set up a proxy.
5. Tap **Connect** when done.

Forgetting a Wi-Fi network

Forget a Wi-Fi network if:

- You do not want your device to automatically connect to that network or
- You need to resolve a wireless network issue.

1. Tap **Settings**.



2. Tap **Wi-Fi** in the Device & Network section.

3. Tap the network you want to forget. You can only forget a network if you've connected to it before.

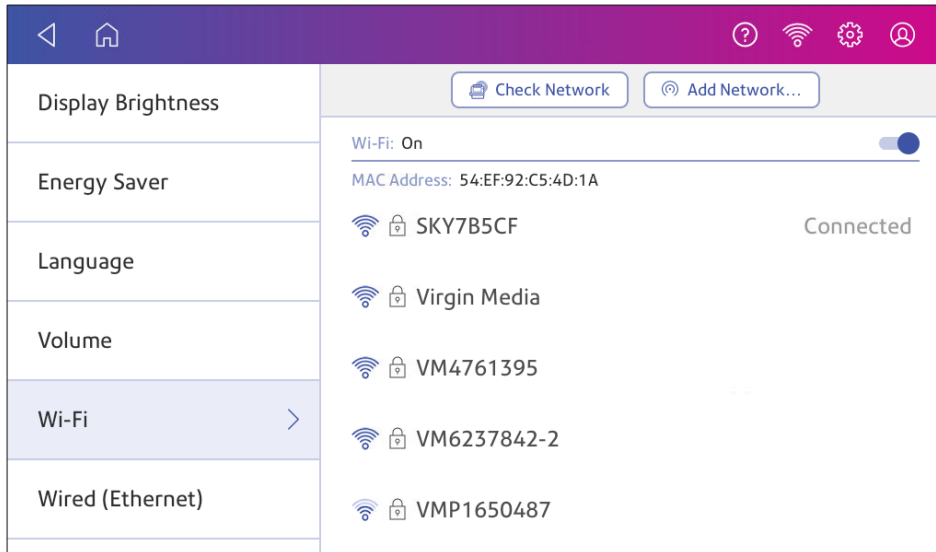

The network details appear.

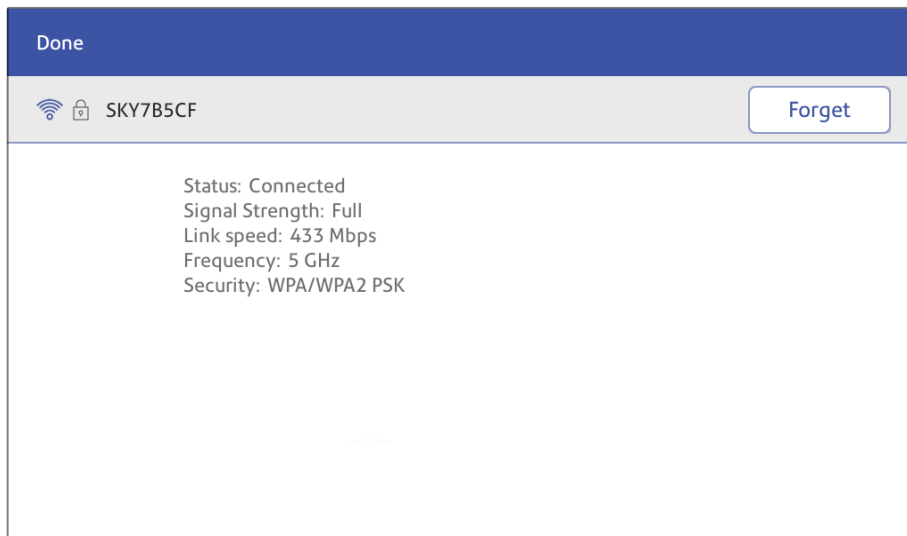

4. Tap **Forget** to forget the network connection.

Checking your network connection

Use the Network Connection app to check that you have the necessary internet services to connect to the internet. The app helps diagnose network connection issues.

Your IT department may be blocking certain services. Only they will know if the necessary services are available on your network.

1. To open and run the network checking app:
 - Tap **SendPro Apps** on the Home screen, then tap **Network Connection**.
2. The device then provides you with the results of the network check.
3. Tap **Close** twice to return to the Home screen.

If you are unable to connect to the internet, ask your IT department or internet provider to check the internet settings before you contact Pitney Bowes.

Finding the MAC address for wired and wireless networks

The MAC address is the network identifier for the device. IT uses it to allow the device onto the network.

Your device contains two MAC addresses: One for wireless connections and one for wired connections.

Locating the MAC address for wireless connections

1. Tap **Settings**.



2. Tap **Wi-Fi**.

3. The MAC address appears above the list of wireless networks.

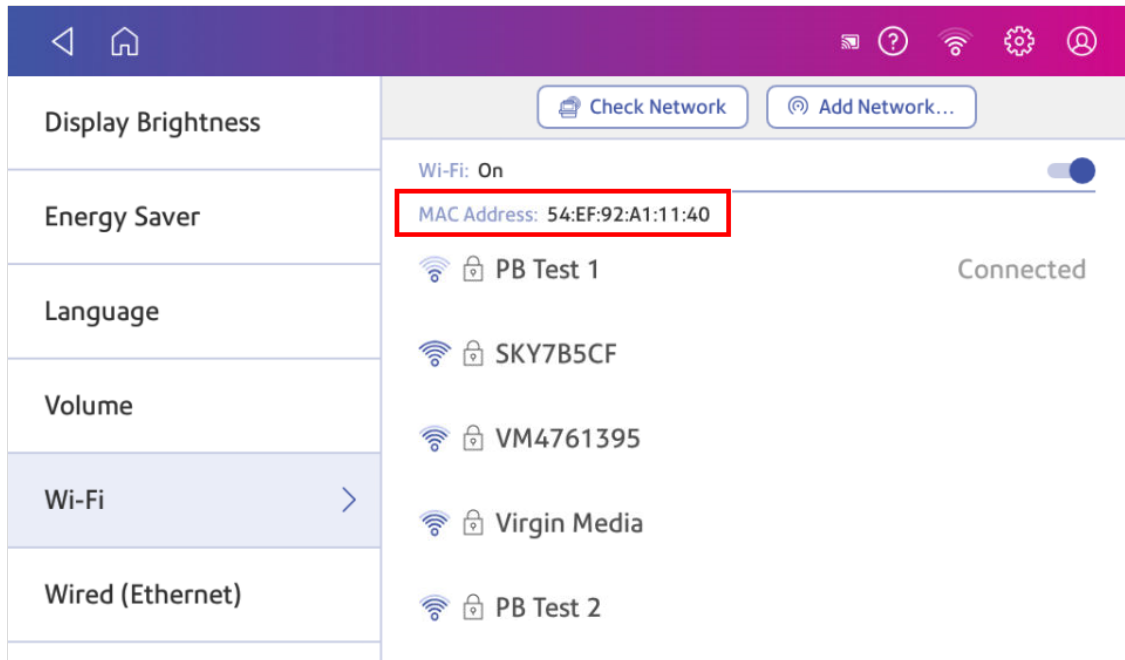

Locating the MAC address for wired connections

1. Tap **Settings**.



2. Tap **Wired (Ethernet)**. The MAC address is present at the top of the screen.

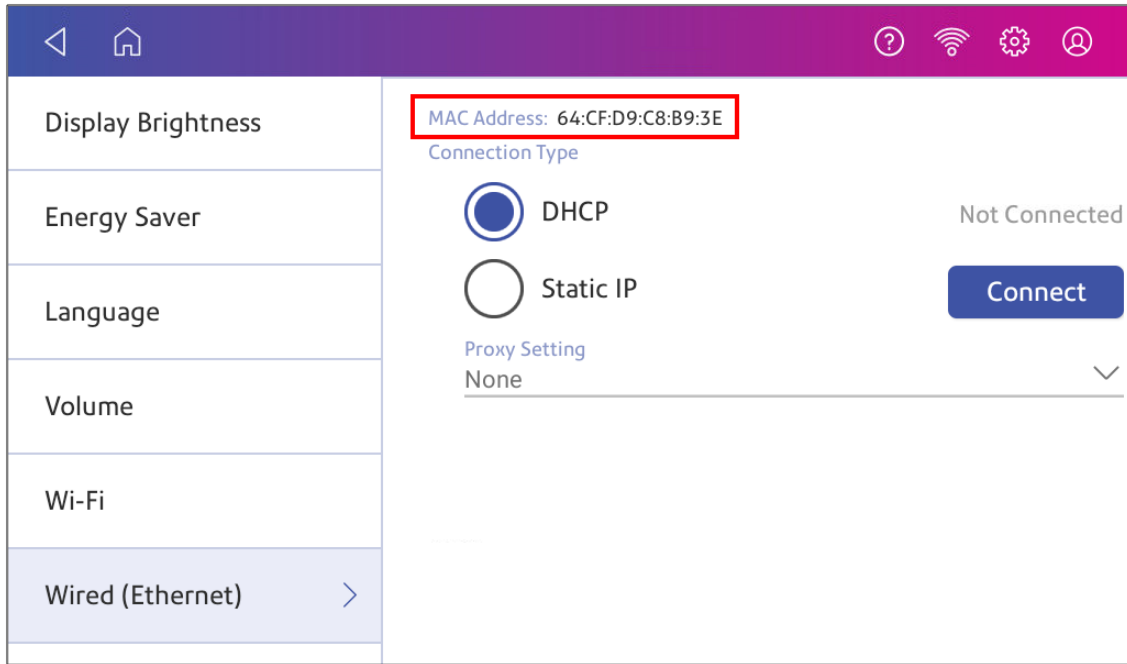

3. Tap **Check Network**. The Checking Network Connection screen appears.

4. Tap **View Details** in the Connected to wired network box when the test finishes.

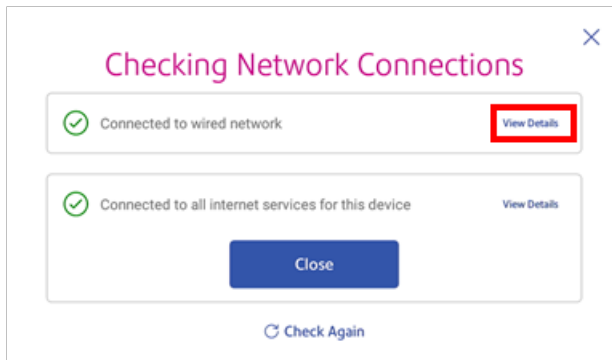

The MAC address appears:

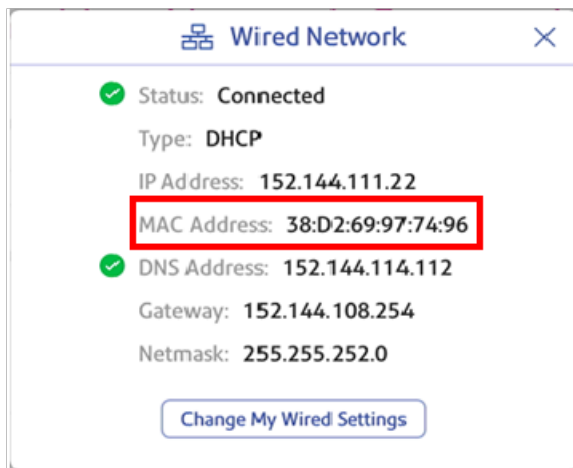

5. Tap **X** to close this window.
6. Tap **Close**, then the **back arrow** to return to the Home screen.

If the MAC address does not appear, try these steps:

1. Tap **Settings**.



2. Scroll down to the Advanced Device Options section and tap **About this C-Series**.

3. Scroll down to the Base Network Info section to locate the MAC Address.

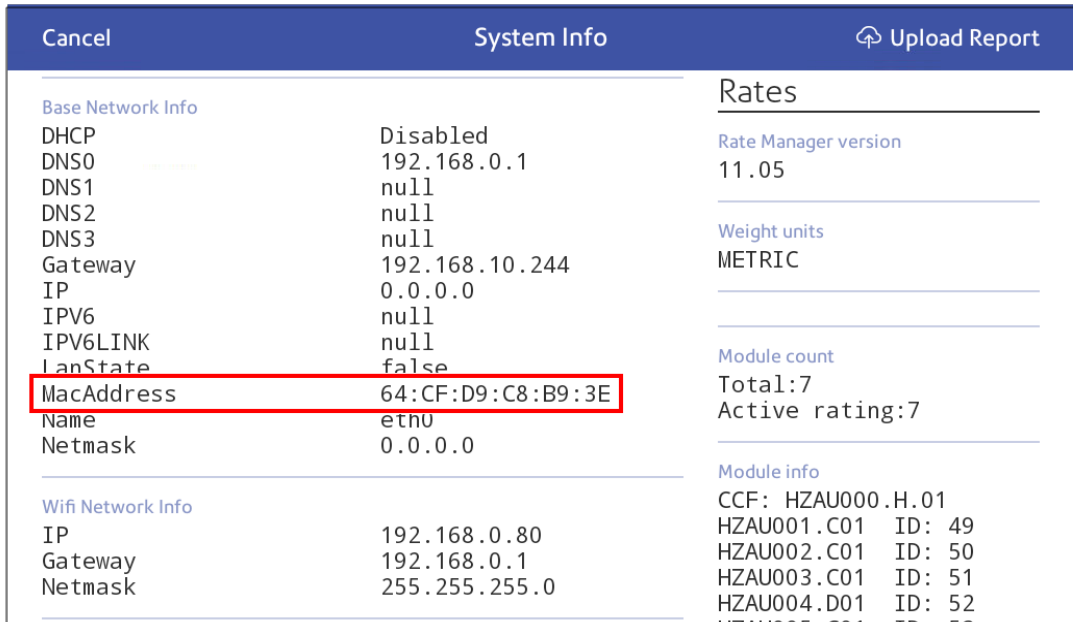

4. Tap **Cancel** to return to the Home screen.

Setting up a Proxy server

A Proxy server is a computer that acts as a gateway between your local network, your device, and the internet. Proxy servers provide increased performance and security.

If your network requires a proxy server, you must contact your IT department or service provider to obtain the proxy server information to set up a proxy server.

Choose the connection type

Choose how you connect your device to set up a Proxy server:

- [Setting up a Proxy server using a Wi-Fi network connection](#)
- [Setting up a Proxy server using a wired network connection](#)

Setting up a Proxy server using a Wi-Fi network connection

1. Tap **Settings**.



2. Tap **Wi-Fi** in the Device & Network section.
3. Select the network from the list.
4. Tap on the **Advanced Options** checkbox to select it.
5. Scroll down and tap the arrow next to Proxy, then select **Manual**.

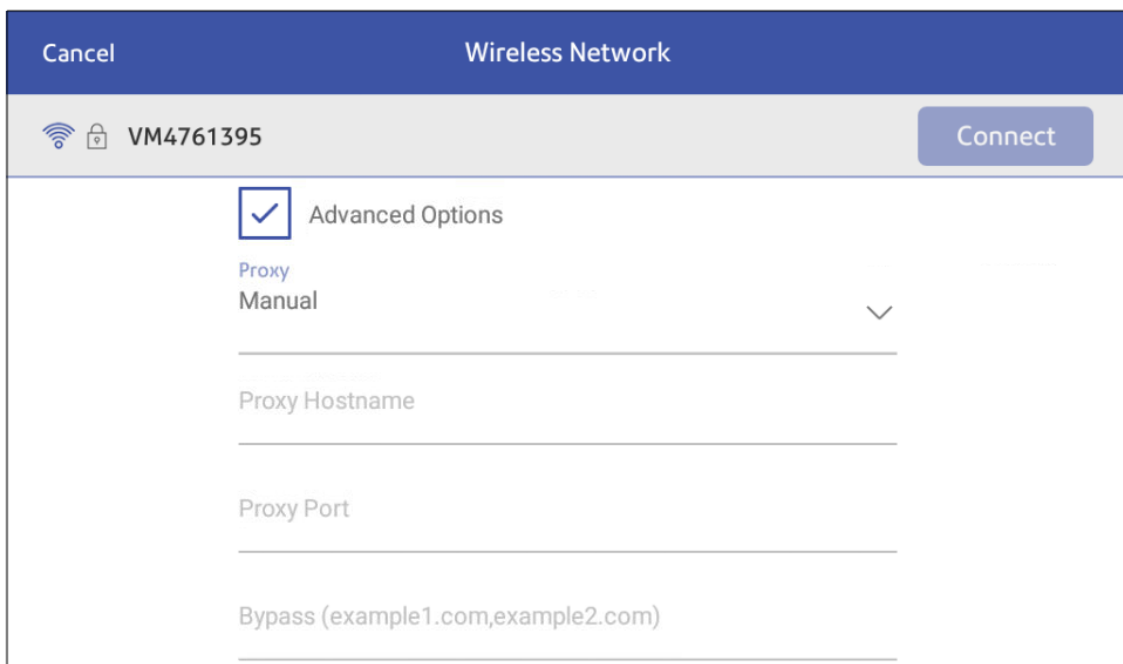

6. Enter the IP address, HTTP or HTTPS proxy address of your proxy server in the **Proxy Hostname** field.
7. Enter the port number for the proxy server in the **Proxy Port** field.
8. (Optional) Enter any specific URLs or URL patterns (such as internal addresses) that you wish to bypass the proxy in the **Bypass** field.

9. If your Proxy Server requires authentication, select the **Need Authentication** check box. Additional fields appear.
 - a. Enter the Proxy username in the **Proxy Username** field. This may be case sensitive for some proxy servers.
 - b. Enter the Proxy password in the **Proxy Password** field. This is case sensitive for proxy servers.

Setting up a Proxy server using a wired network connection

1. Tap **Settings**.



2. Tap **Wired (Ethernet)** in the Device & Network section.
3. Select either **DHCP** or **Static IP**.
4. If you select DHCP, tap on the drop-down arrow next to Proxy Setting and select **Manual**.

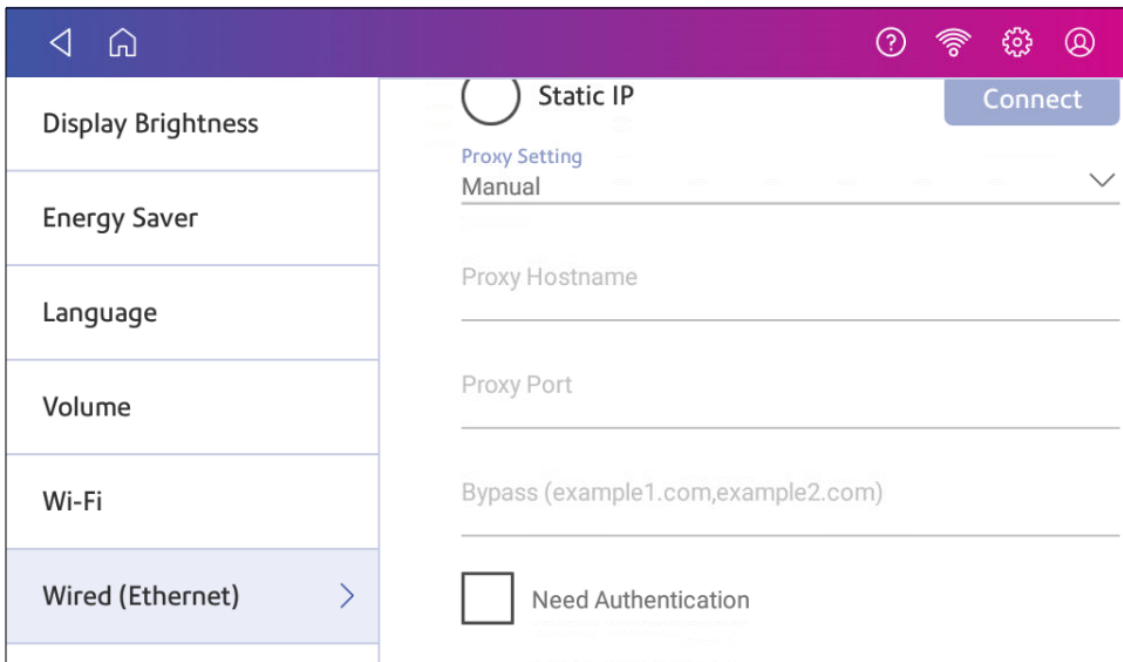

5. Enter the IP address, HTTP or HTTPS proxy address of your proxy server in the **Proxy Hostname** field.
6. Enter the port number for the proxy server in the **Proxy Port** field.

7. (Optional) Enter any specific URLs or URL patterns (such as internal addresses) that you wish to bypass the proxy in the **Bypass** field.
8. If your Proxy Server requires authentication, select the **Need Authentication** check box. Additional fields appear.
 - a. Enter the Proxy username in the **Proxy Username** field. This may be case sensitive for some proxy servers.
 - b. Enter the Proxy password in the **Proxy Password** field. This is case sensitive for proxy servers.

3 - Managing your Device

In this section

Creating or disabling the security PIN.....	48
Resetting a forgotten security PIN.....	49
Adjusting time zone and scale location code.....	49
Adjusting display brightness.....	50
Adding favorite apps.....	50
Setting up the Energy Saver.....	51
Setting up the Screen Saver.....	52
Using USPS Informed Delivery.....	52
Uploading system logs.....	53

Creating or disabling the security PIN

Create a security PIN to prevent unauthorised use of your device.

If you created a security PIN when you installed your device, you must enter it when you turn your device on or after it enters sleep mode.

Create a security pin

1. Tap **Settings**.



2. Tap **Security PIN** in the Device & Network section.
3. Tap **Create PIN**.
4. Enter a 4-digit numeric PIN using the keyboard on the display.
5. Verify your PIN by entering it again.

Change or disable the security PIN

1. Tap **Settings**.



2. Tap **Security PIN** in the Device & Network section.
3. Tap **Change PIN** or **Turn OFF Security PIN**.
4. Enter the current security PIN for either option.

Manually lock your device

1. Tap the user profile image.



2. Tap **Lock this device**. The screen saver displays shortly after the Device is Locked screen appears.

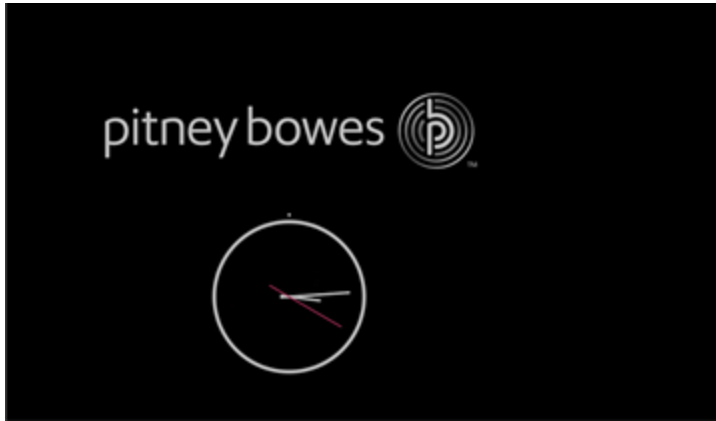

If you forget your Security PIN, tap on the **Forgot PIN?** link to get help.

Resetting a forgotten security PIN

If you are locked out of your system, you can reset your security PIN.

1. On the lock screen, click **Forgot Pin**.
2. Tap **Reset Now**.

If you need further assistance, please chat with us.

Adjusting time zone and scale location code

When you move your device to a new location or install a new scale, you must modify the location code and time zone value.

1. Tap **Settings**.



2. Tap **Location & Time Zone**.
3. Enter the new location code.

4. Enter the time zone.
5. Tap **Apply**.

Adjusting display brightness

Set the brightness of the display to suit your work space.

1. Tap **Settings**.



2. Tap **Display Brightness** in the Device & Network section of the screen.
3. Move the slider to adjust the brightness.
4. Tap the **back arrow** or **Home** to exit the Settings screen.

Adding favorite apps

Add your favorite apps to make them easy to find on the Home screen.

1. Tap **SendPro Apps** on the Home screen. All the available apps display.
2. Tap **Edit Favorites** and a star appears next to each app.

3. Tap the star next to an app to make it a favorite.

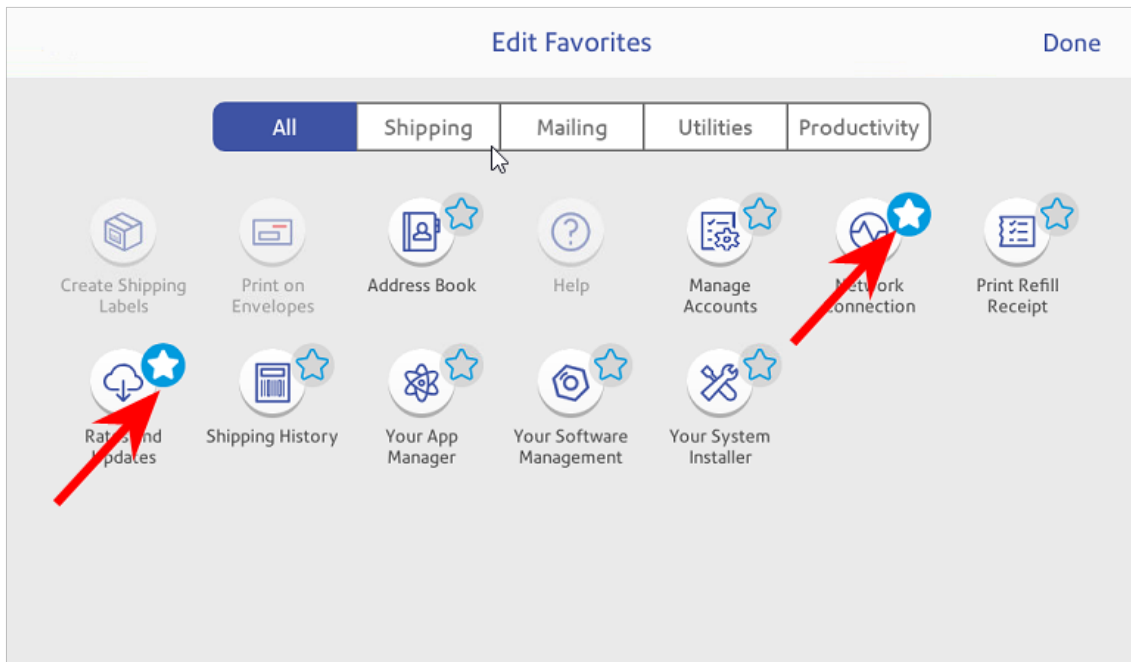

4. Tap **Done** when complete.

Setting up the Energy Saver

Use the energy saver to reduce energy usage. The energy saver turns your device off after a period of inactivity.

1. Tap **Settings**.



2. Tap **Energy Saver** in the Device & Network section.
3. Tap in the **Time after inactivity to turn off** field.
4. Select the amount of time you want your device to remain inactive before it shuts down. The shorter the time you select, the more energy you save.

Setting up the Screen Saver

Your device saves energy by dimming the screen after a period of inactivity.

1. Tap **Settings**.



2. Tap **Power Settings** in the Device & Network section.
3. Tap **Screen Saver**.
4. Set the **Time after inactivity that we activate the screen saver**. The shorter the time you select, the more energy you save.

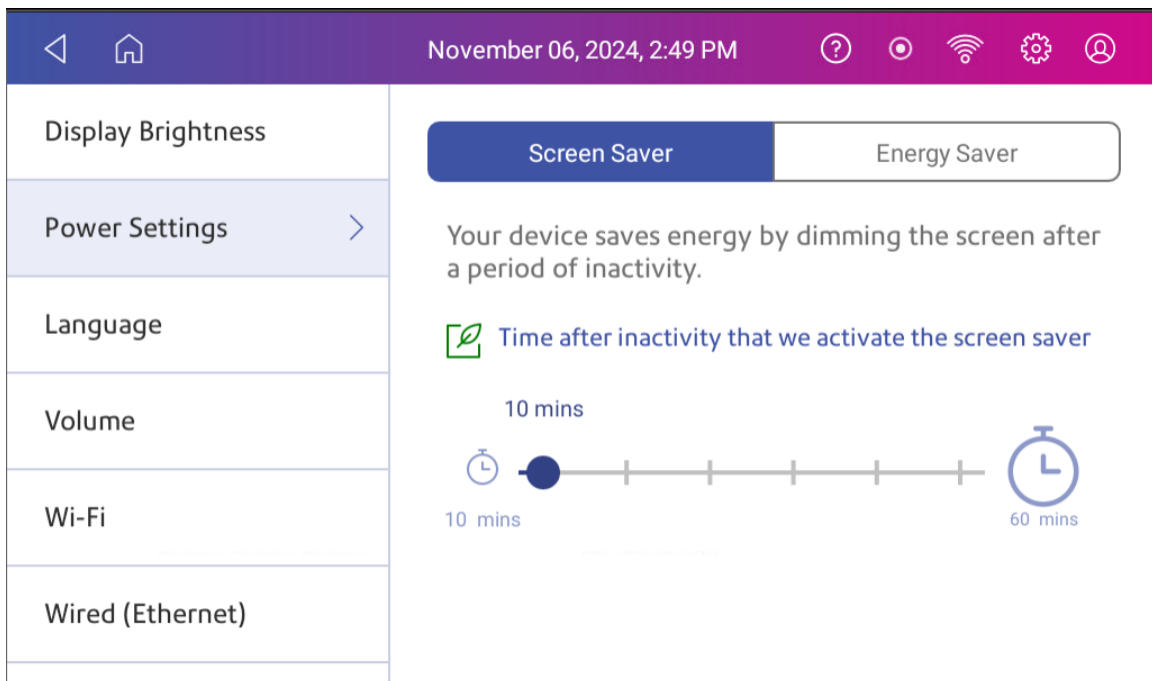

Using USPS Informed Delivery

USPS Informed Delivery allows you to preview your mail and manage your packages. Informed Delivery allows you to:

- View grayscale images of the exterior, address side of letter-sized mailpieces.
- Track packages in one app.

For more information on USPS Informed Delivery, go to the USPS Informed Delivery website.

1. To access USPS Informed Delivery:
 - Tap **SendPro Apps** on the Home screen, then tap **USPS Informed Delivery**.
2. Enter your USPS.com username and password.
 - If this is the first time you are using Informed Delivery on your device, you need to verify your USPS account. Follow the prompts to complete the verification process.

Uploading system logs

Your device creates system logs that monitor operations on your device. If you need to upload system logs to a Pitney Bowes support representative, you can find them in the Advanced Device Options section under Settings.

1. Tap **Settings**.



2. Scroll down to the Advanced device Options section.
3. Tap **System Log Upload**.
4. Select the logs you want to upload.

5. Tap **Upload Selected Logs**.

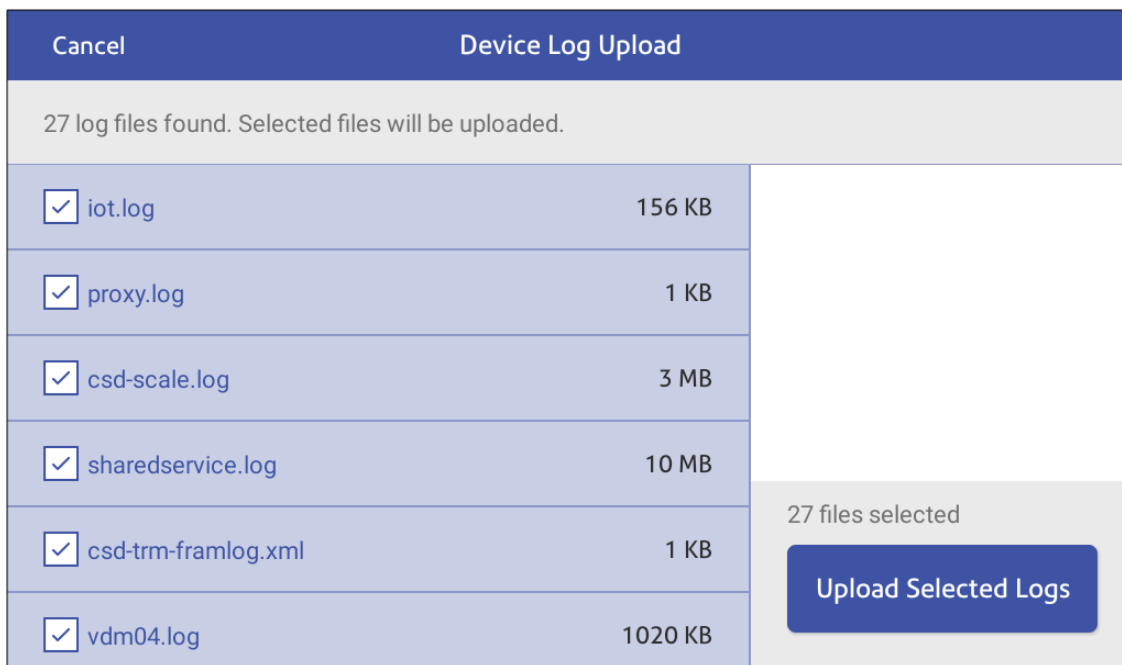

6. The message **Sending Log Files** appears. Once the upload is complete, the message **Upload Complete** appears.
7. Tap **Got It** to return to the Home screen.

4 - Printing on envelopes

In this section

Navigating the Print on Envelopes app.....	56
Checking the available funds for printing postage.....	57
Adding or refilling postage for printing on envelopes.....	59
Sending a First-Class Mail envelope.....	60
Sending a large First-Class® envelope.....	61
Sending Certified Mail.....	62
Sending an international letter.....	63
Sending mail using a Certificate of Mailing.....	63
Advancing the date.....	65
Printing postage without a date for pre-printed mailpieces.....	65
Printing additional postage.....	66
Re-dating your mail.....	67
Using USPS special services.....	68
Using the scale when printing postage.....	68
Sealing envelopes when you print postage.....	70
Sealing envelopes without printing postage.....	71
Zeroing the scale.....	72
Adding insurance to your mail.....	73
Printing a custom or standard graphic.....	74
Sending mail using Electronic Return Receipt (ERR).....	77
Getting a USPS refund for damaged or incorrectly printed mail.....	78
Creating a custom text message for your mail.....	79
Adding a custom text message to your envelope or tape.....	81
Editing or deleting a custom text message.....	83
Printing a graphic without printing postage.....	85

Adding an inscription..... 86
 Printing only the date and time..... 86
 Setting the right margin adjustment..... 88

Navigating the Print on Envelopes app

The Print on Envelopes app is the starting point for printing postage on an envelope or a tape. It also allows you to change what you print.

To open the Print on Envelopes app, tap **Print on Envelopes**.

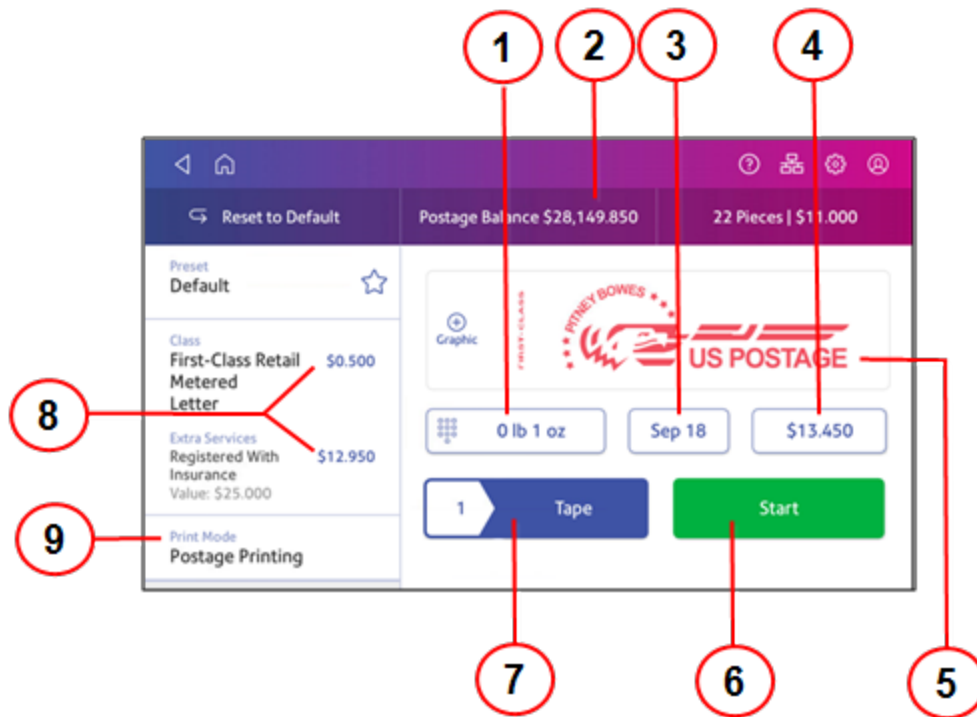

On this screen, you can:

1. Tap the weight to view the weighing options. You can enter the weight manually or use a scale.
2. View the balance of funds you have remaining in your device.
3. Tap the date to view the date options.
4. View the total postage amount.
5. Preview or add graphics.

6. Tap **Start** to begin feeding and printing postage on the envelopes loaded on the feed deck. The **Start** button is only present on SendPro C models equipped with an automatic feeder.
7. Tap **Tape** to begin printing postage on tape. To print more than one tape, tap the number next to **Tape** and enter the number of tapes. **Tape** is only present on SendPro C models equipped with an automatic feeder.
8. Tap **Class** to view the class and any extra services.
9. Tap **Print Mode** to access the Print Mode screen. This provides you with different printing modes such as adding graphics to your envelope, adding more postage, or making corrections to the date. You can also choose to seal envelopes without printing postage.

Checking the available funds for printing postage

Check your funds for printing postage on your device at any time.

Viewing the amount available in your device

1. Tap **Print on Envelopes** on the Home screen.
2. The **Postage Balance** shows the available funds in your device.

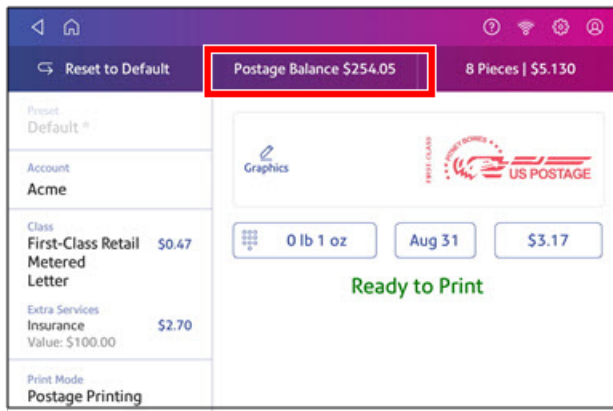

Viewing the amount available in your postage account at Pitney Bowes

1. Tap **Print on Envelopes** on the Home screen.
2. Tap **Postage Balance**.
3. Tap **Settings**.

4. The balance in your postage account appears.

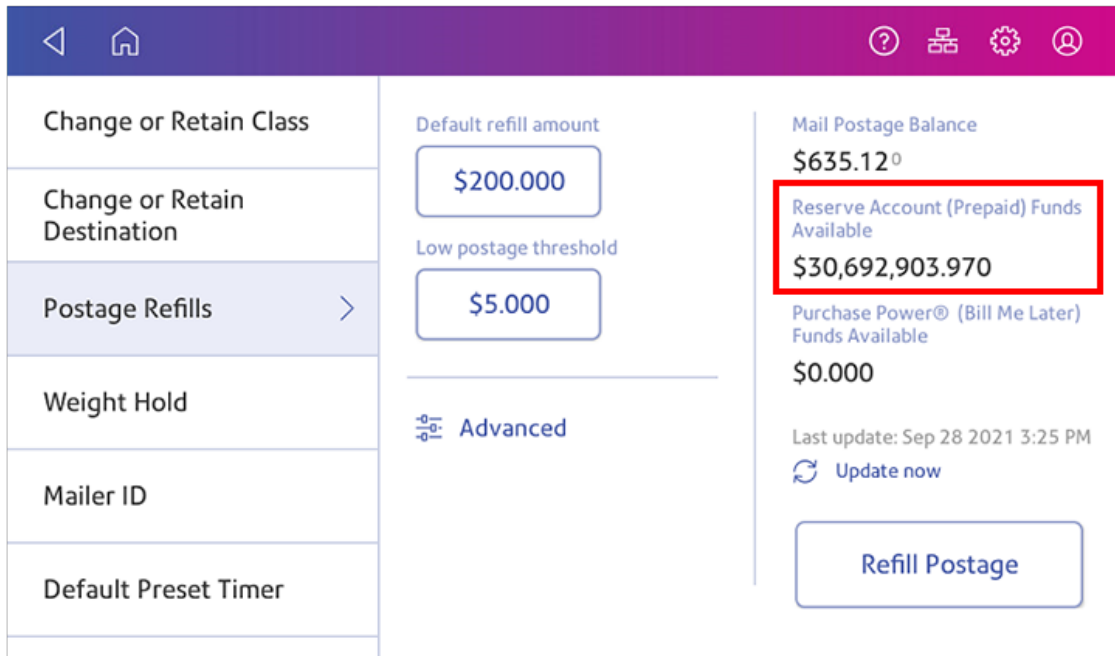

Adding or refilling postage for printing on envelopes

Add or refill postage for your Print on Envelopes balance as soon as you receive a message that your funds are getting low.

Before you begin

Check that your device is connecting to the internet.

- For wired network connections, the following connection image appears in the toolbar:



- If you have a wireless connection, the following connection image appears in the toolbar:



Add postage for Printing on Envelopes

1. Tap **Print on Envelopes** on the Home screen.
2. Tap **Postage Balance**.
3. Tap **Refill Postage**.
4. Enter the amount of postage you wish to add.
5. Tap **Refill Mail Postage**.
6. Tap **View Receipt** to view or print a receipt.
7. Tap **Done**.
8. Your updated postage balance appears on the Print on Envelopes app.

Sending a First-Class Mail envelope

First-Class Mail is an economical way to send mailpieces through the USPS. You can send standard postcards, letters, and large envelopes and small packages up to 15.99 ounces.

1. Tap **Print on Envelopes** on the Home screen.
2. If you have the accounting feature enabled, tap **Account** and select an account.
3. Tap **Class**.
4. Tap **Start Over** to show a list of all the available classes.
5. Tap **First-Class Retail Metered** for a First-Class Mail envelope.
6. Tap **Letter**.
7. Select any special services you wish to use.
8. Tap **Apply**.
9. Place the envelope on the scale. The weight appears.

10. Place the envelope or envelopes on the feed deck. Depending on the SendPro C model you have, feed the envelopes manually or tap **Start** to feed the envelopes.

Important: Your device will upload transactions if you have previously printed any mail. Once the upload completes, you see the message "Transaction upload status, Upload success" with a check mark. Tap the check mark.

Sending a large First-Class® envelope

Before you select a rate for a large envelope, you need to determine whether the mailpiece you are sending is a letter or large envelope according to the USPS.

If your mailpiece weighs more than 3.5 oz, the device automatically sets the class to Large Envelope regardless of the dimensions. If the mailpiece weighs less than 3.5 oz but has the dimensions of a large envelope, you need to manually select Large Envelope when you choose the class.

Weigh the mailpiece and measure the dimensions

1. Tap **Print on Envelopes** on the Home screen.
2. If you have the accounting feature enabled, tap **Account** and select an account.
3. Place the mailpiece on the scale. The weight appears. You can also weigh the mailpiece using any other postal scale.

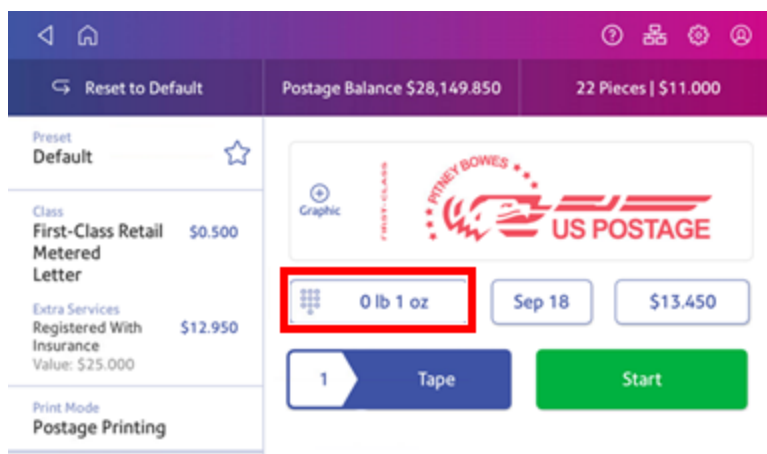

4. Measure and record the dimensions of the mailpiece.
5. Tap **Home** to return to the Home screen.

If the mailpiece is less than 3.5 oz, but has the dimensions of a large envelope:

1. Tap **Home**.
2. Tap **Print on Envelopes**.
3. If you have the accounting feature enabled, tap **Account** and select an account.
4. Tap **Class**.
5. Tap **Start Over** to show a list of all the available classes.
6. Tap **First-Class Retail Metered** for a First-Class mail envelope.
7. Tap **Large Envelope**.
8. Select special services, if required.
9. Tap **Apply**.
10. Place the envelope or envelopes on the feed deck. Depending on the SendPro C model you have, feed the envelopes manually or tap **Start** to feed the envelopes.
If the envelope is too thick to go through the feeder, print the postage on a tape and apply the tape to the large envelope or flat.

Sending Certified Mail

Certified Mail is a USPS service that provides you with proof of mailing by sending you a receipt once your mailpiece arrives at its destination.

Not all extra services like Certified Mail are available for all classes and you can only combine certain services.

1. Tap **Print on Envelopes** on the Home screen.
2. If you have the accounting feature enabled, tap **Account** and select an account.
3. Tap **Class**.
4. Tap **Start Over** to show a list of the available classes.
5. Tap a class that you can combine with Certified Mail (for example, First Class or Priority Mail).
6. Tap the mailpiece type (for example, letter or large envelope).
7. Select **Certified** and tap **Apply**.
8. Depending on the type class and type of mailpiece, enter the destination ZIP Code and tap **Apply**.
9. Place the envelope or envelopes on the feed deck. Depending on the SendPro C model you

have, feed the envelopes manually or tap **Start** to feed the envelopes.

10. Place the green Certified Mail label (USPS Label 3800) on the mailpiece.

Sending an international letter

Use this process if you need to send mail from the United States to a different country.

1. Tap **Print on Envelopes** on the Home screen.
2. If you have the accounting feature enabled, tap **Account** and select an account.
3. Tap **Class**.
4. Tap **Start Over** to display a list of all the available classes.
5. Tap **First-Class Mail Intl Retail** for a First-Class Mail envelope.
6. Tap **Letter**.
7. Tap in the **Country** field and use the keypad to enter the destination country.
8. Select special services, if required.
9. Tap **Apply**.
10. Place the envelope on the scale. The weight appears.
11. Place the envelope or envelopes on the feed deck. Depending on the SendPro C model you have, feed the envelopes manually or tap **Start** to feed the envelopes.

Important: Your device will upload transactions if you have previously printed any mail. Once the upload completes, you see the message "Transaction upload status, Upload success" with a check mark. Tap the check mark.

Sending mail using a Certificate of Mailing

Purchase a Certificate of Mailing when you need to have proof that you sent a letter or package.

You can only obtain a Certificate of Mailing from the USPS. A Certificate of Mailing is a receipt that provides evidence of the date that you took your mail to the USPS for mailing. You cannot produce this certificate with your device. It is a record of when you turned the mailpiece over to the Post Office and you can only get it from the USPS.

1. Fill out the USPS postal forms [3606-D](#), [3665](#), or [3817](#). Obtain these at the Post Office or online at the [USPS website](#).
2. Calculate the fees for all of the mailpieces. This can include the cost of the Certificate of Mailing fees as well as the total postage amount.

3. Tap **Print on Envelopes** on the Home screen.
4. If you have the accounting feature enabled, tap **Account** and select an account. If your device's model number is 8H00 or 9H00 and if you have only a single account, once you select that account the device will remember that account the next time you start Print on Envelopes.
5. Scroll down and tap **Print Mode** on the Print on Envelopes screen.
6. Tap **Certificate of Mailing**.

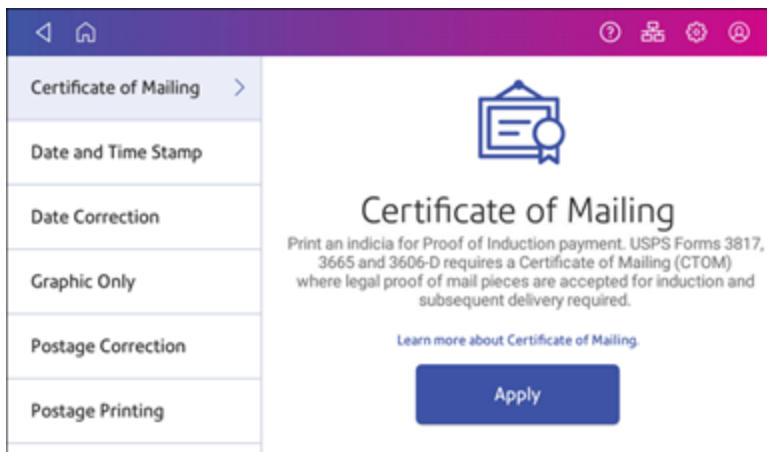

7. Tap **Apply**.

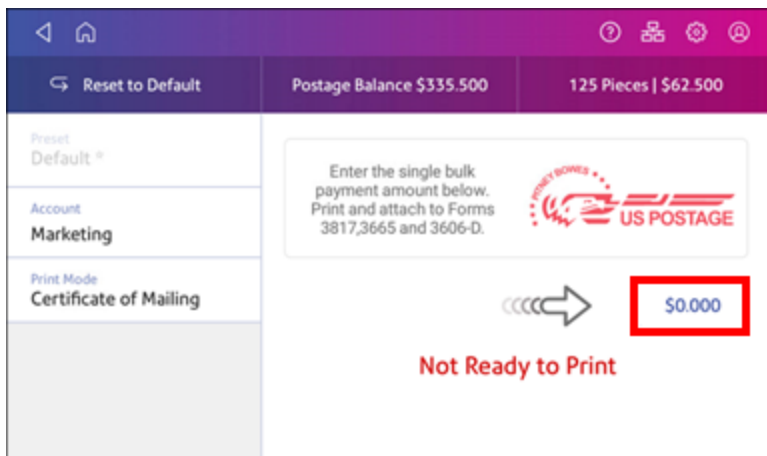

8. Tap on the postage amount and enter the amount you calculated in step 2.
9. Feed the appropriate form (3606-D, 3665, or 3817) through the feeder so that the device stamp prints on the form or on a tape strip that can be applied to the form. Alternatively, you can print the device stamp on each of the mailpieces included in the Certificate of Mailing.
10. Take the mailpieces and the printed form to the Post Office. They will apply a round stamp proof of induction mark that serves as legal proof that your items will enter the USPS.

Advancing the date

Watch this video or follow the instructions below to learn how to advance the date.

Advance the date to print postage up to thirty days before you need to send it.

1. Tap **Print on Envelopes** on the Home screen.
2. Tap the date. The calendar appears.
3. Tap **Tomorrow** or **Another Date**, depending on the date you wish to print.
4. When you see the future date highlighted on the calendar, tap **Apply**.
5. Place the envelope or envelopes on the feed deck. Depending on the SendPro C model you have, feed the envelopes manually or tap **Start** to feed the envelopes.

Important: The date on the postage should match the date when your mail goes to the post office. Your device automatically advances the printed date on the device stamp (as well as its internally held date) when the device time reaches 5:00 PM. You cannot change this time.

Printing postage without a date for pre-printed mailpieces

If you wish to use a pre-printed return envelope, card, or label on which the postage is prepaid, you must print the postage without a date.

This feature is only available for Meter Reply Mail with First-Class Retail Metered classes that include Letter, Non-Machinable Letter, Large Envelope, and Postcard.

1. Tap **Print on Envelopes** on the Home screen.
2. Tap **First-Class Retail Metered Letter**.

3. On the Class & Extra Services screen, scroll down and tap the **Restricted Use Return Mail** box.

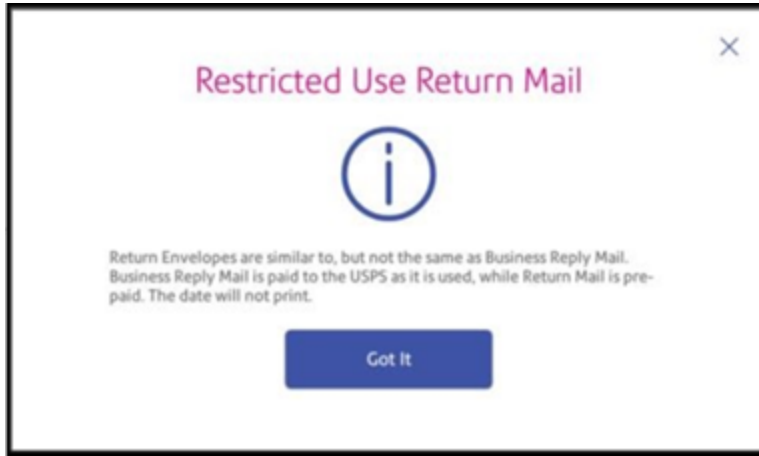

4. A message informs you that no date will print. Tap **Got it**.
5. Tap **Apply**.
6. **Restricted Use Return Mail** appears in the Extra Services box on the Print on Envelopes screen.

Printing additional postage

If you do not have enough postage on an envelope, you can add more postage directly on a blank area on your envelope or you can print the additional postage on a tape.

1. Tap **Print on Envelopes** on the Home screen.
2. Scroll down and tap **Print Mode**.
3. Tap **Postage Correction**.
4. Tap **Apply**.

5. Tap the postage amount.

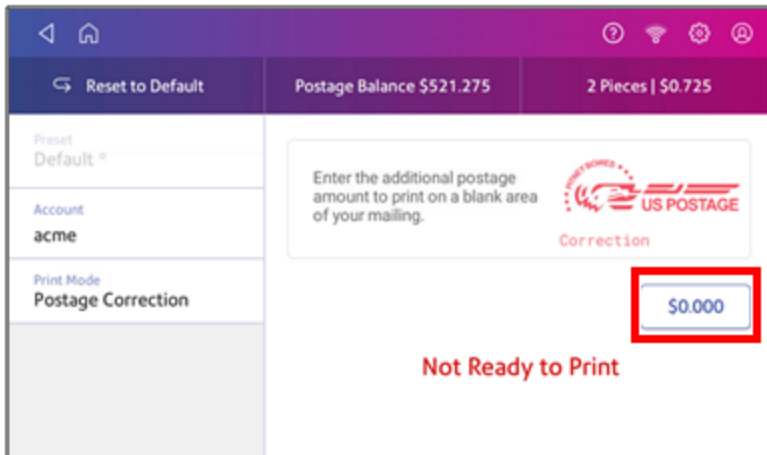

6. Use the keypad to enter the additional postage amount.
 7. Tap the check mark when done.
 8. Turn your envelope over to the blank side.
 9. Place the envelope or envelopes on the feed deck. Depending on the SendPro C model you have, feed the envelopes manually or tap **Start** to feed the envelopes.
- The word "Correction" appears on the postage mark:



Re-dating your mail

Watch this video or follow the instructions below to learn how to redate your mail.

If you already printed today's date and postage on an envelope, but you missed your mail pickup, you can re-date the mail. You must print a future date on the back of the envelope before you can mail it. You can only re-date one envelope at a time, even if you are feeding envelopes automatically.

1. Tap **Print on Envelopes** on the Home screen.
2. Scroll down and tap **Print Mode**.
3. Tap **Date Correction**.
4. Tap **Apply**.
5. Tap on the date.
6. Tap **Tomorrow** or **Another Date**, depending on the date you need.
7. Tap **Apply** after you select the new date.
8. Turn the envelope over to the blank side.
9. Place the envelope on the feed deck. Depending on the SendPro C model you have, feed the envelope manually or tap **Start** to feed the envelope. The word “Redate” appears on the newly printed print on the back of the envelope.

Using USPS special services

You can select additional services for your mail. These include Certified Mail, Insured Mail, Delivery Confirmation, Registered Mail and more. The number and types of services available depend on the class of mail.

1. Tap **Print on Envelopes** on the Home screen.
2. Tap **Class**.
3. Tap **Start Over** to see a list of the available classes.
4. Tap the class you wish to use. Sub-classes appear when available for the selected class.
 - For some classes, you must select the type of mailpiece. For example, if you select First-Class Retail Metered, you must select either Letter, Large Envelope, or Package.
5. Select any special services you wish to use.
6. Enter a ZIP code if required.
7. For some classes, you need to either scan or manually enter the Electronic Certified barcode from your label. Then, attach your label to your envelope or package.
8. Tap **Apply**.

Using the scale when printing postage

Use the scale to weigh your mail and calculate the correct postage for you.

1. Tap **Print on Envelopes** on the Home screen.
2. Tap **Weight**.

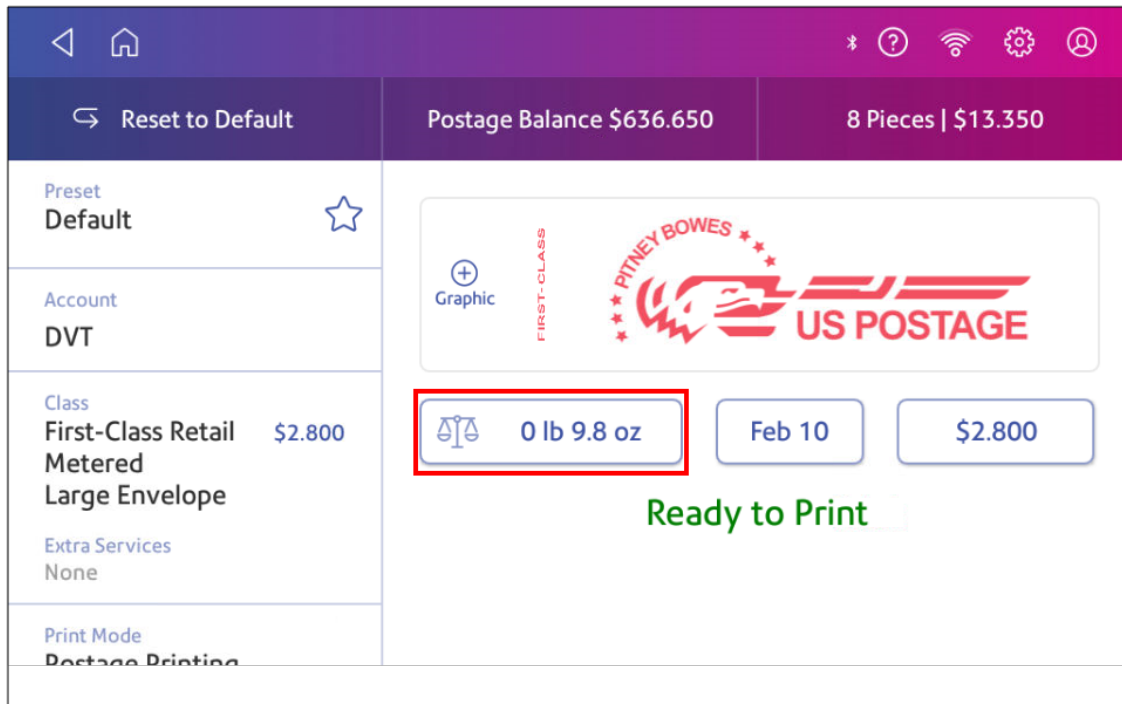

3. Tap **Scale**.
4. Place the envelope on the scale. You must do this before the next step or else the **Apply** button remains inactive.
5. Tap **Apply**.
6. Tap **Class**.
7. Select **Start Over** to show the class options.
8. Tap the class you want.
9. Select special services, if required.
10. Tap **Apply**.
11. Place the envelope or envelopes on the feed deck. Depending on the SendPro C model you have, feed the envelopes manually or tap **Start** to feed the envelopes.
12. The scale retains the weight of the mail for approximately 70 seconds. Add another mailpiece to the scale if you want to override the weight.

Sealing envelopes when you print postage

You can seal envelopes and print postage at the same time with your SendPro C Lite, SendPro C, SendPro+.

1. Check the level of sealing solution in the moistener tank. Add more if required.
2. Tap **Print on Envelopes** on the Home screen.
3. Tap **Account** and select an account if accounting is enabled on your device.
4. Tap **Weight**.

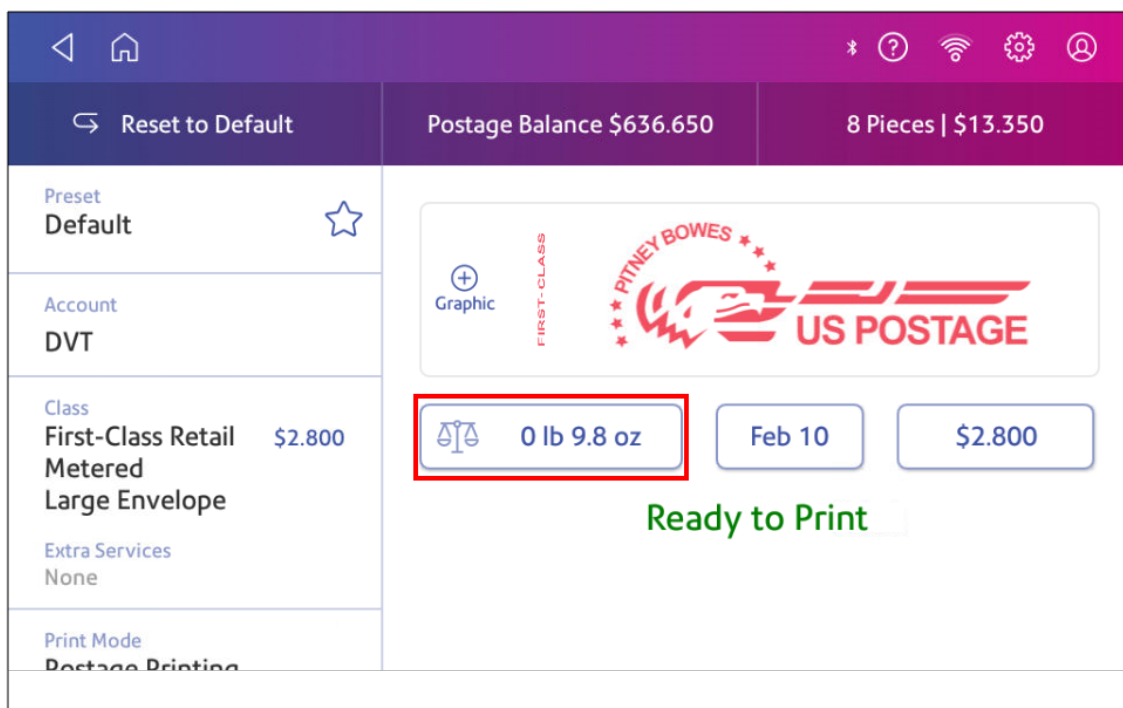

5. Tap **Scale**.
6. Place the envelope on the scale. You must do this before the next step or else **Apply** remains inactive.
7. Tap **Class** then select the class of mail you want.
8. Tap **Graphic** then select a graphic, if necessary.
9. Tap **Apply** to continue.

10. Slide the envelope flap under the edge of the feed deck so the moistener can wet the flap.



11. Insert the envelope into the device. The device prints the postage.

Important: If the moistener tank is full and your envelopes do not seal correctly, clean or replace the moistener brush and wick.

Sealing envelopes without printing postage

Use Seal Only mode to seal envelopes without printing anything.

1. Tap **Print on Envelopes** on the Home screen.
2. Tap **Print Mode**. You may need to swipe up on the screen to see this option.
3. Select **Seal Only**.
4. Tap **Apply**.

5. Place your envelope face up, flap down into the feeder. Be sure to slide the envelope flap under the edge of the feed deck.



6. Insert the envelope into the device. The device seals the envelope.



Zeroing the scale

Zero the scale to set the weight to zero.

Make sure there is nothing on the scale when you zero it.

1. Tap **Print on Envelopes** on the Home screen.
2. Tap **Weight**.

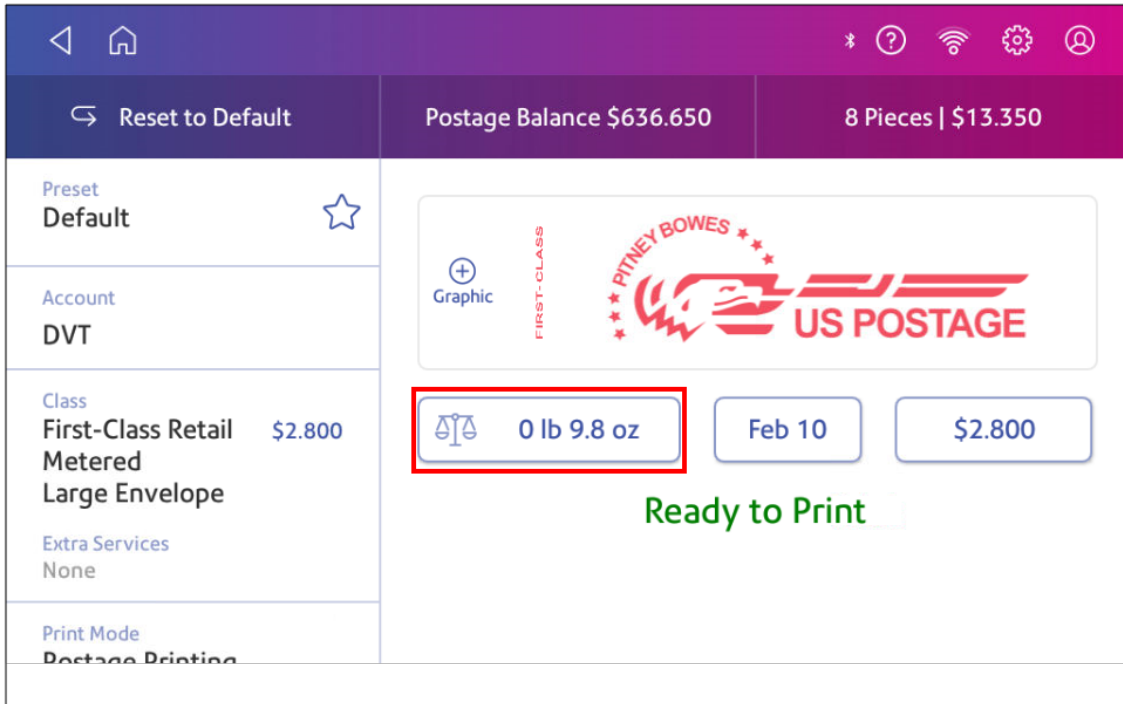

3. Tap **Scale** on the weighing method screen.
4. Tap **Zero Scale**.
5. Tap **Cancel** to return to the Print on Envelopes app.

Adding insurance to your mail

You can purchase insurance for your mailpiece to protect against loss, damage or missing contents. The insurance covers only the actual value of the mailed contents.

1. Tap **Print on Envelopes** on the Home screen.
2. Tap **Class**. If this is the class you need, tap the **Insurance** box, enter the amount, and tap **Apply**. If you need another class, go to step 3.
3. If you need a different class:
 - a. Tap **Start Over** and select a new class and any special services you need. Tap **Apply** after adding special services.
 - b. Tap the **Insurance** box, enter the amount, and tap **Apply**.

4. To confirm, tap **Apply**.
5. Place the envelope or envelopes on the feed deck. Depending on the SendPro C model you have, feed the envelopes manually or tap **Start** to feed the envelopes.

Printing a custom or standard graphic

Customise your mail by adding a custom logo or standard graphic.

Uploading Custom graphics

You can upload a graphic via Your Account. [Sign in](#) to the Pitney Bowes Your Account online portal.

Downloading Custom Graphics

Tap **SendPro Apps** on the Home screen, then tap **Rates and Updates**. Your graphic downloads will then be available for printing.

Standard graphics

Your device has a set of standard graphic images that you can add when you print postage.

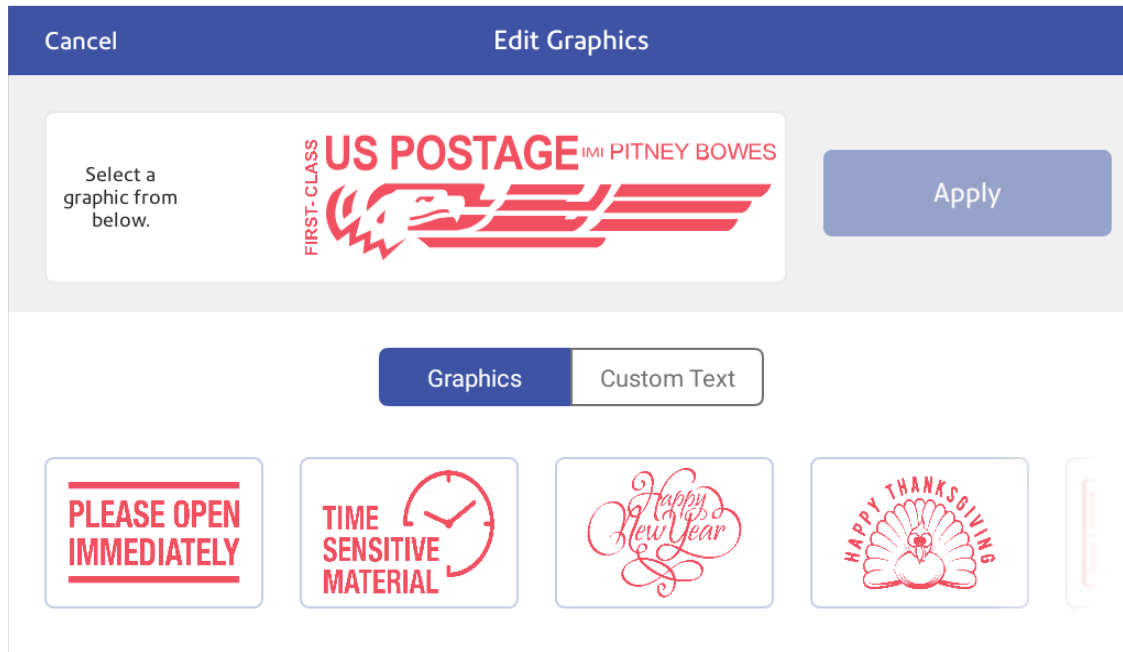

Printing a custom or standard graphic

1. Tap **Print on Envelopes** on the Home screen.
2. Tap **Account** and select an account if accounting is enabled on your device.

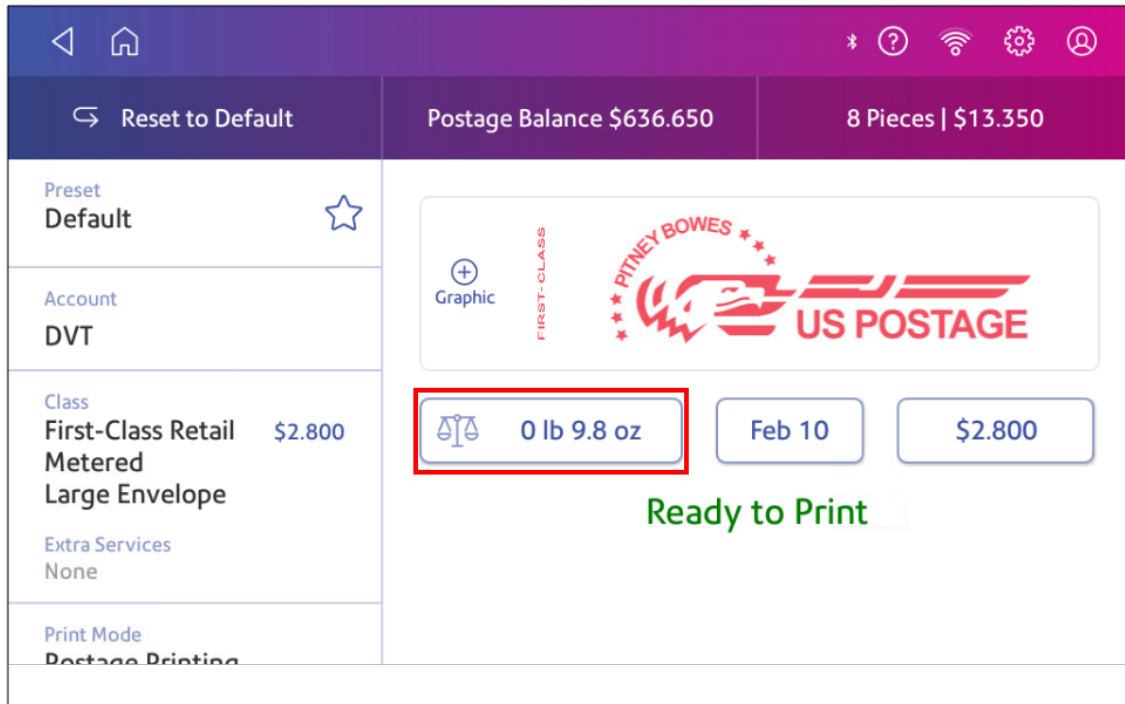
3. Tap **Weight**.

4. Tap **Scale**.
5. Place the envelope on the scale. You must do this before the next step or else the **Apply** button remains inactive.
6. Tap **Class** then select the class of mail you want.

7. Tap **Graphic**.

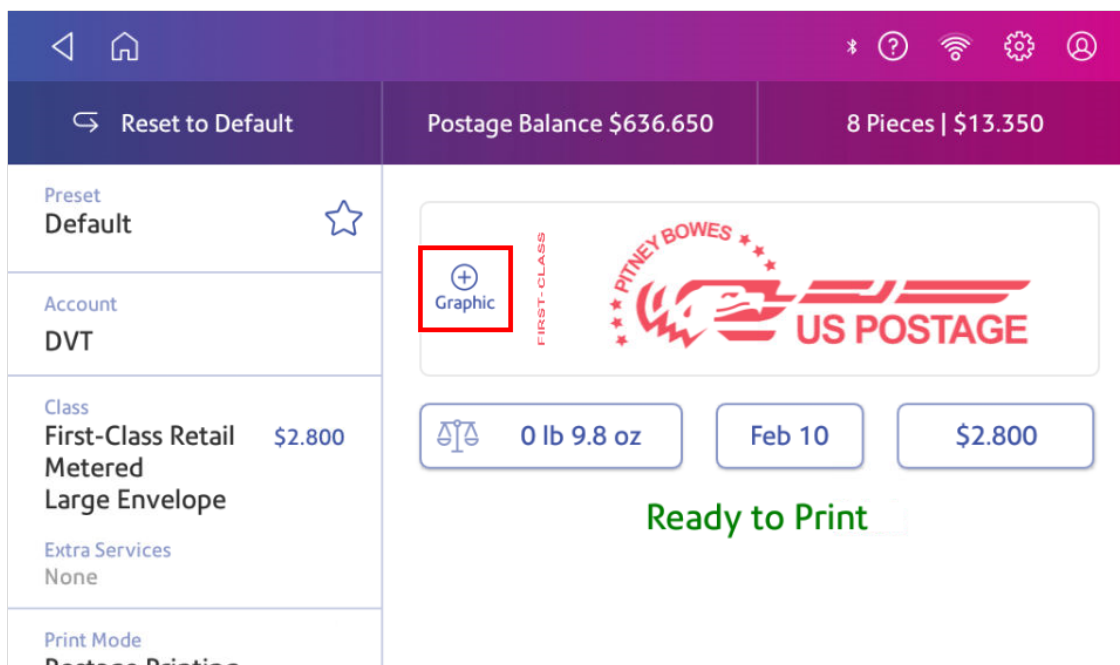

8. Select the graphic you want from the list.
9. Tap **Apply**.
10. Place the envelope on the feed deck. Depending on the SendPro C model you have, feed the envelopes manually or tap **Start** to verify that the envelope prints correctly.

Sending mail using Electronic Return Receipt (ERR)

Tracking services are available when you use the scale or Manual Weight entry method. The following steps are based on using Priority class and the Electronic Certified service with Electronic Return Receipt (ERR).

In order to use ERR, you must submit Form 5053, Bulk Proof of Delivery to the USPS. The USPS then provide you with a 9-digit USPS Mailer ID. You need to enter this number when using ERR. The following procedure is an example of how to use ERR.

1. Tap **Print on Envelopes** on the Home screen.
2. Place the envelope or package on the scale.
3. Tap **Class**. If **Priority Mail Retail** is not the current class, tap **Start Over**, then select **Priority Mail Retail** from the list of classes.

4. Tap **Envelope or Package**.
5. Enter the ZIP Code, then tap **Apply**.
6. Tap the **Electronic Certified** box.
7. Tap the **Electronic Return Receipt** box.
8. Tap **Apply**.
9. Enter the barcode number from your USPS PS Form 3800 using the keypad or use the optional barcode scanner. The barcode number should start with a 94.
10. (Optional) Add your Customer Reference Number. Tap **Apply** to confirm.
11. When prompted to apply the barcode label on the envelope, tap **Continue**. The barcode appears in the Class section of the screen.
12. Place the envelope or envelopes on the feed deck. Depending on the SendPro C model you have, feed the envelopes manually or tap **Start** to feed the envelopes.

Getting a USPS refund for damaged or incorrectly printed mail

Once you print an impression, your device deducts the postage amount from the postage funds. This happens even if the printing is illegible. Therefore, it is important to:

- Ensure that the correct value appears before printing postage.
- Ensure that the ink level does not get too low. **Recommended:** Always have a spare ink cartridge available.

For up-to-date refund guidelines, refer to the FAQ page of the USPS website.

Postage device indicia is eligible for a refund if it is complete, legible, valid, unused and printed on un-mailed envelopes, wrappers, or labels made in accordance with USPS DMM 604.9.3.4. This includes:

- Postage printed on the back (versus the front) of a letter
- Only a portion of the postage printed, or postage is not legible
- Too much postage was printed on the item
- Not enough postage was printed on the item
- Incorrect date on the device
- Incorrect information (street name, street number, city, etc.)

Your refund request must include:

Printing on envelopes

- a completed USPS Form 3533
- proof that the person requesting a refund is an authorized user of the device
- unused meter indicia

You must submit your refund request within 60 days from the date shown on the mail to your local Post Office.

For all indicia except those produced by PC Postage systems, you must submit the indicia to the licensing Post Office.

- The Postal Service™ refunds 90% of the face value on the indicia if the total is \$500 or less.
- If the total face value is more than \$500, the charge is \$50 per hour for the actual hours to process the refund, with a minimum charge of \$50.

Creating a custom text message for your mail

You can create a custom text message for your mailpiece. The message can be up to 5 lines with each line containing a maximum of 20 characters. You can leave any of the 5 lines blank. The message is centered on the envelope or tape when you print postage.

1. Tap **Print on Envelopes** on the Home screen.
2. Tap **Print Mode**.
3. Tap **Graphic Only**.
4. Tap **Apply**.
5. Tap **+ Graphic**.

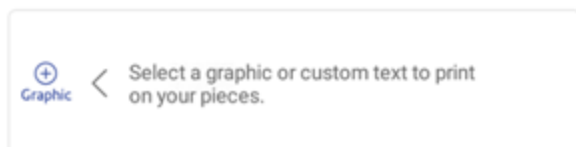

6. Tap **Custom Text**.

7. Tap **+ Add**.

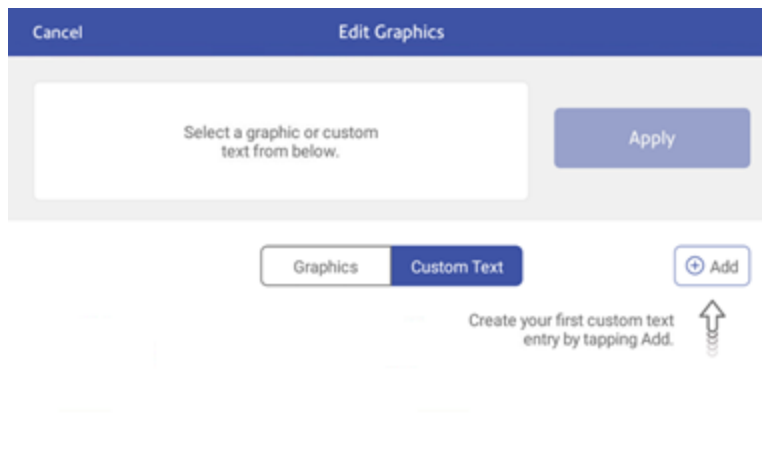

8. When creating a message, a message appears to inform you that you must comply with Postal rules. Tap **Accept & Continue** to agree.
9. Enter a name for the text message, then tap **Save**

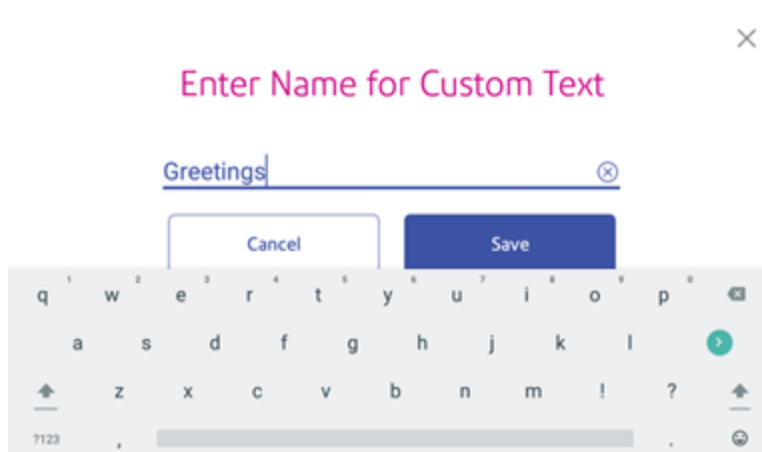

10. Enter the text on any or all the lines, with a maximum of 20 characters per line.

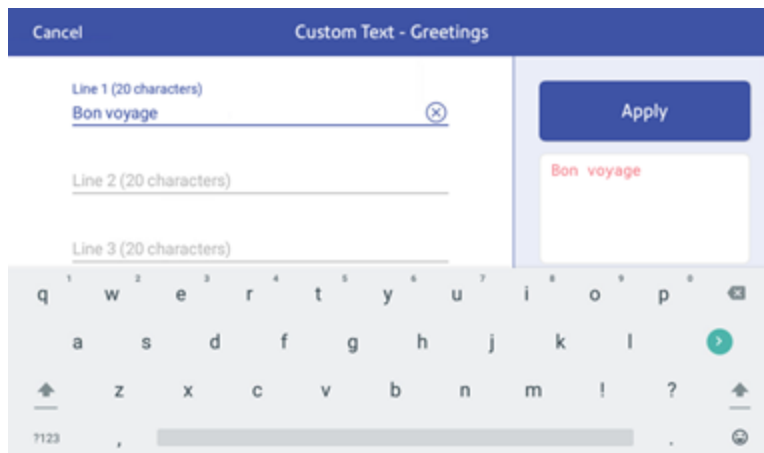

11. When finished, tap **Apply**. The screen displays the message as it will appear on your envelope or tape.
12. Tap **Apply** again. The custom text message is now available when you print postage.
13. Tap the back arrow to return to the Home screen.

Adding a custom text message to your envelope or tape

Your SendPro C Lite, SendPro C, SendPro+ allows you to add a custom text message to your mail. This can be a return address, for example. Your message can be up to five lines, with 20 characters per line. The message prints on the left side of the print.

1. Tap **Print on Envelopes** on the Home screen.
2. Weigh your envelope, select a class and special services, if required.

3. Tap + Graphics.

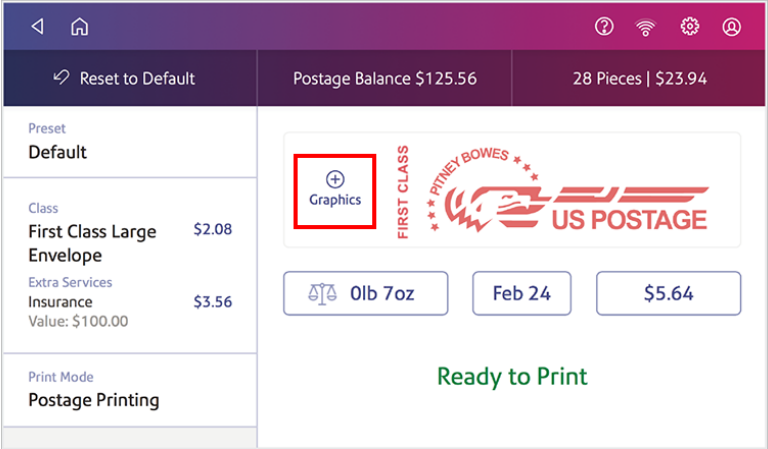

4. Tap Custom Text.

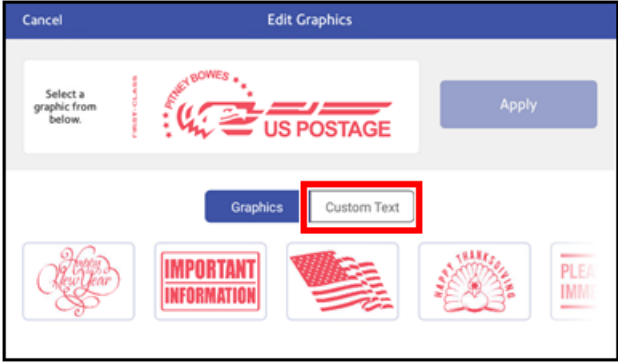

5. Tap on the text message you wish to use. A green check mark appears next to the selected message.



6. Tap **Apply**. The custom text message appears on a preview screen.

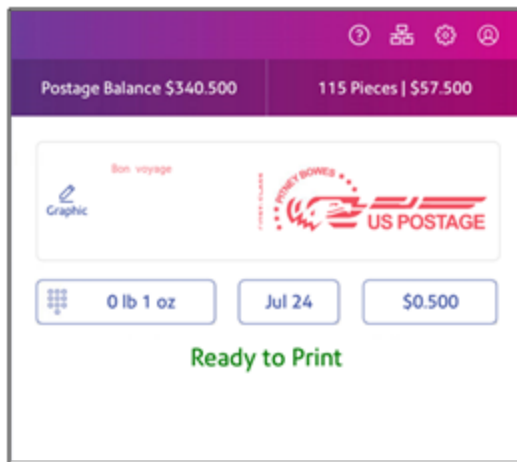

7. Feed the envelope or tape strip through the device.

Editing or deleting a custom text message

Your device allows you to add a custom text message to your mail. You can edit or delete messages you no longer need.

1. Tap **Print on Envelopes** on the Home screen.
2. Tap **+ Graphics** on the Print on Envelopes screen.

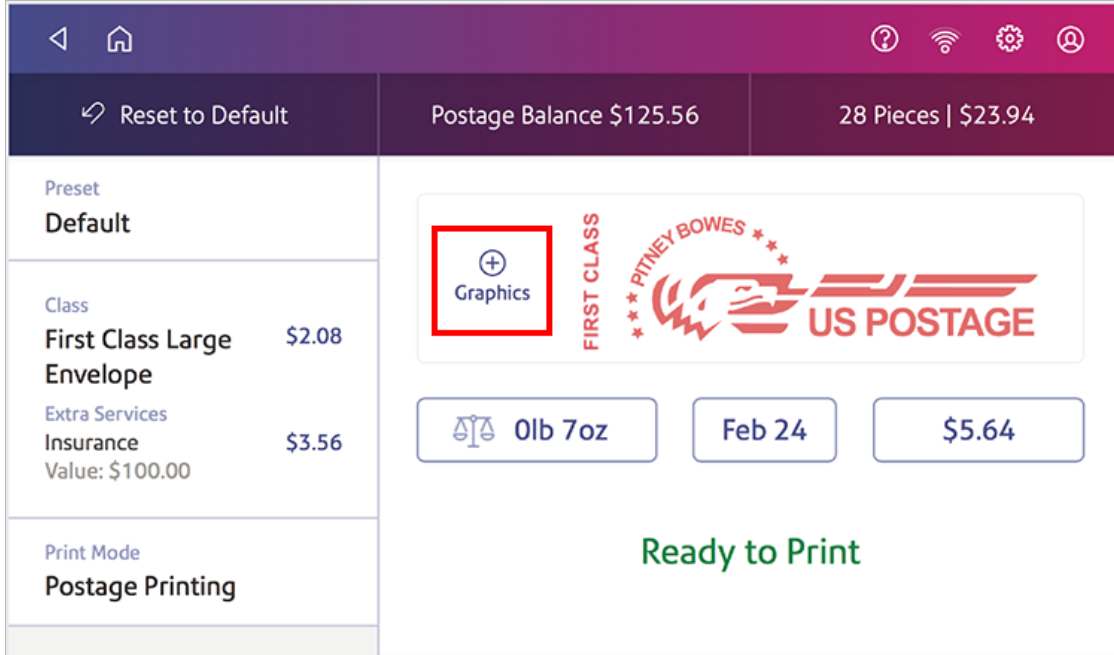

3. Tap **Custom Text**.

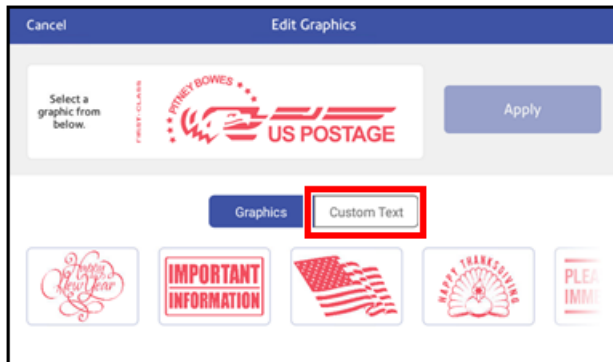

4. Tap on the custom message you wish to edit or delete, then tap **Edit**.

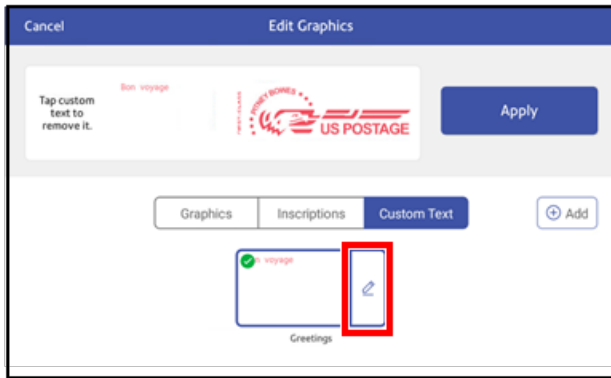

5. Select the appropriate option. You can edit the text message, rename it, or delete it.

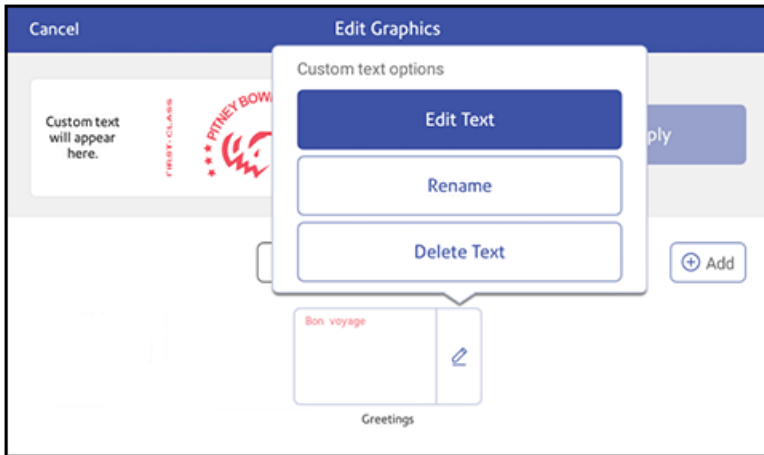

6. Tap **Apply**.

Printing a graphic without printing postage

Print a graphic without printing postage, such as the Received graphic on incoming mail.

1. Tap **Print on Envelopes** on the Home screen.
2. Tap **Print Mode**.
3. Select **Graphic Only**.
4. Tap **Apply**.
5. Tap **Graphic**.

6. Tap **Graphics**, then select your graphic.
7. Confirm with **Apply**.
8. Print the graphic on the envelope or tape.

Adding an inscription

Inscriptions appear automatically when you select certain classes of mail. This saves you time and helps you always use the correct inscription.

For example, if you select First Class mail, the First Class inscription prints automatically on your mail.

Printing only the date and time

Print the date and time to keep a record of when you receive incoming mail.

Printing on envelopes

1. Tap **Print on Envelopes** on the Home screen.
2. Tap **Print Mode** (you may have to scroll down to see this).

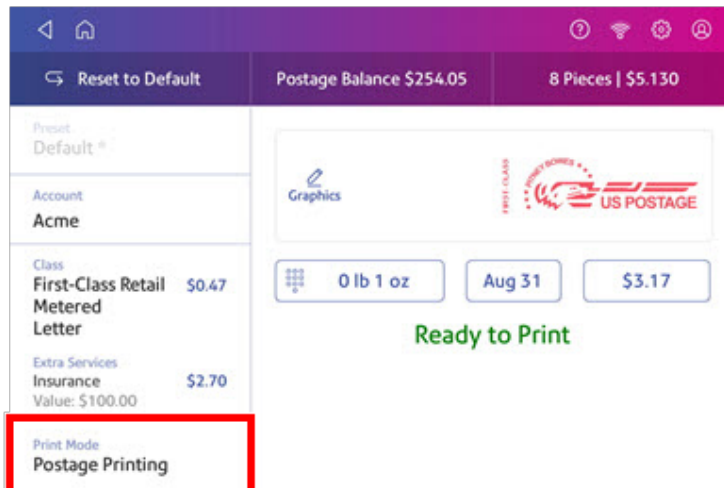

3. Select **Date and Time Stamp**.
4. Tap **Apply**.
5. Place the envelope or envelopes on the feed deck. Depending on the SendPro C model you have, feed the envelopes manually or tap **Start** to feed the envelopes.

Setting the right margin adjustment

Set the right margin adjustment to move the print further away from the right side of your envelopes. This can be helpful when printing thick mail.

1. Tap **Settings**.



2. Tap **Right Margin Adjustment**.
3. Select the desired measurement up to 16 mm. The default setting is 0.

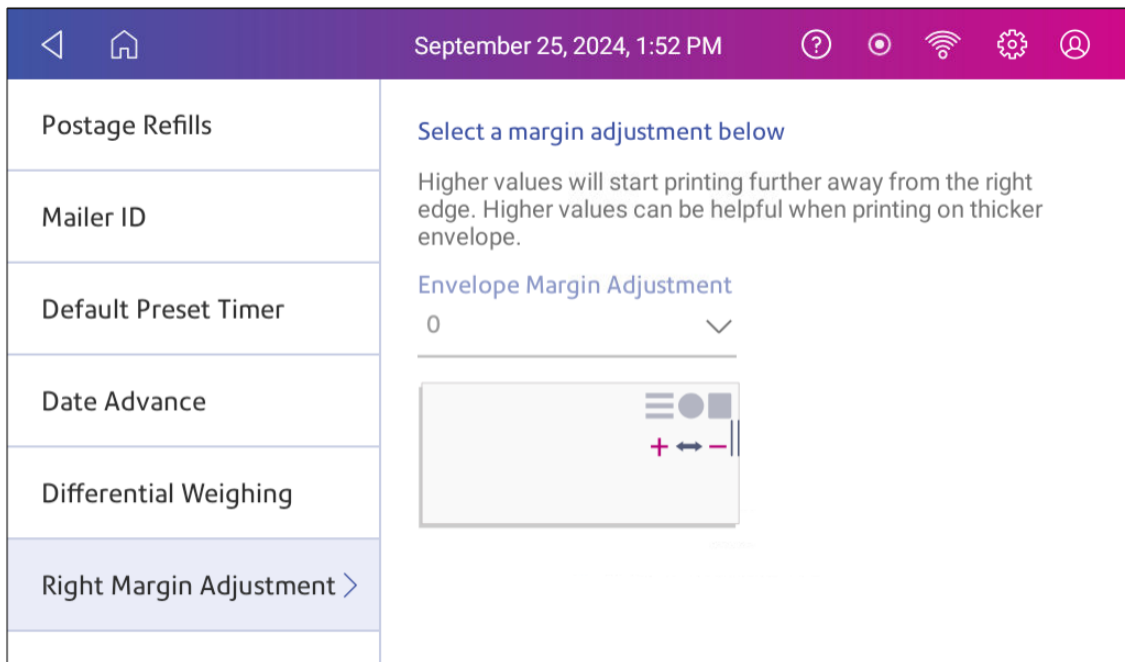

4. Tap **Home** to return to the Home screen.

5 - Managing Printing on Envelopes

In this section

Confirming your meter update.....	90
Changing the default refill amount for printing postage.....	90
Uploading postage transactions.....	91
Clearing or resetting the number of mailpieces sent.....	92
Updating postal rates or software for printing on envelopes.....	92
Confirm the effective date for postal rates.....	93
Setting the low funds warning for printing postage.....	94
Setting up a mailer ID.....	94
Updating the ZIP code.....	94
What is Accounting.....	95
Turning Print on Envelopes account passwords on or off for printing postage.....	96
Adding a Print on Envelopes account.....	97
Editing an account.....	98
Making an account inactive.....	98
Deleting an account.....	99
Creating presets for printing postage.....	99
Viewing presets for printing postage.....	100
Selecting a preset for printing postage.....	101
Modifying presets for printing postage.....	101
Setting the default preset timer.....	101

Confirming your meter update

To check if you have the latest rates for Print on Envelopes:

1. Locate your Product Code Number (PCN) and 7-digit serial number.
2. Go to the [Confirm your meter update](#) web page.
3. Select your PCN from the menu and enter the serial number in the field provided.
4. Click **Confirm Meter Update**.

Changing the default refill amount for printing postage

Change the default refill amount to store an amount you want to refill your device with.

You can set the default refill amount during installation or change it at later time.

There are two ways to change the default refill amount:

From the Home Screen:

1. Tap **Settings**.



2. Scroll down to the Envelope Printer Settings section.
3. Tap **Postage Refills**.
4. Tap the box under **Default refill amount**.
5. Tap the back key to remove the existing amount. You may need to tap the key multiple times to clear the amount.
6. Enter the new amount.
7. Tap **Apply**.
8. Tap the back arrow to return to the Home screen.

From Print on Envelopes:

1. Tap **Print on Envelopes** from the Home screen.
2. Tap **Postage Balance**.
3. Tap **Refill Settings**.
4. Tap the box under **Default refill amount**.

5. Tap the back key to remove the existing amount. You may need to tap the key multiple times to clear the amount.
6. Enter the new amount.
7. Tap **Apply**.
8. If necessary, tap the back arrow to return to the Print on Envelopes app.

Uploading postage transactions

Automatic upload of your postage transactions

- Your device automatically uploads your postage transactions to the Pitney Bowes Data Center. This occurs at least once during the day and once after hours.
- If you lock your device or turn it off for any extended period, it automatically uploads your transactions when you turn it on again.
- If you see the message "Sync Transaction Data" or "Sync USPS Transaction Data", it means you need to upload your transactions.

Important: If your device had connection issues recently, it may require multiple uploads to upload transactions. If the device prompts you to upload more than three times, please contact technical support.

Manual upload of your postage transactions

1. Tap **Settings**.



2. Scroll down to the Envelope Printer Settings section.
3. Tap **Sync Transaction Data** or **Sync USPS Transaction Data**.
 - A series of messages appear, starting with "Preparing Transaction Data" followed by "Sending Transaction Data."
 - Once the upload is complete, the message "Transaction Data Sent" appears.
 - The message "No Sync Required" appears if there are no new transactions to upload.

Clearing or resetting the number of mailpieces sent

Reset the piece counter to delete the piece count information.

Make certain that you wish to delete the piece count information. Once you do so, you cannot restore the deleted data.

1. Tap **Print on Envelopes** on the Home screen.
2. Tap **Pieces**.
3. Tap **Reset Counter to 0**.

Updating postal rates or software for printing on envelopes

Automatic updates

Your device updates postal rates and software automatically.

Keep your device turned on and connected to your network to get your automatic updates, as the device downloads updates during the evening hours.

Manual postal rate updates

1. Select Rates and Updates:
 - Tap **SendPro Apps**, then **Rates and Updates**.
2. If new rates are available, your device downloads and installs updates.
 - a. If the rates are available today, this message appears:
"New postage rates took effect today. Your device has been updated and new rates are already in effect. To learn more, visit pitneybowes.com/ratesandupdates."
 - b. If the rates took effect already, this message appears:
"New postage rates took effect on [effective date]. Your device has been updated and new rates are already in effect. To learn more, visit pitneybowes.com/ratesandupdates."
 - c. If the new rates are pending, this message appears:
"New postage rates take effect on [future effective date]. Your device has been updated and you'll see the new rates then. To learn more, visit pitneybowes.com/ratesandupdates."
3. To continue tap **Got it**.

Manual software updates

1. Select Rates and Updates:
 - Tap **SendPro Apps**, then **Rates and Updates**.
2. If new rates are available, your device downloads and installs updates.
 - a. If the rates are available today, this message appears:
"New postage rates took effect today. Your device has been updated and new rates are already in effect. To learn more, visit pitneybowes.com/ratesandupdates."
 - b. If the rates took effect already, this message appears:
"New postage rates took effect on [effective date]. Your device has been updated and new rates are already in effect. To learn more, visit pitneybowes.com/ratesandupdates."
 - c. If the new rates are pending, this message appears:
"New postage rates take effect on [future effective date]. Your device has been updated and you'll see the new rates then. To learn more, visit pitneybowes.com/ratesandupdates."
3. To continue tap **Got it**.

Confirm the effective date for postal rates

You can check to see if you have downloaded the latest rates for each postal class on your device.

1. Tap **Print on Envelopes**.
2. Tap **Class**.
3. Tap **Start Over** to display a list of all the available classes.
4. Tap the information icon (i) next to the class you wish to check, for example First-Class Retail Metered. The rate change information appears for the class.

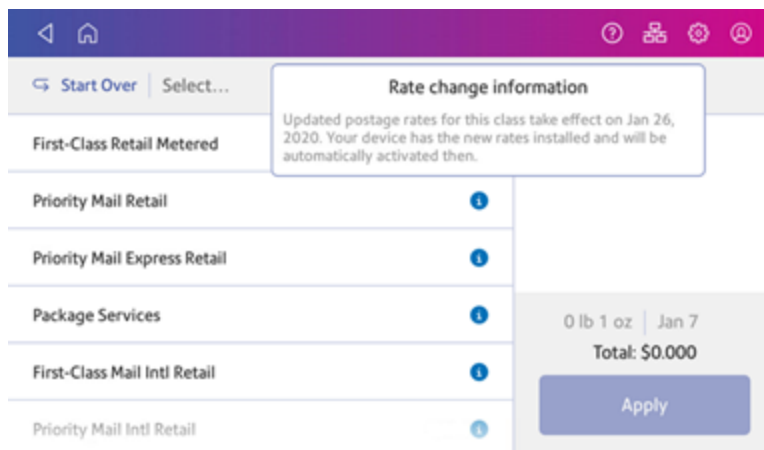

Setting the low funds warning for printing postage

Set the low funds warning to warn you when your available funds for printing postage reaches a certain amount. Use this warning as a reminder to add more postage to your device.

1. Tap **Print on Envelopes** on the Home screen.
2. Tap **Postage Balance**.
3. Tap **Refill Settings**.
4. Tap **Low postage threshold**.
5. Tap **back** on the keypad to remove the existing amount.
6. Enter the new amount.
7. Tap **Apply**.
8. If necessary, tap the back arrow to return to the Print on Envelopes app.

Setting up a mailer ID

Your mailer ID is a 9-digit number that you need when using Electronic Return Receipt (ERR). To get your mailer ID, submit Form 5053, Bulk Proof of Delivery to the USPS.

1. Tap **Settings**.



2. Scroll down to the Envelope Printer Settings section.
3. Tap **Postage Refills**.
4. Tap **Mailer ID**.
5. Enter the 9-digit number using the keypad.
6. Tap **Apply**.

Updating the ZIP code

The ZIP code printed by your device should be either your ZIP code or the ZIP code of the post office picking up your mail.

If your device prints an incorrect ZIP code, a Pitney Bowes representative must resolve this issue. Contact technical support for assistance.

What is Accounting

You can use the accounting feature to track the postage that departments or individuals within your organization use.

The accounting feature helps you to understand how your business spends its postage and identify cost-saving opportunities. You can charge postage back to departments or clients and report on postage expenditures.

The Print on Envelopes app uses a multi-level account format.

When you use Print on Envelopes accounts to track your postage usage, use sub accounts and sub sub accounts to analyze your usage within an account.

How you create accounts depends on your needs. You can create accounts in single or multiple levels. For example, you can divide a top level department (account) into two additional sub sections (sub accounts and sub sub accounts).

The Print on Envelopes accounting structure can have up to a three level hierarchy:

- account (top level of the hierarchy)
- sub account (next possible level of the hierarchy)
- sub sub account (last possible level of the hierarchy)

Important: Only the lowest level of the account hierarchy is chargeable. This means that the lowest level of the account has the transactions applied to them.

- **Account with no sub accounts** - When you create an account with no sub accounts, you charge postage to that account. This is because the account does not have sub or sub sub accounts.
- **Account with sub account or sub sub account** - When you create a sub account or sub sub account, you charge postage to the lowest level (the sub account or sub sub account).

Account hierarchy examples

Top level account

- Engineering

Account with sub accounts

- Engineering; Sub account - Software;
- Engineering; Sub account - Hardware;

Account with sub sub accounts

- Engineering; Sub account - Software; Sub sub account - Graphics and Layout; Sub sub account - Design
- Engineering; Sub account - Hardware; Sub sub account - Quality Approval; Sub sub account - Testing

Turning Print on Envelopes account passwords on or off for printing postage

You can protect each account from unauthorized access by turning account passwords on.

1. Tap **Print on Envelopes** on the Home screen.
2. Tap **Account**.
3. Tap **Preferences**.



4. Tap **Manage Accounts**.

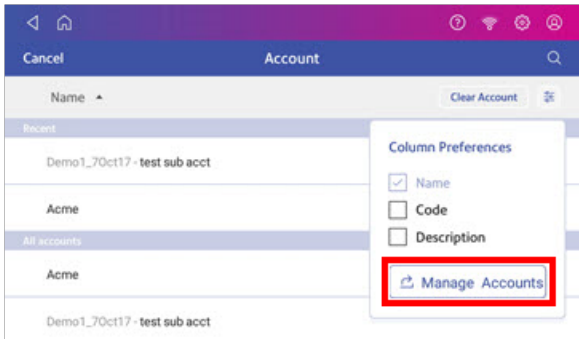

5. The Manage Accounts screen opens.

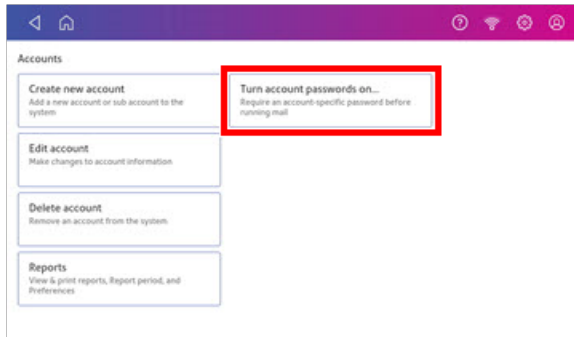

- Tap **Turn account passwords on** if account passwords are off and you wish to turn them on. Tap **OK**.
 - Tap **Turn account passwords off** if account passwords are on and you wish to turn them off. Tap **OK**.
6. Tap the back arrow on the top left side of the screen to return to the list of accounts.
 7. Tap **Cancel** to return to the Mail screen.

Adding a Print on Envelopes account

You can add a Print on Envelopes account to track your costs for printing postage on envelopes.

Accounting is a feature that is optional and needs enabling if you want to use it. Contact your Pitney Bowes Sales Representative for information about options and pricing.

1. Tap **SendPro Apps** on the Home screen.
2. Tap **Manage Accounts**.
3. Tap **Create new account**.
4. Tap **Create a new account** for a new account.
5. Enter the account name in the Enter account name field. Account names can be up to 75 characters long.
If the keyboard does not pop up, tap the line in the gray box.
6. Enter a unique code in the Code field to identify each account. Codes can be alphanumeric. Codes help you locate accounts more easily.

7. You can use the optional fields, such as:
 - **Description** - Enter a description of the account up to 150 characters.
 - **Password** - Tap **Password** to add a password for an account.
 - Passwords are case sensitive, can be alphanumeric, and must be four characters in length. If you do set a password, you need to enter it to print mail.
8. Ensure you set the status to active.
9. Tap anywhere on the screen outside of the fields when complete.
10. Tap **OK** to save. The name of the new account appears.
 - Tap **Create New Account** to create another account.
 - Tap **Add a Sub Account to this account** to add a sub account to the account you just created.
 - Tap **Done** if you do not need to create any more accounts.
11. Press the **back arrow** to return to the account list.

Editing an account

Edit an account when you want to change the account name, code, description, status or password.

Important: Once you charge postage to an account, you cannot change the account name or code.

1. Tap **SendPro Apps** on the Home screen.
2. Tap **Manage Accounts**.
3. Tap **Edit account**.
4. Tap the account you want to edit.
5. Select **OK**.
6. Make your changes, such as edit the account name, code, description, status or password.
7. When finished, tap anywhere on the screen outside of the fields.
8. Tap **OK** to return to the Accounts screen.
9. Tap the back arrow to return to the list of accounts.
10. Tap **Cancel** to return to the Print on Envelopes screen.

Making an account inactive

Setting the account status to inactive prevents anyone from charging postage against an account.

1. Tap **SendPro Apps** on the Home screen.
2. Tap **Manage Accounts**.
3. Tap **Edit account**.
4. Tap the account you want to make inactive.
5. Select **OK**.
6. Tap the **Inactive** button.
7. Tap **OK** to return to the Accounts screen.
8. Tap the **back arrow** to return to the SendPro Apps screen.
9. Tap **Close** to return to the Home screen.

Deleting an account

If you apply postage to an account, you cannot delete the account. You can only make the account inactive.

Make sure you do not need an account's data before you delete an account. When you delete an account, sub account or sub sub account, you delete its data. You cannot recover that data.

1. Tap **SendPro Apps** on the Home screen.
2. Tap **Manage Accounts**.
3. Tap **Delete account**. The list of available accounts appears.
4. Tap the account you want to delete.
5. Tap **OK**.
6. Tap **Yes, delete account** to confirm.
7. Tap **OK**.
8. Tap the back arrow to return to the SendPro Apps screen.
9. Tap **Close** to return to the Home screen.

Creating presets for printing postage

Create presets to store a group of commonly-used settings. Presets can store settings such as a postage class, an account and a graphic. The maximum number of presets you can have is 21. This includes the default preset.

1. Tap **Print on Envelopes** on the Home screen.
2. Tap **Class**, select the class and any special services, messages or graphics.

3. Verify the settings in the Print on Envelopes app.
4. Tap the **star** in the Preset box.
Important: You must modify something in the Print on Envelopes app for the Preset star to appear.

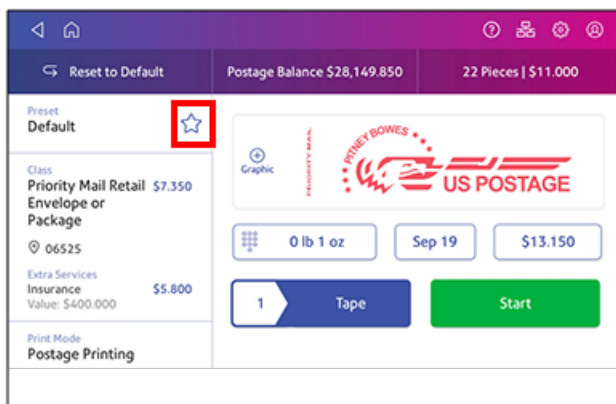

5. Tap **Save New Preset** to save it. If you wish to save it and replace the default setting, tap **Replace Default Preset**.

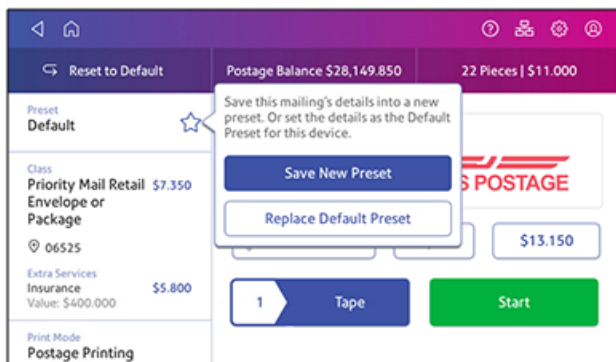

6. For a new preset, enter a name, then tap **Save**.

Viewing presets for printing postage

1. To view the presets, tap the **Preset** box on the Print on Envelopes screen.
2. Tap each preset to view its settings.

Selecting a preset for printing postage

Select a preset to quickly apply a group of settings.

1. Tap **Print on Envelopes** on the Home screen.
2. Tap **Preset**.
3. Tap the preset you want to use, then tap **Apply Preset**.

If you select a preset and do not use it within about one minute, the Print on Envelopes screen restores the default preset values. The same is true when you switch your device off or it enters sleep mode.

Modifying presets for printing postage

Modify a preset to rename a preset, replace the default preset or delete a preset.

1. Tap **Print on Envelopes** on the Home screen.
2. Tap **Preset**.
3. Tap the preset you wish to modify.
4. Tap **Options**.

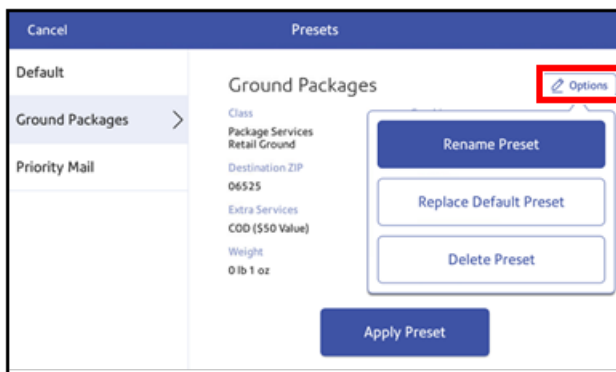

5. Tap the option you want.

Setting the default preset timer

The default preset timer will reset your device to your most commonly-used settings. By default, the preset timer resets your device after one minute of inactivity. You can change this time if necessary.

1. Tap **Settings**.



- 2. Scroll down to the Envelope Printer Settings section.
- 3. Tap **Postage Refills**.
- 4. Tap **Default Preset Timer**.
- 5. Use the slider to set the time between 1 and 9 minutes.

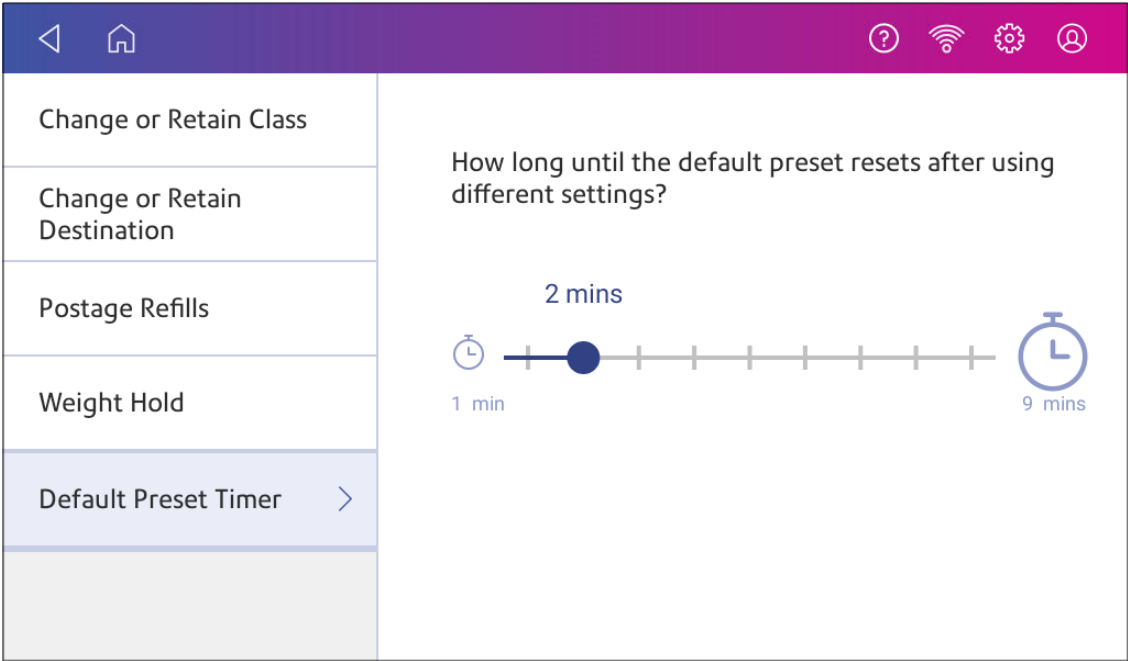

6. To save the value and exit the screen, tap the **back arrow** or **Home**.

6 - View and Print Reports

In this section

Viewing a receipt when refilling postage.....	104
Viewing the total spent on printing postage.....	104
Viewing the refill history for printing postage.....	104
Printing a funds report.....	104
Running account reports.....	105
Emailing an account report.....	106
Setting the report period for an account.....	107
Setting the account report preferences.....	108
Printing a scale report.....	109

Viewing a receipt when refilling postage

Use the Print Refill Receipt app to view receipts of previous postage refills.

- Tap **SendPro Apps** on the Home screen, then tap **Print Refill Receipt**.

Viewing the total spent on printing postage

View the total amount you have spent on postage and the total number of pieces printed.

1. Tap **Settings**.



2. Scroll down to the Envelope Printer Settings section.
3. Tap **Postage Refills**.
4. Tap **Advanced** to view the total amount of postage spent and the number of pieces printed.

Viewing the refill history for printing postage

View a report showing all your postage refill history.

1. Open the Refill History screen:
 - Tap **SendPro Apps** on the Home screen, then tap **Print Refill Receipt > Refill History**, or
 - Tap the **History & Reports** icon in the application drawer, then tap **Refill History**.
2. Tap on a postage refill to open a Refill Receipt.

Important: At this time, you can only view the report.

Printing a funds report

Print a funds report if you need a report showing the total number of mailpieces sent.

The funds report provides the following information about your device:

- **Used:** The total amount used over the lifetime of the device.
- **Available:** The amount currently available to print.
- **Total Pieces:** The total number of mailpieces run over the lifetime of the device.
- **Control Sum:** The control sum is the total of the amount used and available.
- **Batch Count:** The current Batch Count.
- **Batch Value:** The current Batch Total.
- **PBP Serial No:** The serial number of the device.
- The date and time the report was printed.

To print a funds report:

1. Tap **Print on Envelopes** on the Home screen.
2. Tap the piece count in the upper right.
3. Tap **Print Report**.
4. Tap **SendPro C Envelope Printer**.
5. Place the envelope on the feed deck. Depending on the SendPro C model you have, feed the envelope manually or tap **Start** to feed the envelope.
6. Tap the **back arrow** to return to the Print on Envelopes app.

Running account reports

Run account reports to show how you spent your postage for a specific account or for all accounts over various time periods.

1. Tap **SendPro Apps** on the Home screen.
2. Tap **Manage Accounts**.
3. Tap **Reports**.
4. If this is the first time you are running a report:
 - a. Tap **Report Period** and set the time range for your reports.
 - b. Tap **Preferences** and set how to you wish to identify the accounts.
5. Set the report period.
6. Tap **View & print reports**.
7. Tap to select a report.
8. Tap **Next**.

9. Choose what to do with the report:
 - To view the report on the screen, tap **View Report**.
 - Tap **Actions** to save the report under a new name, delete, print, or email the report. In order to print a report, you need an optional report printer.

Emailing an account report

Email an account report to keep a record of how much departments or clients have spent on their postage over specific time periods.

1. Tap **SendPro Apps** on the Home screen.
2. Tap **Manage Accounts**.
3. Tap **Reports**.
4. Tap **View & print reports**.
5. Tap the report to select it.
6. Tap **Next**.
7. Tap **Actions** or **View Reports** at the bottom of the screen.
8. Tap **Email Report**.

The screenshot shows a mobile application interface for viewing and printing reports. At the top, there is a purple header bar with navigation icons (back, home, help, menu, settings, profile). Below the header, the screen is divided into sections. The first section is labeled 'Period:' and contains a box with the text 'Current Period Start: 01-05-22 End: 31-05-22'. The second section is labeled 'Meter(PSD):' and contains a box with the text '1H20-8000018'. Below these sections, there are several action buttons: 'Save as', 'Save', 'Delete report', and 'Print report'. The 'Email Report' button is highlighted with a red border. At the bottom of the screen, there is a navigation bar with four buttons: 'Actions ▲', 'Cancel', 'Back', and 'View report'.

9. Tap in the **Please enter the recipient mail address** box and enter the recipient's email address. The email address you enter will remain until you turn off then turn on the device.

* Please enter the recipient mail address:

* Attach report as file type:

.xlsx

.csv

.pdf

* Required fields

Cancel Send

10. Tap the file type you wish to send: **xlsx** (Excel), **csv** (comma-separated values), **pdf** (Portable Data Format).
11. Tap **Send**. The report appears from no-reply@pb.com.

Setting the report period for an account

Set the reporting period of an account report by setting its start and end dates.

1. Tap **SendPro Apps** on the Home screen.
2. Tap **Manage Accounts**.
3. Tap **Reports**.
4. Tap **Report period**.

5. Select the calendar image next to the **Start date of fiscal year** field.

Report period defaults

Start date of fiscal year:
01.01.2023

End date of fiscal year:
31.12.2023

Default reporting period:
Calendar month

Calendar month periods for 2023:

Month 1	01.01.2023 to 31.01.2023
Month 2	01.02.2023 to 28.02.2023
Month 3	01.03.2023 to 31.03.2023
Month 4	01.04.2023 to 30.04.2023
Month 5	01.05.2023 to 31.05.2023

< Previous year Next year >

OK

- a. Select a date on the calendar.
 - b. Select **SET**.
- The End date of the fiscal year is set based on the start date you enter. You cannot enter this date manually.
6. Select the **Default reporting period** field.
 - a. Select a report period type.
 - b. Select **OK**.
 7. (Optional) Tap **Previous year** and **Next year** to view the reporting periods for the previous and next year. Tap **up** and **down** to scroll through the list of reporting periods for the current year.
 8. Tap **OK** to return to the Reports screen.

Setting the account report preferences

Set the account report preferences to select the account level you wish to report on (Account, Sub account or Sub sub account).

You can also choose how you want to identify accounts: by Name or by Code.

1. Tap **SendPro Apps** on the Home screen.
2. Tap **Manage Accounts**.
3. Tap **Reports**.
4. Tap **Preferences**.
5. Tap to select how you want to identify accounts: by **Name** or by **Code**.
6. Select the account level you wish to report on: **Account**, **Sub account** or **Sub sub account**.
7. Tap **OK** to return to the Reports screen.

Printing a scale report

Follow these steps to print a scale report.

1. Tap **Settings**.
2. Scroll down **Advanced Device Options** and tap **About this C-Series**.
3. Tap **Print Report**, then tap **Scale Report**.

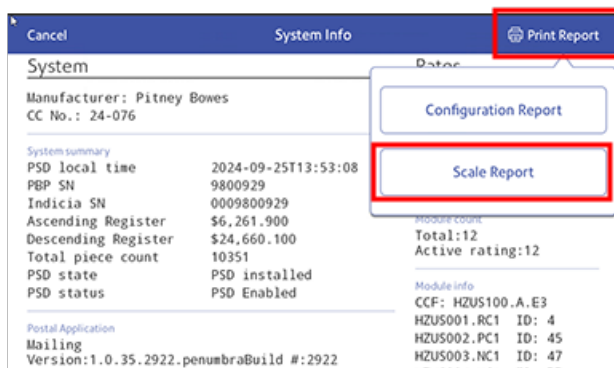

4. Insert an envelope or tape to print the report.

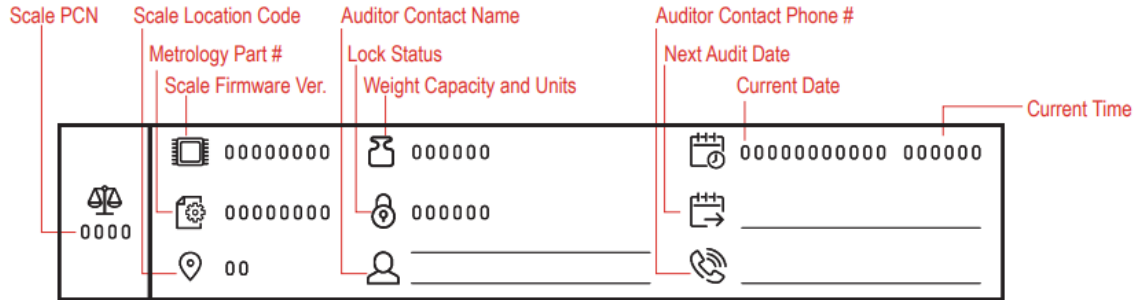
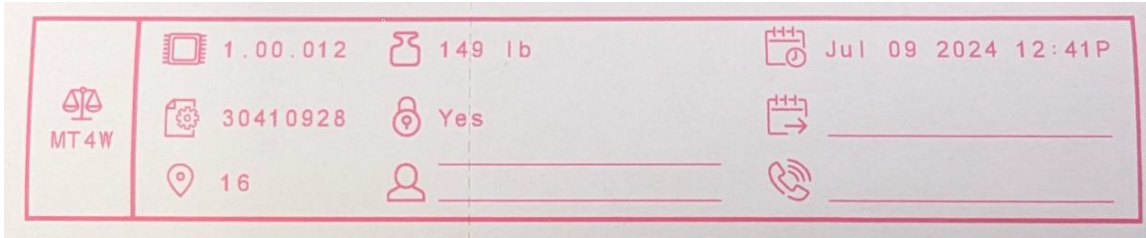

7 - Maintenance

In this section

Checking the postage print quality.....	112
Printing a test pattern.....	112
Checking the ink level.....	113
Replacing the ink cartridge.....	114
Changing the ink waste pad.....	116
Cleaning the printhead.....	118
Installing the printhead.....	123
Cleaning the moistener brush and wick assembly.....	128
Filling the moistener tank.....	132
Avoiding envelope sealing issues.....	133
Preventing envelope feeding problems.....	134
Moving the SendPro C Lite, SendPro C, SendPro+....	135

Checking the postage print quality

You can make a test print to check the quality of the postage printed on an envelope or tape strip.

1. Tap **Print on Envelopes** on the Home screen.
2. Tap **Print Mode**.
3. Scroll down and tap **Test Print**.
4. Tap **Apply**.
5. Feed an envelope or tape strip through the device.
6. Check the print quality.



Printing a test pattern

Print a test pattern to see if the printhead is working properly or if you have enough ink in the cartridge.

1. Tap **Settings**.



2. Scroll down and tap **Mail Printer Maintenance**.
3. Tap **Print Test Pattern**.
4. Insert the envelope into the device when the message "Print a Test Pattern?" appears.
5. Examine the pattern printed on the envelope:
 - Tap **Done** if the lines are unbroken and match the "Good" test pattern shown on the display.
 - Tap **Clean Print Nozzle** if the test pattern has missing or incomplete lines
 - Once the cleaning operation completes, you must print another test pattern.
 - If this new pattern still has broken or missing lines, you may need to replace the ink cartridge or clean or replace the printhead.
 - If you see no improvement in print quality, do not repeat the cleaning, as cleaning the print nozzles consumes ink.

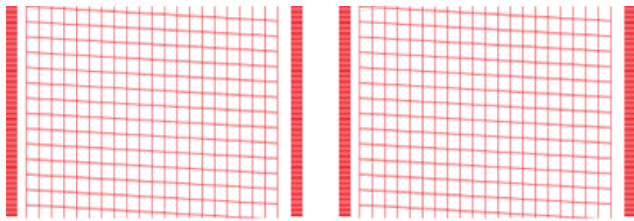

Good Test Pattern

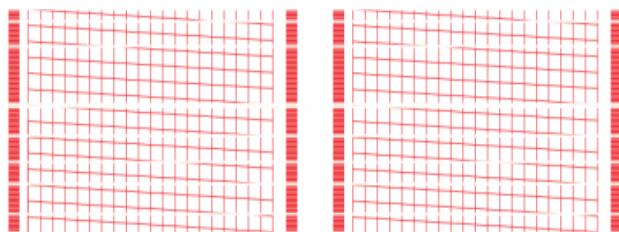

Bad Test Pattern

Checking the ink level

Check the ink level to ensure you have enough ink in your device.

1. Tap **Settings**.



2. Scroll down and tap **Envelope Printer Maintenance**.

3. View the level of remaining ink.

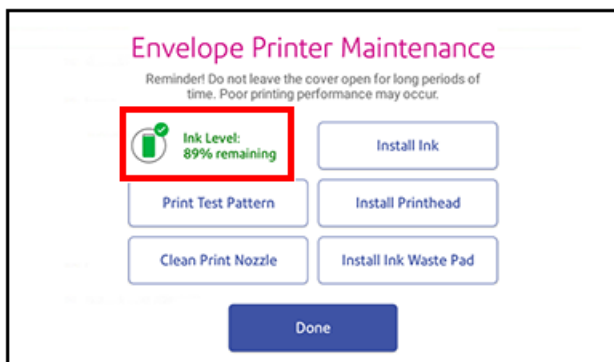

4. Tap **Done** to exit the screen.

Replacing the ink cartridge

Replace the ink cartridge when the low ink warning appears. This ensures your device is in optimal working condition.

1. Tap **Settings**.



2. Scroll down and tap **Mail Printer Maintenance**.
3. Tap **Install Ink**.
4. Lift the top cover. The ink cartridge moves to the front position.

5. Remove the ink cartridge, as shown on the label next to the cartridge holder.

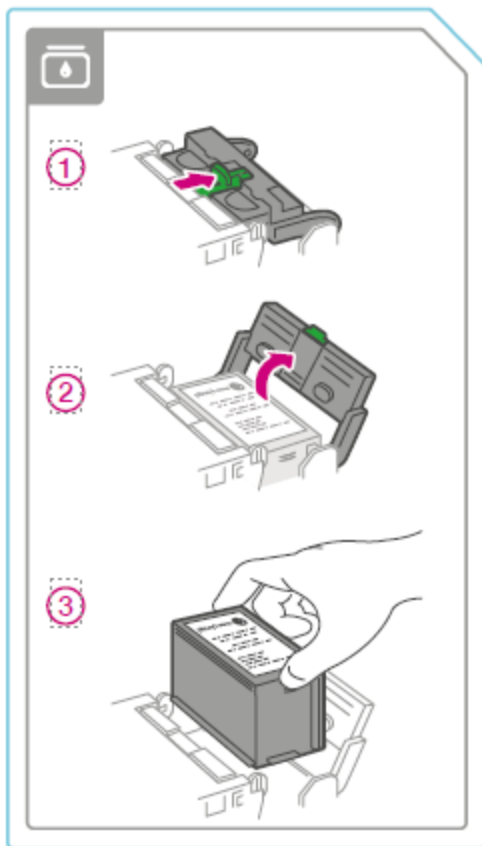

6. Insert the new ink cartridge, then close the ink cartridge guard.

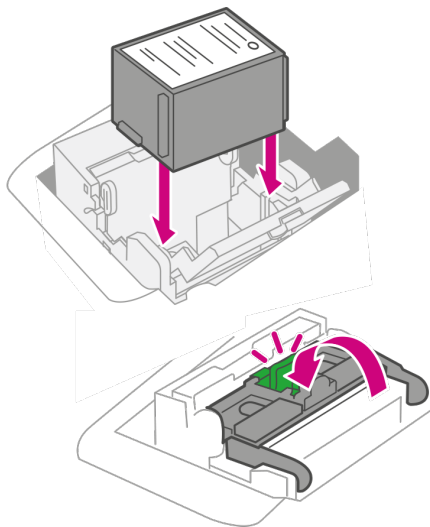

7. Close the top cover.

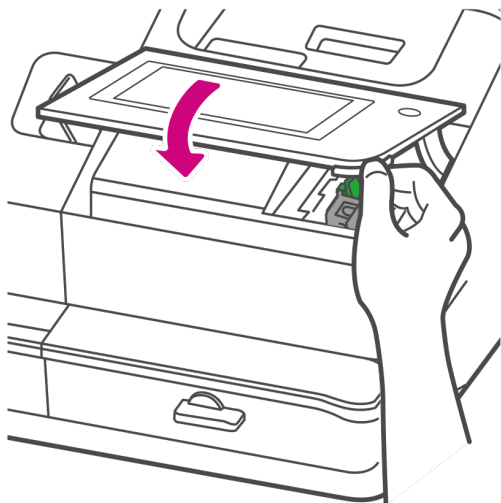

8. The cartridge repositions itself and the Mail Printer Maintenance screen appears.
9. Print a test pattern to ensure that your ink cartridge installs properly.

Changing the ink waste pad

Your device catches excess ink in a waste tank with a disposable pad. You will receive the following message at the top of the Print on Envelopes screen approximately 30 days before the ink waste tank becomes full:

"Ink waste pad is almost full. If you print often, replace it soon to avoid ink overflow."

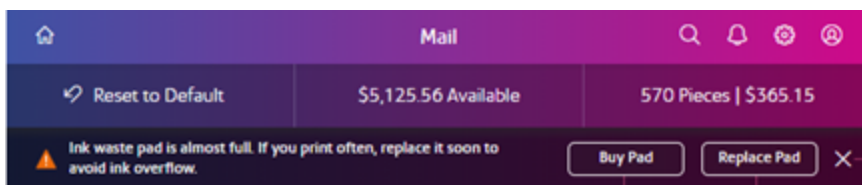

If the message is showing on the screen follow these steps:

To purchase replacement waste pad

Tap **Buy Pad**. The Supplies app appears where you can order a new pad right from the device.

To replace the pad

Before you replace the pad:

- Make sure you have a replacement waste pad available and you have the instruction sheet that comes with the pad. The sheet contains the reset code you will need in order to complete the replacement process.



1. Tap **Replace Pad**.
2. The instructions for replacing the existing pad display on the screen.
3. Follow the steps in each screen. To advance from one screen to the next, swipe to the left on the screen.
4. After you slide the waste tray with the new pad back in place, tap **Reset Ink Waste Counter** to continue.
5. Use the keypad to enter the reset code.
6. After you enter the code, the message "Your Ink Waste Pad is Ready to Use" displays. If you do not see this message, or if you still get a message that the waste tank is full, restart the device. If that fails to clear the message, contact Pitney Bowes support.

If the message no longer appears on the screen follow these steps:

If you need a replacement waste pad, use the Supplies app to purchase the pad.

To replace the pad:

1. Tap **Settings**.



2. Scroll down and tap **Envelope Printer Maintenance**.

3. Tap on **Install Ink Waste Pad**.

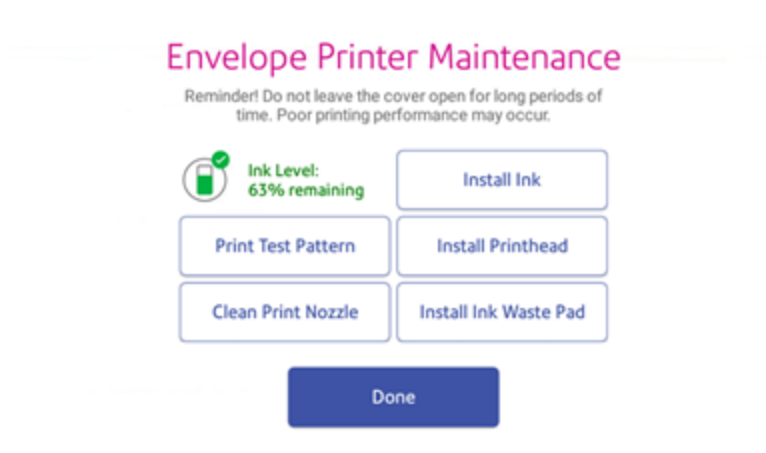

4. The instructions for replacing the existing pad display on the screen.
5. Follow the steps in each screen. To advance from one screen to the next, swipe to the left on the screen.
6. After you slide the waste tray with the new pad back in place, tap **Reset Ink Waste Counter** to continue.
7. Use the keypad to enter the reset code.
8. After you enter the code, the message "Your Ink Waste Pad is Ready to Use" displays. If you do not see this message, or if you still get a message that the waste tank is full, restart the device. If that fails to clear the message, contact Pitney Bowes support.

Cleaning the printhead

If you clean the print nozzle and you still get a bad test print pattern, try cleaning the printhead.

1. Tap **Settings**.



2. Scroll down and tap **Mail Printer Maintenance**.
3. Tap **Install Printhead**.
4. Lift the cover. The ink cartridge moves to the front position.

5. Flip the ink cartridge cover open.

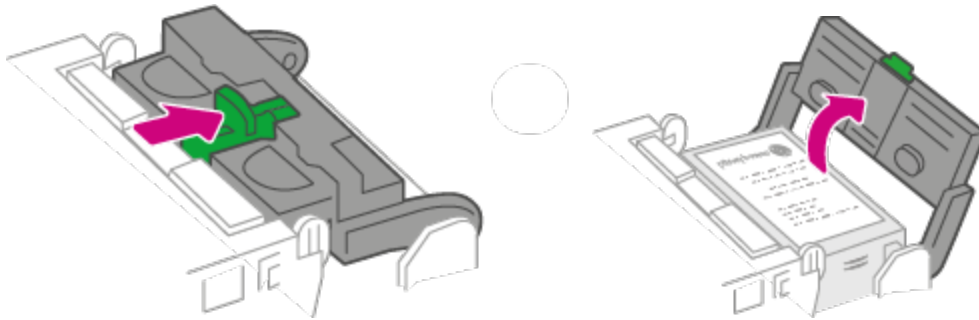

6. Remove the ink cartridge.

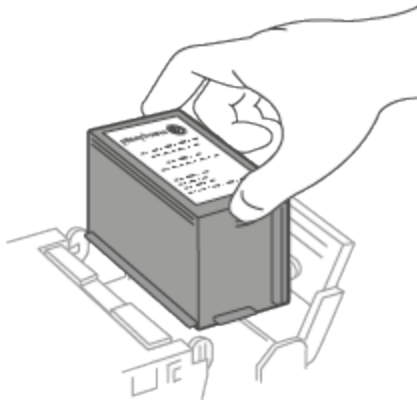

7. Squeeze the tabs on either side of the printhead.

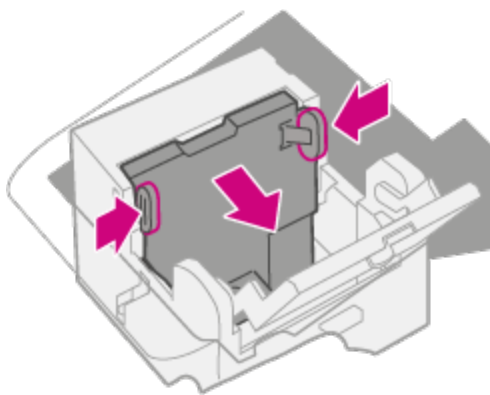

8. While squeezing, lift and tilt to the printhead to the right. The printhead should come up out of the device.

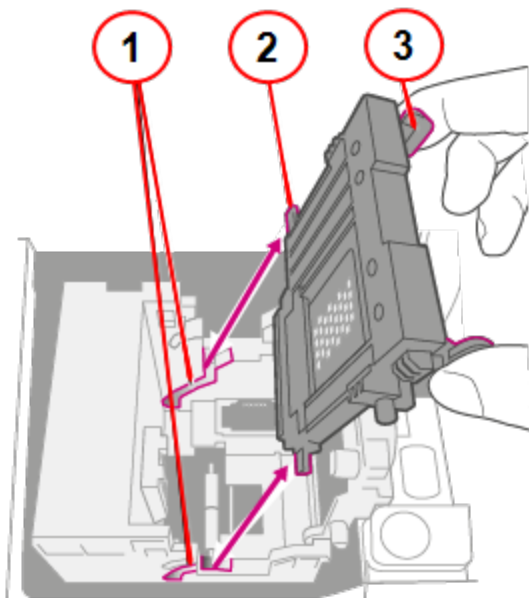

1. Grooves.
2. Peg.
3. Tab.

9. Clean off the printhead by wiping the surface of the printhead with a dry, lint-free cloth or a foam swab.

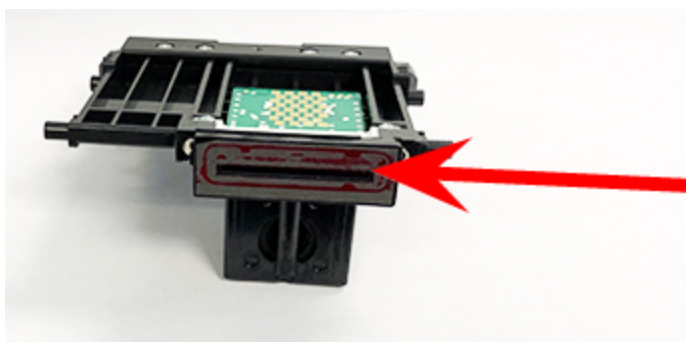

10. Squeeze the tabs and slide the printhead pegs into the lower set of grooves.

Warning: If you do not seat the printhead correctly it can damage the device.

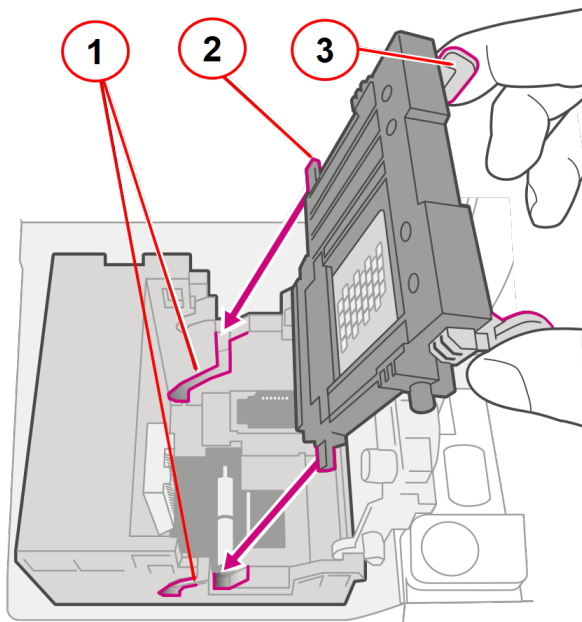

1. Grooves.
2. Peg.
3. Tab.

11. Keep squeezing the tabs and push the printhead flush against the wall. The tabs snap outward when placed correctly.

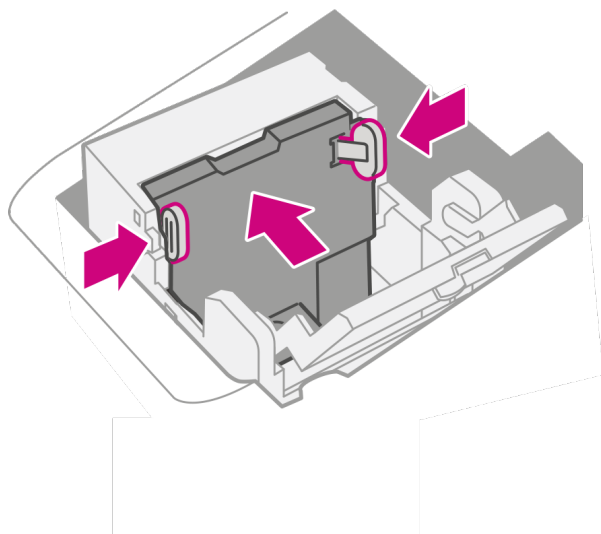

12. Install the ink cartridge and close the guard.

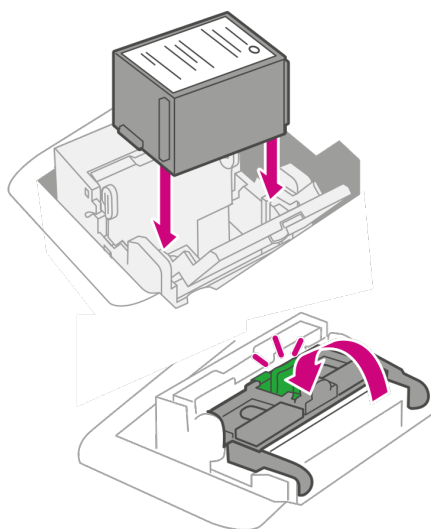

13. Close the cover. The ink cartridge moves back to the original position.

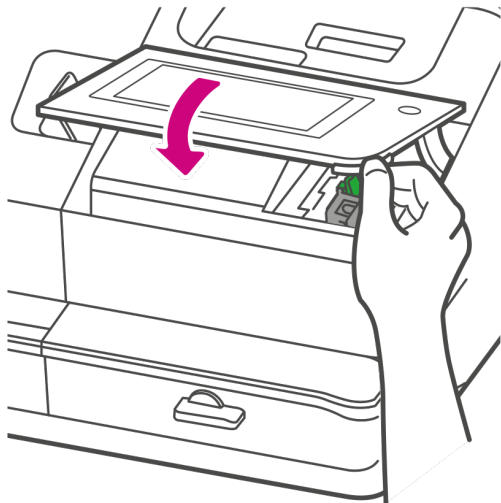

14. Tap **Done**.
15. Print a print test pattern to be sure that your printhead is functioning properly.
16. If the test pattern looks good, tap **Done**.

Installing the printhead

You may need to install a new printhead when the existing printhead is producing poor print quality.

1. Tap **Settings**.



2. Scroll down and tap **Envelope Printer Maintenance**.
3. Tap **Install Printhead**.
4. Lift the cover. The ink cartridge moves to the front position.

5. Flip the ink cartridge cover open.

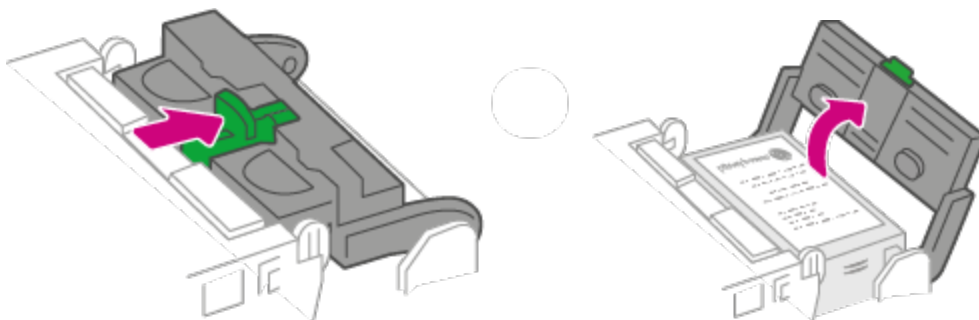

6. Remove the ink cartridge.

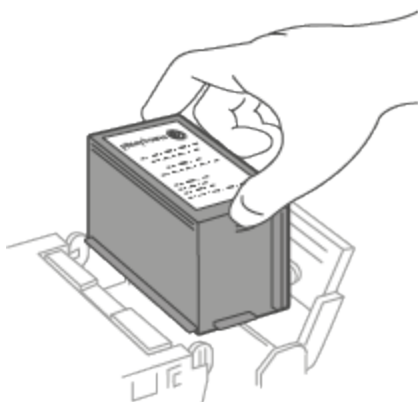

7. Squeeze the two gray tabs on either side of the printhead.

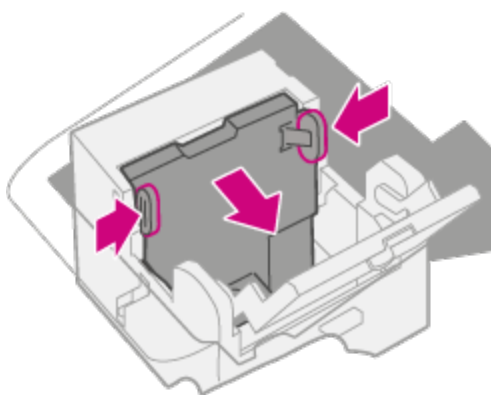

8. While squeezing, lift and tilt the printhead to the right. The printhead should come up out of the device.

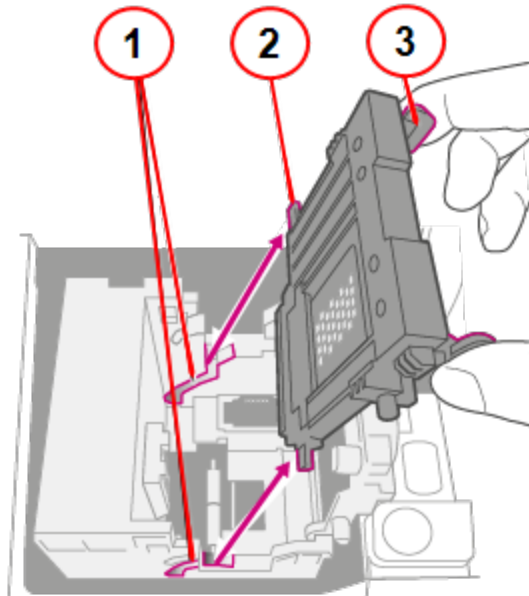

1. Grooves.
2. Peg.
3. Tab.

9. Unwrap the new printhead and remove the protective strip.

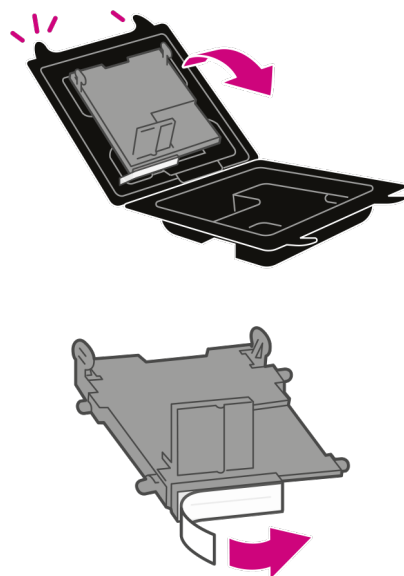

10. Squeeze the tabs and slide the printhead pegs into the lower set of grooves.

Warning: If you do not seat the printhead correctly it can damage the device.

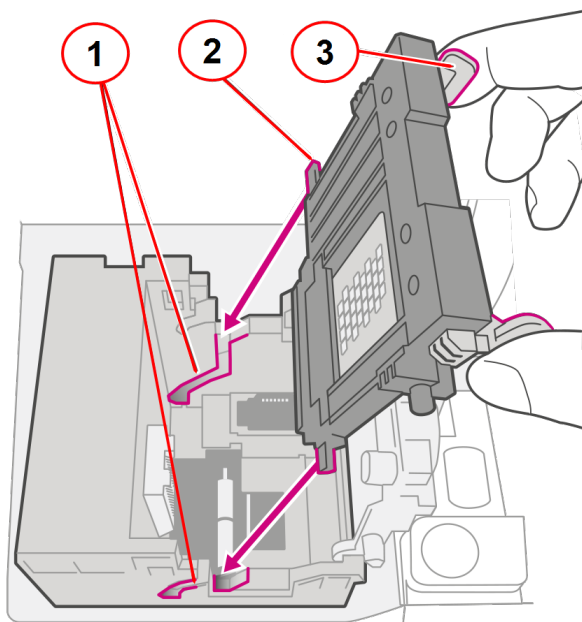

1. Grooves.
2. Peg.
3. Tab.

11. Keep squeezing the tabs and push the printhead flush against the wall. Tabs will snap outward when placed correctly.

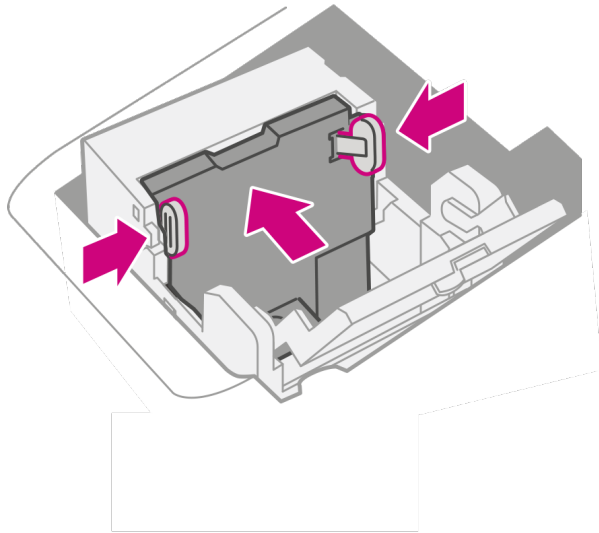

12. Install the ink cartridge and close the guard.

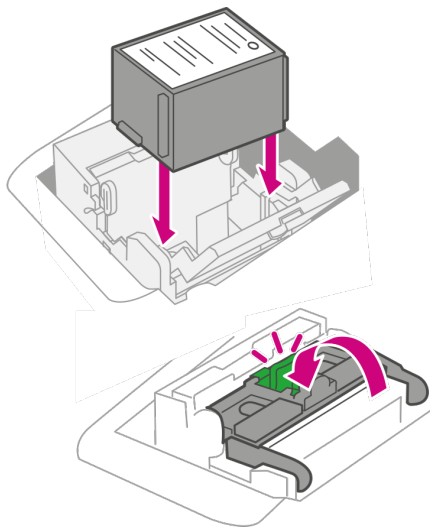

13. Close the cover. The ink cartridge moves back to the original position.

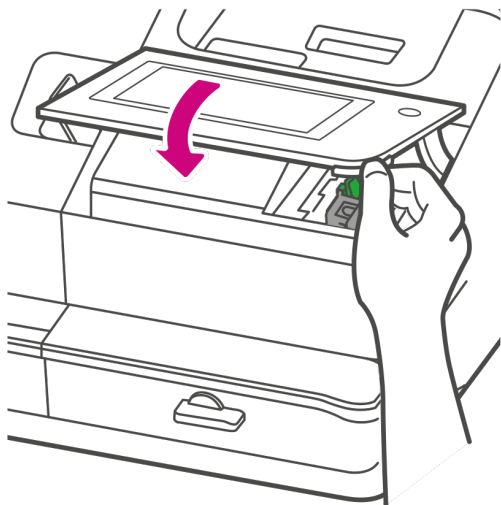

14. Tap **Done**.
15. Print a print test pattern to be sure that your printhead is working properly.

Cleaning the moistener brush and wick assembly

Clean the moistener brush and wick if the moistener tank is full and your envelopes are not sealing properly.

1. Unscrew the plastic thumbscrew under the moistener base.

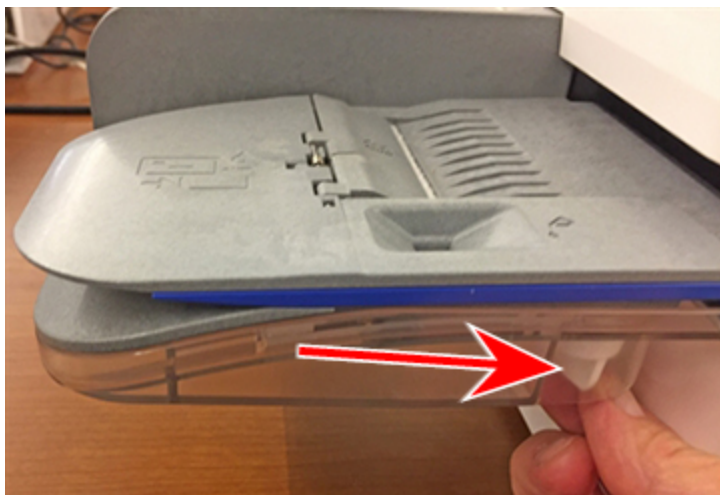

2. Lift the moistener brush assembly off the top of the moistener base.



3. Turn the assembly over and slide the moistener brush out of the holder.

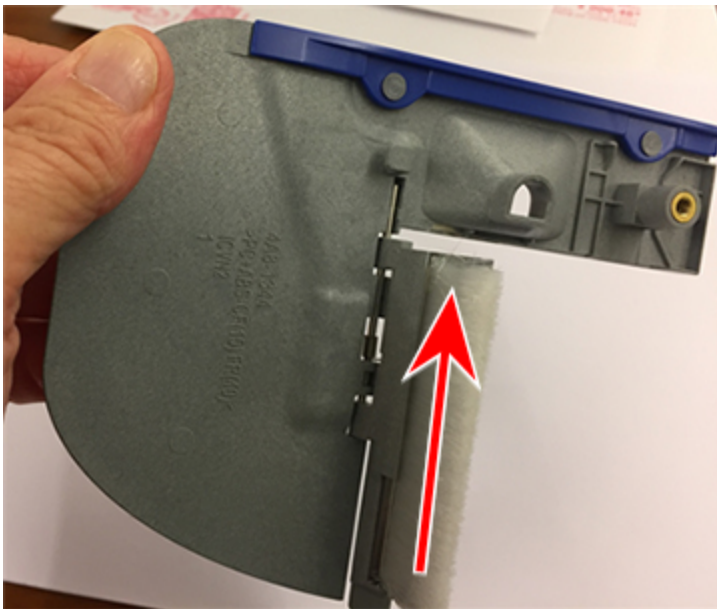

4. Locate the wick on the moistener base.

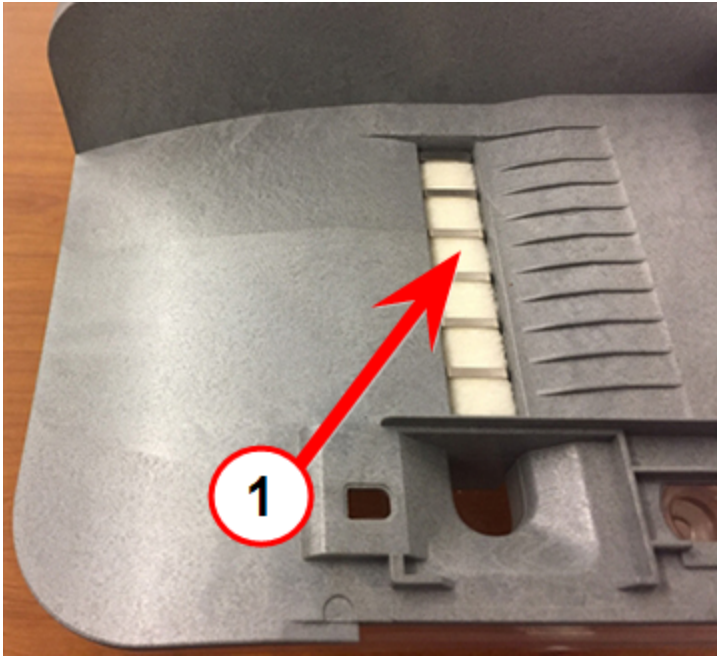

1. Wick.

5. Remove the metal grate and wick from the moistener base.

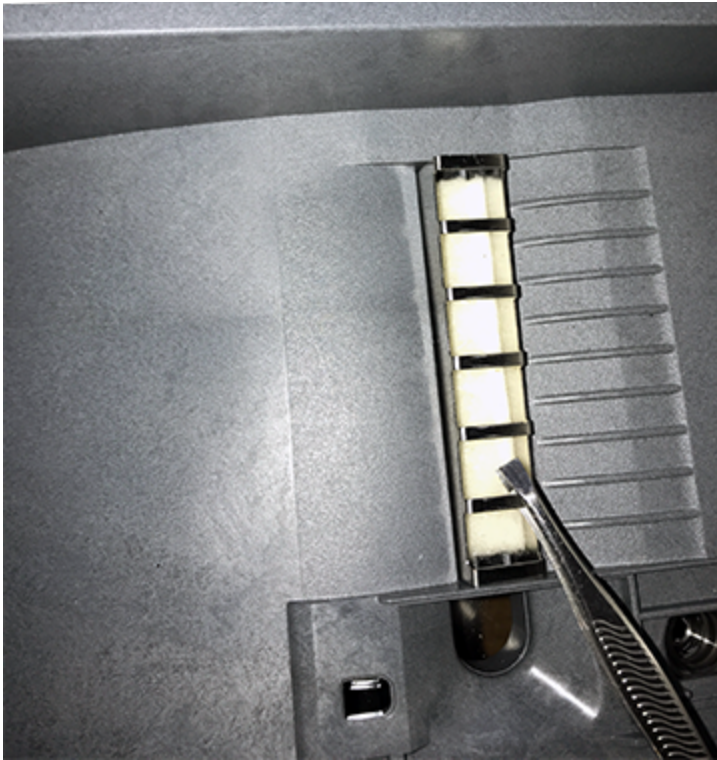

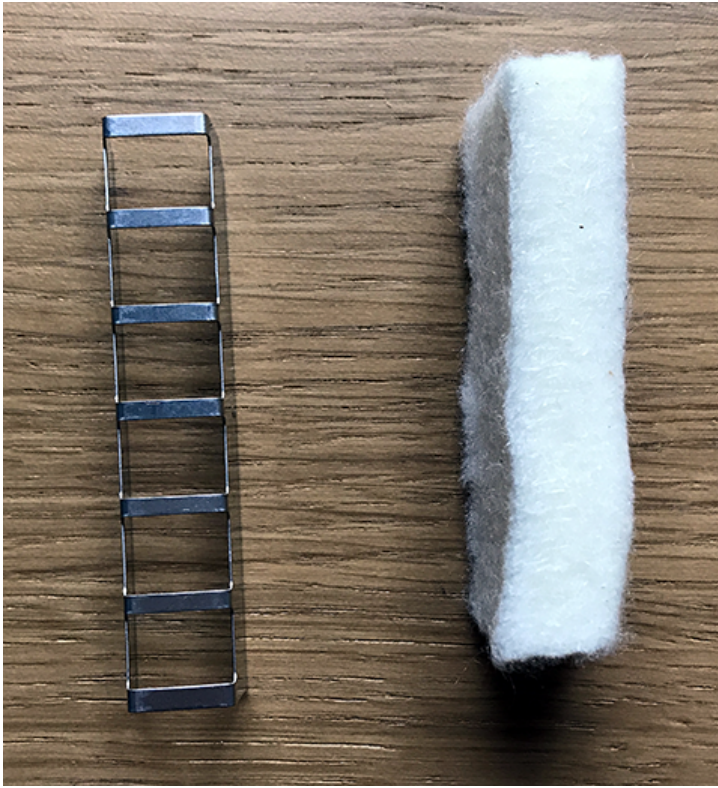

6. Clean the brush and wick with water and rinse thoroughly.
7. Place the wick back in the metal grate and replace the grate in the moistener base.
8. Slide the moistener brush back into the holder.
9. Replace the moistener brush assembly on top of the moistener base and secure with the plastic thumbscrew.
10. If your envelopes still are not sealing properly, you can order a Moistener Replacement Kit by visiting our [supplies website](#).

Filling the moistener tank

Your device will need refills of E-Z Seal® in order to seal envelopes. Follow these steps to fill the moistener tank.

1. Check the level of E-Z Seal® in your moistener tank (1).

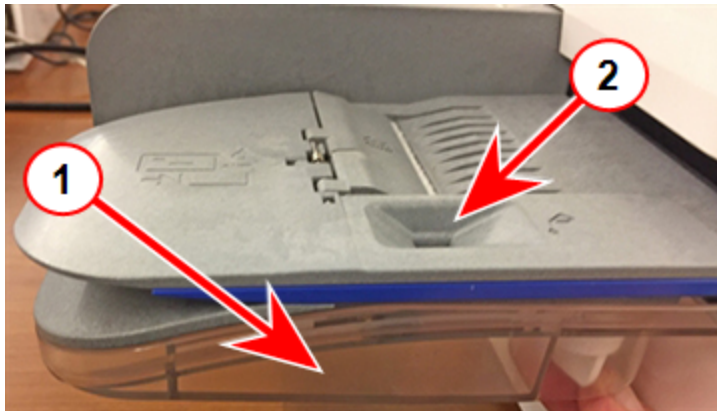

2. Add enough E-Z Seal® to bring the sealant level up to the bottom of the fill hole (2). Do not overfill the tank.
3. If the tank is empty, allow 30 minutes for the moistener brush and wick to get completely wet.

Avoiding envelope sealing issues

Prevent sealing issues by:

- Having enough sealant in the moistener tank.
 - Placing the envelope correctly on the feed deck.
 - Maintaining the wick or brush in the moistener.
1. Check the level of sealant in the moistener tank. Add more if required.

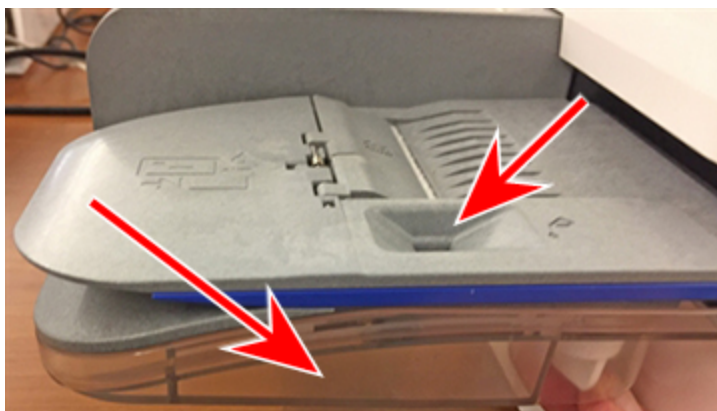

2. Slide the envelope flap under the edge of the feed deck when inserting an envelope. Otherwise, the moistener cannot wet the flap.

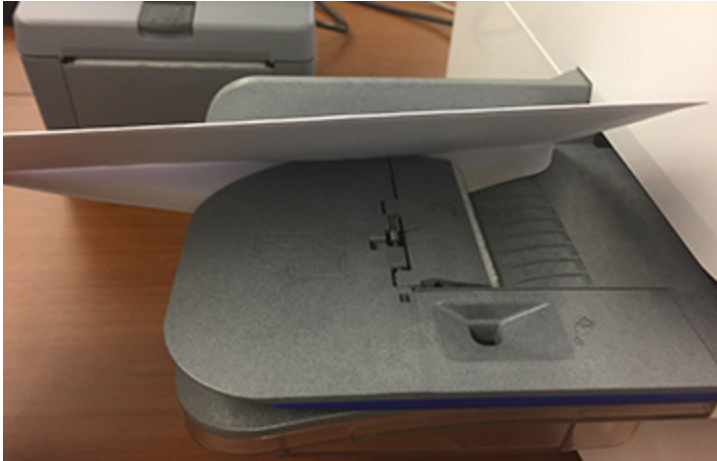

3. If the moistener tank is full, and your envelopes are still not sealing correctly, clean or replace your moistener brush and wick.

Preventing envelope feeding problems

Ensure you feed envelopes correctly to help prevent feeding problems.

Feeding mail

1. For your first envelope, hold the far edge of the envelope against the back wall of the feeder.
2. Slide the envelope into the feeder until you feel it touch the rollers. You hear the motor begin. Do not release the envelope until the feeder grabs it to pull it through the device.

3. You hear the motor continue to run for about 5 seconds once it prints postage on the envelope.
4. Continue to feed envelopes one at a time. Make sure you press the edge of each envelope against the back wall of the feeder and into the feeder until it touches the rollers.
 - Make sure the envelopes fully exit the feeder and do not pile up on the edge of the feeder.
 - If you are using a stacker, you may need to extend the stacker tray so that the envelopes exit the feeder completely.

Hold the envelope against the back wall to avoid skews

If you do not hold the envelope against the back wall, it can feed in crooked or skewed. A skewed envelope can either exit the device with no postage applied or cause a jam. The message Clear Paper Jam appears. This could deduct funds. Even a minor skew that may be difficult to see can cause a jam.

Preventive action

To prevent envelope feeding problems:

- Using a can of non-flammable compressed air, blow on the feed deck on the left side and work toward the transport deck on the right side. Make sure to remove all the dust and debris.

Moving the SendPro C Lite, SendPro C, SendPro+

Move your device safely, whether you are moving it across the room or to a new facility.

1. If you have a scale, remove it from the device.
2. Remove the moistener assembly. Once you have removed and cleaned the assembly, place it in a zip-top bag to prevent any remaining fluid from leaking.
3. Remove the ink cartridge. Once you get the ink cartridge out, place it in a zip-top bag.
4. Close the top cover.
5. Remove all USB cables and optional peripherals such as printers or scanners. Pack them with the device.
6. Unplug the power cord and pack it with the device.
7. Once in the new location, re-install all USB cables and peripherals.
8. Plug the power cord into the device and power outlet.

9. Re-install the ink cartridge.
10. Re-install the moistener assembly.

If you're moving to a new ZIP Code the device will need to be updated.

8 - Supplies

In this section

Ordering supplies.....	138
------------------------	-----

Ordering supplies

Visit our [supplies website](#) to order supplies for your device.

9 - Device Information

In this section

USPS requirements.....	140
Key in Postage.....	140
Sections of the meter impression.....	140
Finding the SendPro application software version.....	141
Postal Security Device.....	142
Parts of the SendPro C Lite, SendPro C, SendPro+....	142
Connections on the back.....	143
Specifications.....	144
Material specifications.....	147

USPS requirements

Since your postage device (Postal Security Device) is licensed by the USPS, you must follow a few basic requirements.

- Mail must have the correct date and postage amount in the postage .
- Metered mail must bear the ZIP Code™ location of the post office where the device is registered.
- If you move to another ZIP Code™ location, you must update the ZIP Code. Visit [Pitney Bowes support](#).
- The USPS requires a postal inspection of your device every 120 days. Each time you refill your device through the network, the PB Postage device Payment System computer automatically performs a postal inspection.
- The postage tape you use must meet USPS specifications.

Key in Postage

The USPS requires your postage to be calculated using a scale. This ensures that your mail always has the correct postage, and that you are not overpaying, or having mail returned for insufficient postage. Key in Postage is not available on any of the SendPro C devices.

Sections of the meter impression

The meter impression contains elements that identify the mailer and the type of mail.

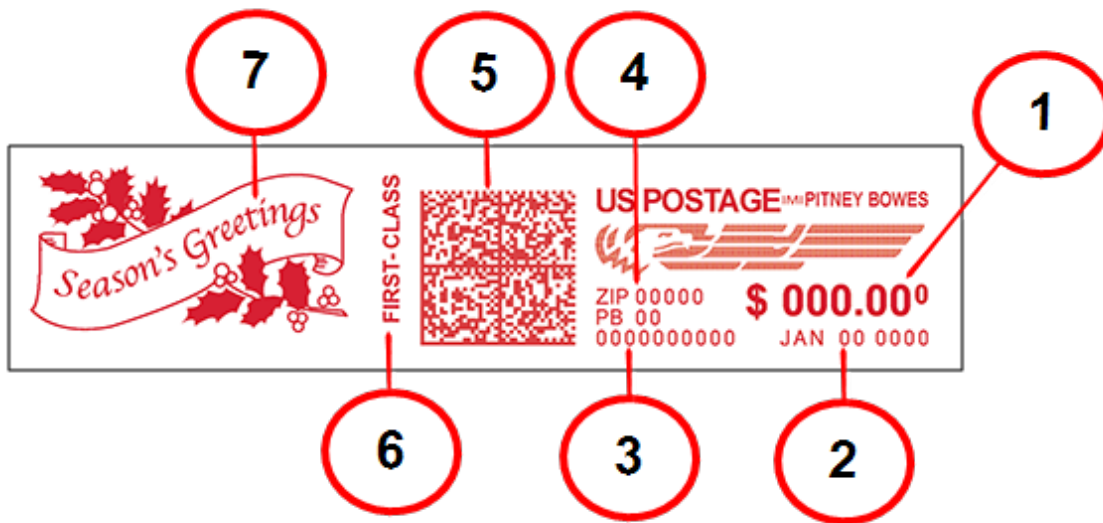

1. Postage amount
2. Date
3. Meter serial number
4. ZIP Code™ of the machine
5. Datamatrix barcode - contains tracking information
6. Optional postal inscription and class.
7. Optional graphic or Postal Endorsement (Postal Endorsements are official USPS instructions that print on the mailpiece).

Finding the SendPro application software version

SendPro is the software that runs many features on your device. If you need to check which version you have, follow these steps.

1. Tap **Settings**.



2. Scroll to Advanced Device Options.
3. Tap **About this Device**.

4. Scroll down to the Applications section and locate the **SendPro™** setting.

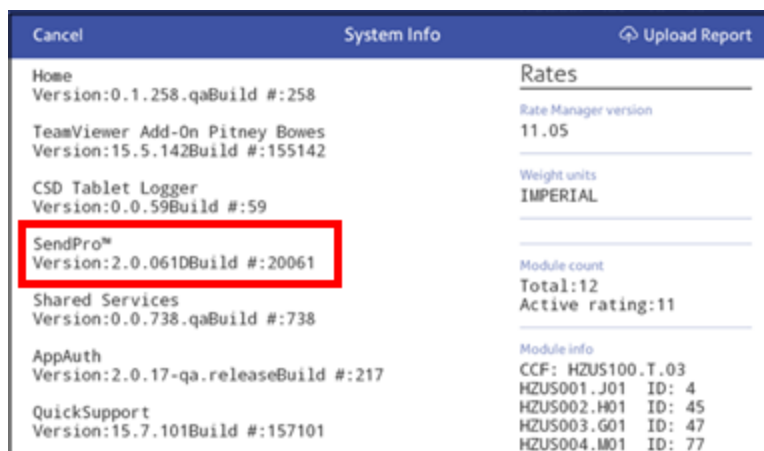

This is the most current software version.

5. Tap **Cancel** to exit the screen.

Postal Security Device

The postage meter on your mailing system is a Postal Security Device (PSD) that secures your postage funds. It includes the latest technology approved by USPS. This technology eliminates the need for USPS to perform physical inspections, thereby making your device easier and more convenient for you to use.

Parts of the SendPro C Lite, SendPro C, SendPro+

Familiarize yourself with the parts of your SendPro C Lite, SendPro C, SendPro+.



1. **Integrated scale** - Weigh envelopes and packages.
2. **Color touchscreen display** - Provides access to the apps available on your device.
3. **Ink access cover** - Allows access to the ink cartridge. Find the model and serial numbers inside.
4. **Envelope stacker** - Mail collects here after the printing process.
5. **Paper jam lever** - If a stall occurs on the transport deck, turn this to clear the envelope, post card or tape strip.
6. **Envelope moistener** - Moistens the flap of the envelope.
7. **Semi-automatic feeder** - Feeds and seals envelopes. Also feeds postcards and tape strips.
8. **Optional thermal label printer** - Not included in System Weights & Measures builds.

Connections on the back

Familiarize yourself with the ports on the back of your device.

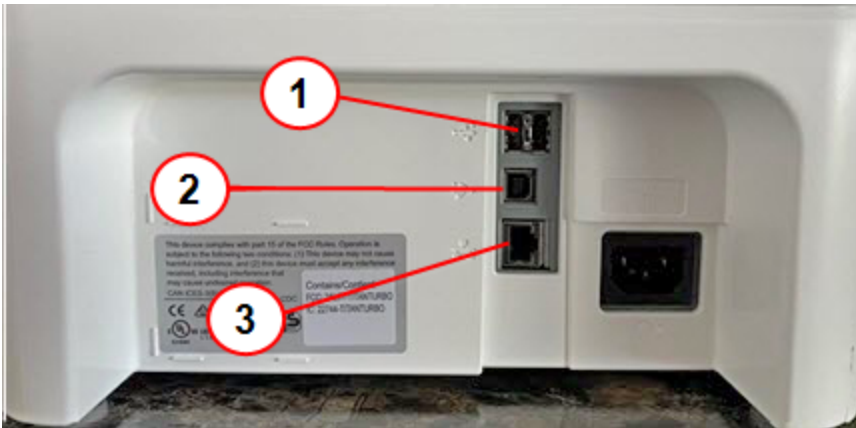

1. **USB port type A host** - Connect a Barcode scanner, external printer or external scale to these ports.
2. **USB port, type B host** - Service personnel use only.
3. **RJ45** - Use for a wired network connection.

Specifications

Review the specifications of your SendPro C Lite, SendPro C, SendPro+ including the throughput, ink cartridge yield and other component details.

Power requirements

100-240 VAC, 50/60 Hz, 1.0 A

Operating Temperature

55°F to 95°F

Sound Level

Less than or equal to 70 dBA re 20 micro Pascal in accordance with ISO 7779, ISO 3744, or ISO 3741.

Dimensions



1. Length 16.5 in
2. Width 15.5 in
3. Height 11.25 in

Weight

17.6 lbs

Throughput (Letters Per Minute)

- SendPro® C Lite - 50 letters per minute
- SendPro® C, SendPro®+ - up to 65 letters per minute

Actual throughput varies, depending on the material used, device condition, use of moistener, etc.

Ink Cartridge Life

- 17 ml cartridge - yields up to 1,500 impressions. (Actual ink yields vary with usage and environmental conditions).
- 35 ml cartridge - yields up to 3,000 impressions. (Actual ink yields vary with usage and environmental conditions).

Ports

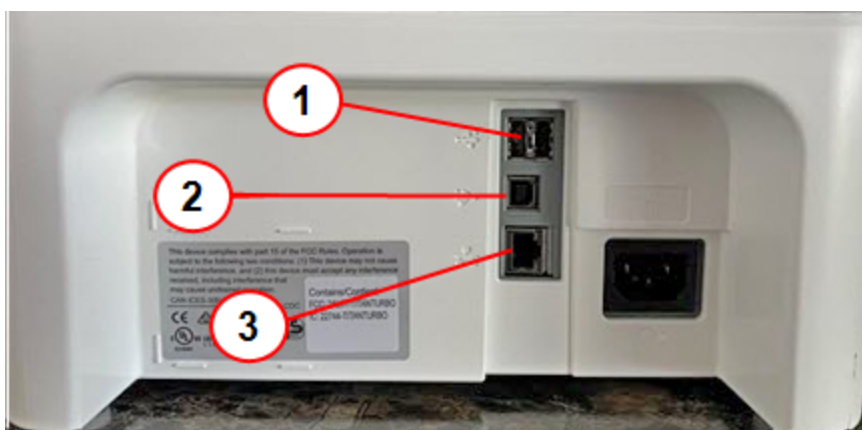

1. **USB port type A host** - Connect a Barcode scanner, external printer or external scale to these ports.
2. **USB port, type B host** - Service personnel use only.
3. **RJ45** - Use for a wired network connection.

Display

7-inch tablet (169 pixels/inch)

Print Resolution

300 H x 600 V dpi

Print Image Area

1 in x 7 in

Tapes and Strips

Self-adhesive, dual tape strip for use on mailpieces that are too large to run in the device. Ideal for adding postage to oversized envelopes, priority mail and packages.

Postal Inscriptions

Up to 60 inscriptions preloaded on the device.

Graphics

Up to 60 graphic ads on the device.

Connectivity Options

- Wired Ethernet connection.
- Wireless connectivity.
- SendPro Cellular connectivity device.

Material specifications

Review the material specifications including the minimum and maximum envelope sizes, envelope stack height, and tape size details.

Envelope dimensions

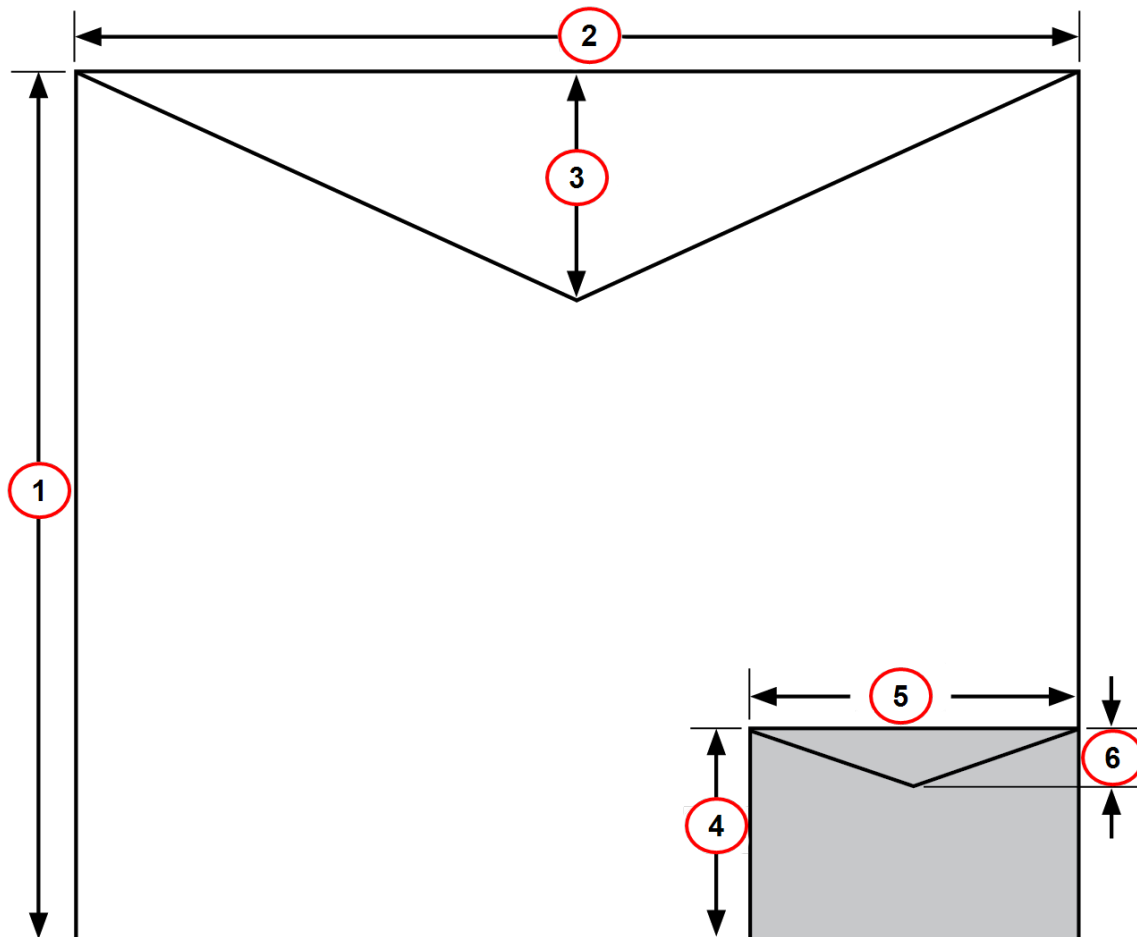

1. Maximum height: 13 in.
2. Maximum width: 15 in.
3. Envelope flap depth, maximum: 3 in
4. Minimum height: 3.5 in
5. Minimum width: 4.75 in
6. Envelope flap depth, minimum: 7/8 in

Envelope Thickness

- Minimum: 0.02 in
- Maximum: 3/8 in

Stack Height for Mail

- 3 in – This is the height of the inner edge of the side guide

Envelope Weight

- Minimum: 0.035 oz
- Maximum: 16 oz

Tape Size

- Minimum: 1.75 x 4 in
- Maximum: 1.76 x 8 in

For a proper seal, the envelope's minimum flap angle must meet the following criteria:

- For envelopes with a flap length from 1-2.36 in, the minimum flap angle is 18 degrees.
- For envelopes with a flap length greater than 2.36 in to the maximum flap length for the particular model, the minimum flap angle is 21 degrees.

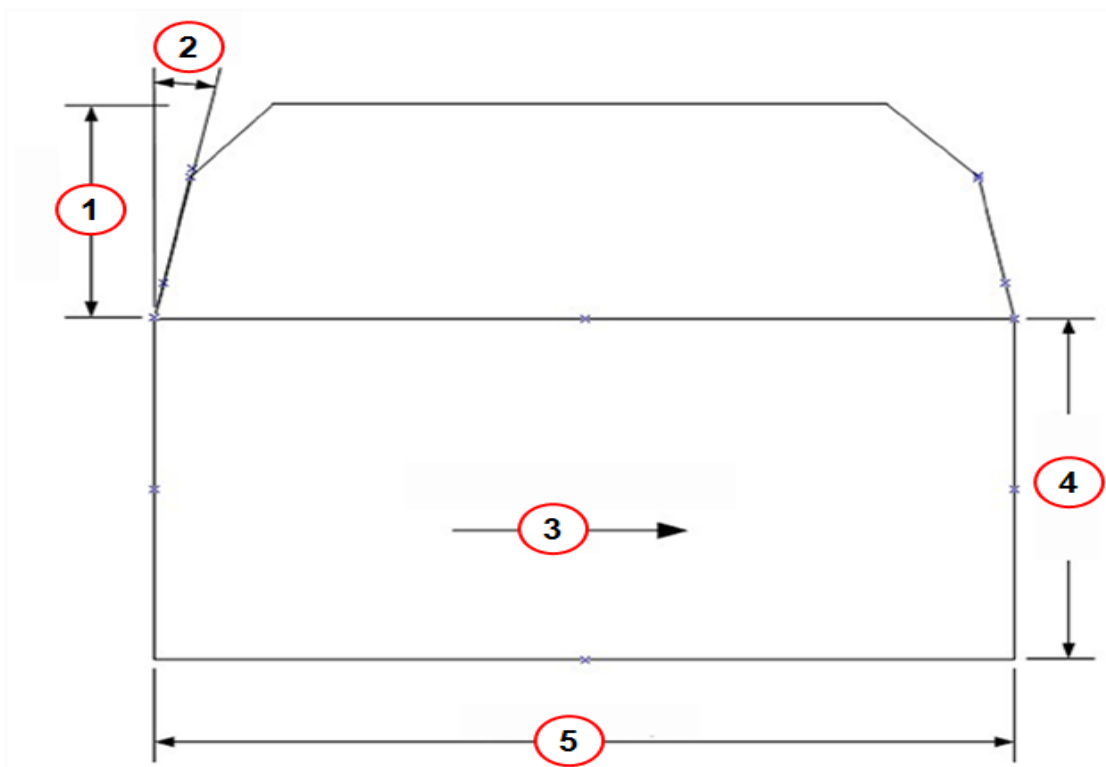

1. Flap length.
2. Minimum flap angle.
3. Mail processing direction.
4. Mailpiece length.
5. Mailpiece width.

10 - Contacting Pitney Bowes

In this section

Contacting Pitney Bowes.....	152
------------------------------	-----

Contacting Pitney Bowes

Before contacting Pitney Bowes Technical Support:

Locate your Product Code Number (PCN) and serial number

In order to find the correct information for your device, you need to know the model number.

To locate the **(1) Product Code Number (PCN)** and the **(2) 7-digit serial number**, check the label on the rear of the device or under the display cover as shown here. Note that the serial number appears blurred here for security reasons.

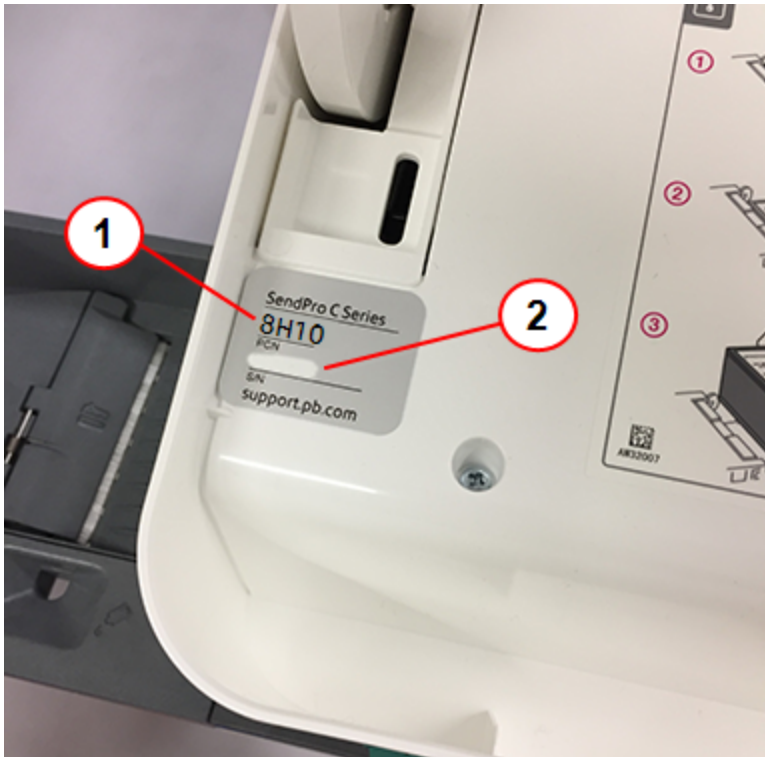

Be sure to have the following information available before contacting Pitney Bowes Technical Support:

Provide a description of the problem

- What is happening and when
- Are there any error messages?

Describe your attempts to fix the problem

- What steps have you already tried to fix the problem?
- If you tried, what happened?

Contact Technical and Account Support

Check the Pitney Bowes support site to make sure you have the latest information about your product. Visit us at: www.pitneybowes.com/support

For Pitney Bowes Supplies

- *SendPro C Lite, SendPro C, SendPro+*
- *SendPro C Auto*

Important: Customer service representatives are available Monday through Friday, 8:00 AM - 8:00 PM EST.

11 - Safety

In this section

Lithium Ion Battery.....	155
Agency Compliance Information.....	155
Important Safety Notes.....	155
Note for California Customers Only on all Models.....	157

SendPro C, SendPro+ (Model 2H00 and 8H00)

Power requirements: 100-240 VAC, 50/60 Hz, 1.0 A

SendPro C (All models)

- Operating Temperature: 55°F (13°C) to 95°F (35°C)
- Sound Level: Less than or equal to 70 dBA re 20 micro Pascal in accordance with ISO 7779, ISO 3744, or ISO 3741.

Lithium Ion Battery

This product contains a lithium ion battery. The battery must be recycled or disposed of properly. If you are leasing this product, you must return it to Pitney Bowes. Alternatively, contact your local waste disposal or recycle facility for instructions on how to dispose of it properly.

Agency Compliance Information

Agency Compliance Information can be found in the product's user guide. The user guide is available for download at: <http://www.pitneybowes.com/us/support>.

Important Safety Notes

Follow the normal safety precautions for all office equipment.

- Please read all instructions before you attempt to operate the system. Save these instructions for future use.
- Use only Pitney Bowes-approved supplies, in particular aerosol dusters. Improper storage and use of aerosol dusters or flammable aerosol dusters can cause an explosive-like condition that could result in personal injury and/or property damage. Never use aerosol dusters labeled flammable and always read instructions and safety precautions on the duster label.
- Use the power cord supplied with the machine and plug it into a properly grounded wall outlet that's located near the machine and easily accessible. Failure to properly ground the machine can result in severe personal injury and/or fire.
- The power cord wall plug is the primary means of disconnecting the machine from the AC supply. The unit is on whenever it is plugged into a live receptacle, even though the operator display may be blank.

- Place the mailing machine base close to an easily accessible wall outlet. DO NOT use a wall outlet controlled by a wall switch or one that is shared with other equipment.
- Do not use an adapter plug on the line cord or wall outlet.
- Do not remove the ground pin from the line cord.
- Make sure the area in front of the wall outlet into which the machine is plugged is free from obstruction.
- DO NOT route the power cord over sharp edges or trap it between pieces of furniture. Make sure there is no strain on the power cord.
- To reduce the risk of fire or electrical shock, DO NOT attempt to remove covers or disassemble the control panel or its base. The cabinet encloses hazardous parts. If you should drop or otherwise damage the unit, call Pitney Bowes.
- Use only Pitney Bowes approved ink, tape strips, and cleaners. To obtain Material Safety Data Sheets (MSDS) for OSHA requirements, please go to www.pb.com/msds. When prompted, enter the product name, manufacturer, the Pitney Bowes MSDS Number, or reorder number of the item you are interested in.
- Keep fingers, long hair, jewelry and loose clothing away from moving parts at all times.
- Avoid touching moving parts or materials while the machine is in use. Before clearing a stall (jam), be sure machine mechanisms come to a complete stop.
- To prevent overheating, do not cover the vent openings.
- When removing stalled material, avoid using too much force to protect against minor personal injury and damage to the equipment.
- Use the equipment only for its intended purpose.
- Always follow the specific occupational safety and health standards prescribed for your workplace.



Caution:

In case of an ink spill, leaking ink or excessive ink accumulation, immediately disconnect the power cord from the wall plug and contact Pitney Bowes. All inquiries can be done by visiting www.pitneybowes.com/us/support. Customer Service Representatives are available Monday through Friday, 8:00 AM - 8:00 PM ET.

Note for California Customers Only on all Models

Batteries in this product contain perchlorate material. California requires perchlorate-containing products to be accompanied by the following notice: Perchlorate Material - special handling may apply. See: <http://www.dtsc.ca.gov/hazardouswaste/perchlorate/>

Servicing

Please refer to the warranty information if problems occur. For reference purposes, the Pitney Bowes U.S. Service Center contact address is: Pitney Bowes Inc., 3001 Summer Street, Stamford, CT, 06926. All inquiries can be done by visiting www.pitneybowes.com/us/support. Customer Service Representatives are available Monday through Friday, 8:00 AM - 8:00 PM ET.

12 - Third party software

In this section

Third party software.....	159
---------------------------	-----

Third party software

Third party software may have been incorporated into this product by Pitney Bowes Inc. (“PBI”) under permission from PBI’s licensors. Any special terms and conditions that apply to such software are provided below:

This product contains the following software:

- Okhttp3 which is licensed under the Apache License, Version number 2.0. The license can be downloaded from: <http://www.apache.org/licenses/LICENSE-2.0.html>. The source code for this software is available from <http://square.github.io/okhttp/>.
- Retrofit which is licensed under the Apache License, Version number 2.0. The license can be downloaded from: <http://www.apache.org/licenses/LICENSE-2.0.html>. The source code for this software is available from <https://square.github.io/retrofit/>.
- Okio which is licensed under the Apache License, Version number 2.0. The license can be downloaded from: <https://github.com/square/okio/blob/master/LICENSE.txt>. The source code for this software is available from <https://github.com/square/okio>.
- Commons-codec which is licensed under the Apache License, Version number 2.0. The license can be downloaded from: <http://www.apache.org/licenses/LICENSE-2.0.html>. The source code for this software is available from https://commons.apache.org/proper/commons-codec/download_codec.cgi.
- Commons-io which is licensed under the Apache License, Version number 2.0. The license can be downloaded from: <http://www.apache.org/licenses/LICENSE-2.0.html>. The source code for this software is available from https://commons.apache.org/proper/commons-io/download_io.cgi.
- Org.greenrobot:eventbus which is licensed under the Apache License, Version number 2.0. The license can be downloaded from: <http://www.apache.org/licenses/LICENSE-2.0.html>. The source code for this software is available from <http://greenrobot.org>.
- Org.greenrobot:greendao which is licensed under the Apache License, Version number 2.0. The license can be downloaded from: <http://www.apache.org/licenses/LICENSE-2.0.html>. The source code for this software is available from <http://greenrobot.org/greendao>.
- FasterXml.jackson.core:jackson-core which is licensed under the Apache License, Version number 2.0. The license can be downloaded from: <http://wiki.fasterxml.com/JacksonLicensing>. The source code for this software is available from <http://wiki.fasterxml.com>.
- Aws-android-sdk-core which is licensed under the Apache License, Version number 2.0. The license can be downloaded from: <https://github.com/aws/aws-sdk-android/blob/master/LICENSE.APACHE.txt>. The source code for this software is available from <https://github.com/aws/aws-sdk-android>.

- Aws-android-sdk-iot which is licensed under the Apache License, Version number 2.0. The license can be downloaded from: <https://github.com/aws/aws-sdk-android/blob/master/LICENSE.APACHE.txt>. The source code for this software is available from <https://github.com/aws/aws-sdk-android>.
- Aws-android-sdk-s3 which is licensed under the Apache License, Version number 2.0. The license can be downloaded from: <https://github.com/aws/aws-sdk-android/blob/master/LICENSE.APACHE.txt>. The source code for this software is available from <https://github.com/aws/aws-sdk-android>.
- Nv-websocket-client which is licensed under the Apache License, Version number 2.0. The license can be downloaded from: <http://www.apache.org/licenses/LICENSE-2.0.html>. The source code for this software is available from <https://github.com/TakahikoKawasaki/nv-websocket-client>.
- bumptech.glide which is licensed under the Apache License, Version number 2.0. The license can be downloaded from: <http://www.apache.org/licenses/LICENSE-2.0.html>. The source code for this software is available from <https://github.com/bumptech/glide>.
- Jakewharton:butterknife which is licensed under the Apache License, Version number 2.0. The license can be downloaded from: <http://www.apache.org/licenses/LICENSE-2.0.html>. The source code for this software is available from <https://github.com/JakeWharton/butterknife>.
- Caverock:androidsvg which is licensed under the Apache License, Version number 2.0. The license can be downloaded from: <http://www.apache.org/licenses/LICENSE-2.0.html>. The source code for this software is available from <https://mvnrepository.com/artifact/com.caverock/androidsvg/1.2.1>.
- Glassfish:javax.annotation which is dual licensed under the CDDL, Version 1.0, and the GNU General Public License, Version 2, June 1991, with the Classpath Exception. The licenses can be downloaded from: <https://javaee.github.io/glassfish/LICENSE>. The source code for this software is available from <https://javaee.github.io/glassfish>.
- CalligraphyXamarin which is licensed under the Apache License, Version number 2.0. The license can be downloaded from: <http://www.apache.org/licenses/LICENSE-2.0.html>. The source code for this software is available from <https://github.com/mikescandy/Calligraphy-xamarin>.
- Newtonsoft JSON.NET which is licensed under the MIT License. The license can be downloaded from: <https://github.com/JamesNK/Newtonsoft.Json>. The source code for this software is available from <https://github.com/JamesNK/Newtonsoft.Json>.
- MaterialChips which is licensed under the Apache License, Version number 2.0. The license can be downloaded from: <http://www.apache.org/licenses/LICENSE-2.0.html>. The source code for this software is available from <https://github.com/DoodleScheduling/android-material-chips>.

- Android Open Source Project (“AOSP”), which is licensed under the Apache License, Version number 2.0. The license can be downloaded from: <http://www.apache.org/licenses/LICENSE-2.0.html>. AOSP also contains the Linux kernel which is licensed under GNU General Public License, Version 2, June 1991 (“GPL”). The license can be downloaded from: <http://www.gnu.org/licenses/gpl-2.0.html> Copyright © 1989, 1991 Free Software Foundation. For up to three years from PBI’s distribution of this product, you may obtain a complete machine-readable copy of the source code for the Linux kernel under the terms of the GPL, without charge except for the cost of the media, shipping, and handling, upon written request to PBI. Such requests should be sent by e-mail to iptl@pb.com.
- This product contains Paho.mqtt.java, which is licensed under the Eclipse Public License - v 2.0 and the Eclipse Distribution License - v 1.0. The licenses can be downloaded from <https://www.eclipse.org/legal/epl-2.0/> and <https://www.eclipse.org/org/documents/edl-v10.php>, respectively. The modified source code can be downloaded from: <https://github.com/PitneyBowes>.



3001 Summer Street
Stamford, Connecticut 06926
www.pitneybowes.com

For Service or Supplies

SV63421 Rev. A
©2024 Pitney Bowes Inc.
All Rights Reserved