



Shipping & Mailing
Postage Meters

SendPro® C Lite, SendPro® C, SendPro®+

Operator Guide

Canadian English Edition
SV63317-enca Rev.A
July 29, 2024

©2024 Pitney Bowes Inc.

All rights reserved. This book may not be reproduced in whole or in part in any fashion or stored in a retrieval system of any type or transmitted by any means, electronically or mechanically, without the express written permission of Pitney Bowes.

The use of this information by the recipient or others for purposes other than the training of customers on Pitney Bowes equipment may constitute an infringement of intellectual property rights of Pitney Bowes, and Pitney Bowes assumes no responsibility for any such use of the information.

We have made every reasonable effort to ensure the accuracy and usefulness of this manual. However, we cannot assume responsibility for errors or omissions or liability for the misuse or misapplication of our products.

Except as provided in writing, duly signed by an officer of Pitney Bowes, no license either express or implied, under any Pitney Bowes or third party's patent, copyright or other intellectual property rights is granted by providing this information.

PB Postage™ is a trademark of Pitney Bowes Inc.

Table of Contents

1 - Quick start guide

Finding the Product Code Number (PCN) and serial number	9
Navigating the Home screen on the SendPro C Lite, SendPro C, SendPro+	10
Printing a shipping label	12
Printing postage on envelopes	18
Sending a Lettermail™ envelope	19
Using Canada Post special services	19
Adding a graphic to your envelope in Print on Envelopes	20
Using the scale when printing postage	20
Sealing envelopes when you print postage	22
Sealing envelopes without printing postage	23
Filling the moistener tank	24
Replacing the ink cartridge	25
Printing a test pattern	27
Supplies, ink cartridges, and options	29

2 - Connectivity

Setting up a wired network connection	31
Setting up a wireless (Wi-Fi) network connection	34
Connecting to a hidden Wi-Fi network	34
Forgetting a Wi-Fi network	36
Checking your network connection	38
Finding the MAC address for wired and wireless networks	39
Setting up a Proxy server	42

3 - Scales and Weighing

Installing a scale	47
--------------------------	----

Using the scale when printing postage	47
Entering the weight manually when printing postage	48
Zeroing the scale	49

4 - Accounting

What is Accounting	52
Adding a Print on Envelopes account	53
Turning Print on Envelopes account passwords on or off for printing postage	54
Editing an account	55
Deleting a Print on Envelopes account	56
Emailing an account report	57

5 - Postage Funding

Checking the available funds for printing postage	61
Refilling postage funds for printing postage	63
Viewing receipts for refilling postage for Print on Envelopes	64
Changing the default refill amount for printing postage	64
Viewing the postage refill history	65
Checking your PitneyWorks® balance	65
Getting a Canada Post refund for damaged or incorrectly printed mail in Print on Envelopes	66
Viewing the total spent on printing postage	66
Setting the low funds warning for printing postage	67

6 - Mailing and Shipping

Printing a shipping label	69
Printing an international shipping label	75
Reprinting a Canada Post, UPS or FedEx shipping label	75
Printing a Canada Post return shipping label	76
Getting a Canada Post refund for a shipping label	76
Adding a shipping label cost account	77
Sending a Lettermail™ envelope	78

Using Canada Post special services	79
Key in Postage	79

7 - Address Management

Using the Address Book	81
Creating a shipping label from the Address Book	81
Creating a new sender address for shipping labels	81
Editing the sender address for shipping labels	82

8 - Sealing

Filling the moistener tank	84
Sealing envelopes when you print postage	84
Sealing envelopes without printing postage	86
Avoiding envelope sealing issues	87

9 - History and Reports

Printing a funds report	90
Running account reports	90
Setting the report period for an account	91
Setting the account report preferences	92

10 - Printing

Printing additional postage	95
Adding a graphic to your envelope in Print on Envelopes	95
Printing a graphic without printing postage	96
Printing only the date and time	96
Printing a test pattern	98

11 - Feeding and Jamming

Preventing envelope feeding problems	100
--	-----

12 - Ink

Ordering ink cartridges	103
-------------------------------	-----

13 - Settings

Creating or disabling the security PIN	105
Adjusting time zone and scale location code	106
Advancing the date	106
Re-dating your mail	107
Adjusting display brightness	107
Comparing rates for classes and services for Print on Envelopes	108
Uploading postage transactions	109
Clearing or resetting the number of mailpieces sent	109
Performing Canada Post postal inspections for postage printing	110
Uploading system logs	110

14 - Rate Change

Updating postal rates or software for Print on Envelopes	113
--	-----

15 - Maintenance

Installing the printhead	115
Cleaning the printhead	120
Cleaning the moistener brush and wick assembly	125
Supplies, ink cartridges, and options	130

16 - Product Information

Printing postage on envelopes	132
Moving the SendPro C Lite, SendPro C, SendPro+	133
Canada Post requirements	133
Sections of the meter impression	134
Postal Security Device	134
Parts of the SendPro C Lite, SendPro C, SendPro+	134
Connections on the back	135
Specifications	136
Material specifications	139
Contacting Pitney Bowes	142
Third party software	143

1 - Quick start guide

In this section

Finding the Product Code Number (PCN) and serial number.....	9
Navigating the Home screen on the SendPro C Lite, SendPro C, SendPro+.....	10
Printing a shipping label.....	12
Printing postage on envelopes.....	18
Sending a Lettermail™ envelope.....	19
Using Canada Post special services.....	19
Adding a graphic to your envelope in Print on Envelopes.....	20
Using the scale when printing postage.....	20
Sealing envelopes when you print postage.....	22
Sealing envelopes without printing postage.....	23
Filling the moistener tank.....	24
Replacing the ink cartridge.....	25
Printing a test pattern.....	27
Supplies, ink cartridges, and options.....	29

Finding the Product Code Number (PCN) and serial number

In order to find the correct information for your device, you need to know the model number.

To locate the **(1) Product Code Number (PCN)** and the **(2) 7-digit serial number**, check the label on the rear of the device or under the display cover. The serial number appears as zeros here for security reasons.

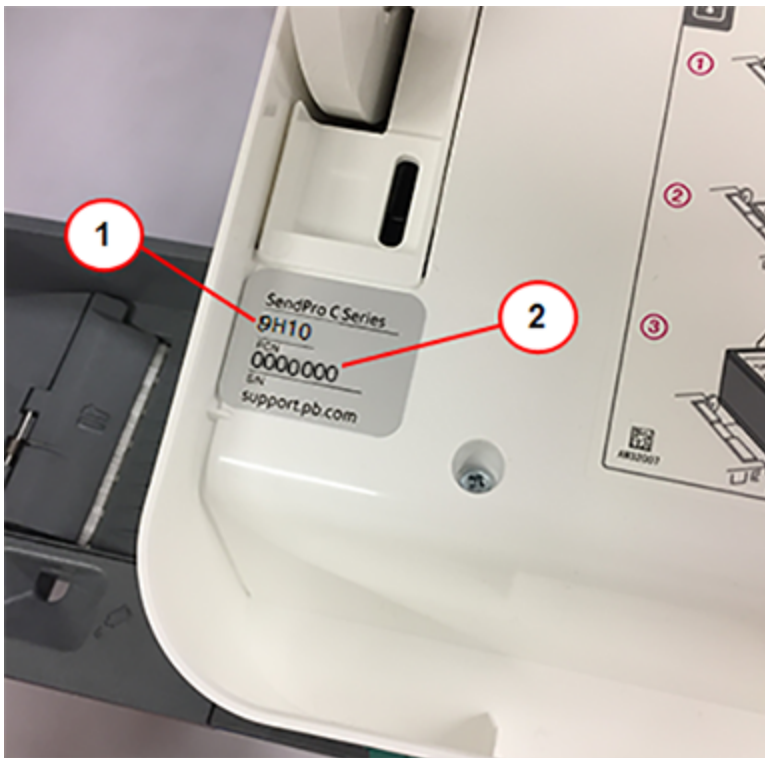

Navigating the Home screen on the SendPro C Lite, SendPro C, SendPro+

The Home screen on the SendPro C Lite, SendPro C, SendPro+ provides the starting point for creating either a shipping label or printing postage.

Tap **Print on Envelopes** to print postage for envelopes and post cards. Tap **Create Shipping Labels** to create a shipping label for important large envelopes or packages.

Tap **SendPro Apps** to view additional apps.

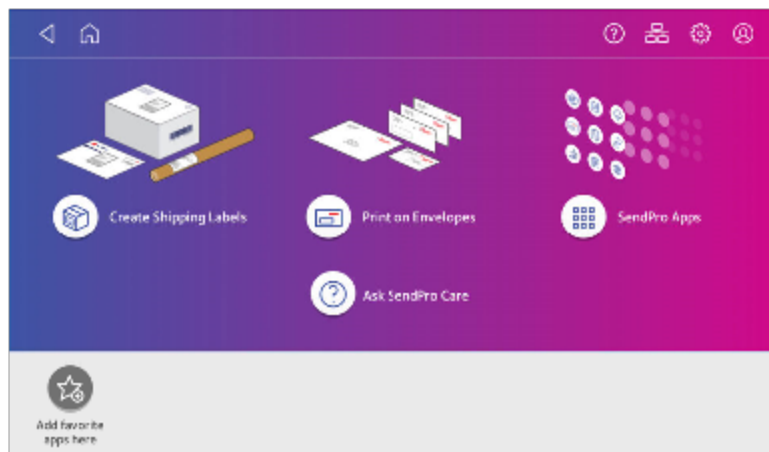

Toolbar

The toolbar located at the top of the Home screen appears at the top of every screen. It allows you to view and change settings for your SendPro C Lite, SendPro C, SendPro+.



1. **Back** - Return to the previous screen.
2. **Home** - Return to the Home screen from anywhere in Create Shipping Labels or Print on Envelopes.
3. **Support** - Search support content and get information on how to use Create Shipping Labels and Print on Envelopes.
4. **Network** - View the current network type (wireless or Ethernet) and status and strength (for wireless connection). The image here represents a wireless connection.
5. **Settings** View or change your device settings. This includes adjusting the screen brightness, setting sound notification levels, and viewing wireless or Ethernet connection information.
6. **Profile** - View your profile (name and email for Create Shipping Labels account), log out, or lock your device.

Printing a shipping label

Use Create Shipping Labels to get the best pricing, free tracking, and detailed delivery history for Canada Post package services. You can also send via UPS® or FedEx®. The packaging options and benefits are almost identical.

1. Tap **Create Shipping Labels** on the Home screen.

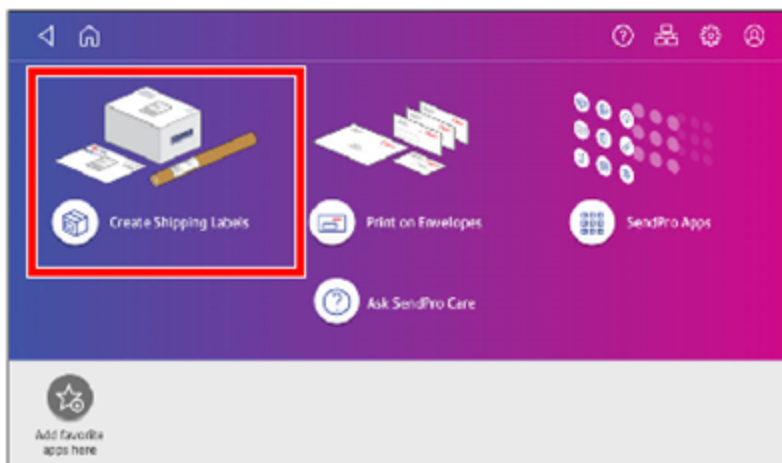

2. Tap the carrier you wish to use.

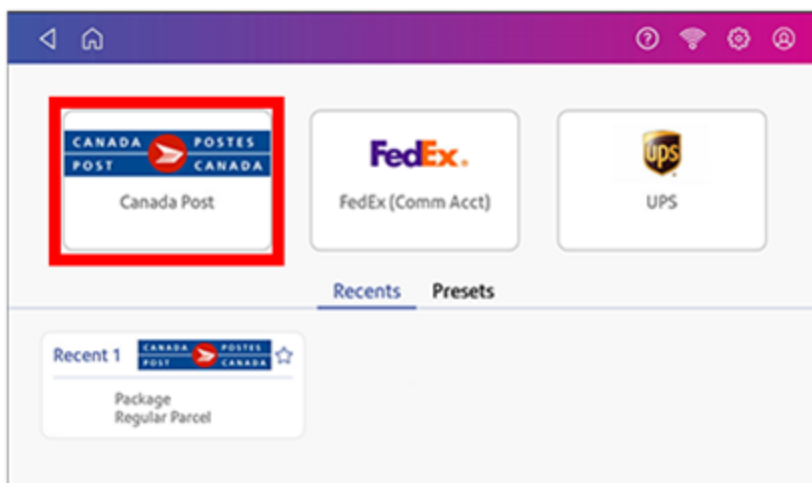

3. Verify that the sender address is correct. If not, tap on the **Sender** field and select a new address.

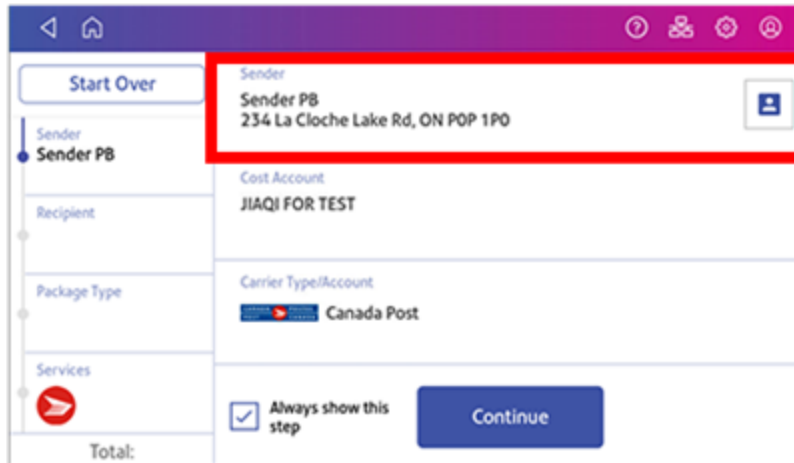

The screenshot shows the 'Sender' field in the SendPro app interface. The field is highlighted with a red border and contains the text: 'Sender PB' and '234 La Cloche Lake Rd, ON POP 1P0'. Below the 'Sender' field, the 'Cost Account' field is visible with the text 'JIAQI FOR TEST'. The 'Carrier Type/Account' field shows the Canada Post logo and text. At the bottom, there is a checkbox labeled 'Always show this step' which is checked, and a blue 'Continue' button.

4. If you have enabled cost accounts on your SendPro C Lite, SendPro C, SendPro+, you must provide an account. If this field contains an account, verify the account is correct. To change or add an account, tap on the **Cost Account** field and select an account from the list.
5. Tap **Continue**.

6. Enter the recipient address.
 - a. You can manually enter the recipient information or select one from the address book. To select one from the address book, tap the address book icon in the upper right corner of the screen.

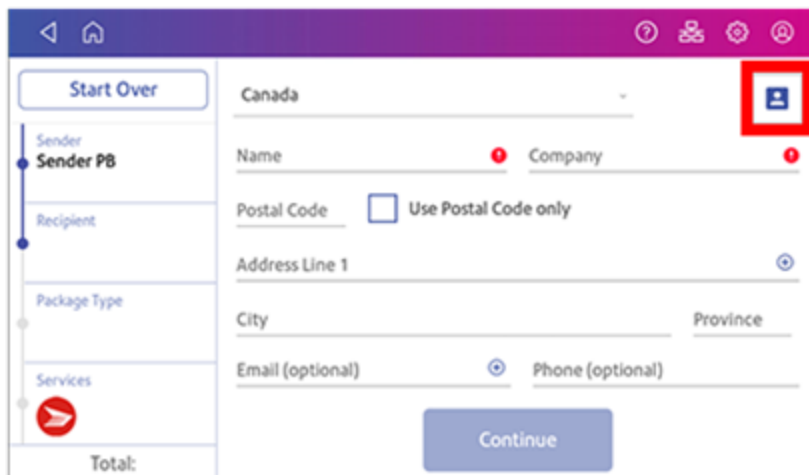

- b. For Canada Post domestic shipments, if your package already has an address, you can select the **Use Postal Code only** box and enter the postal code to create the label without entering the address.

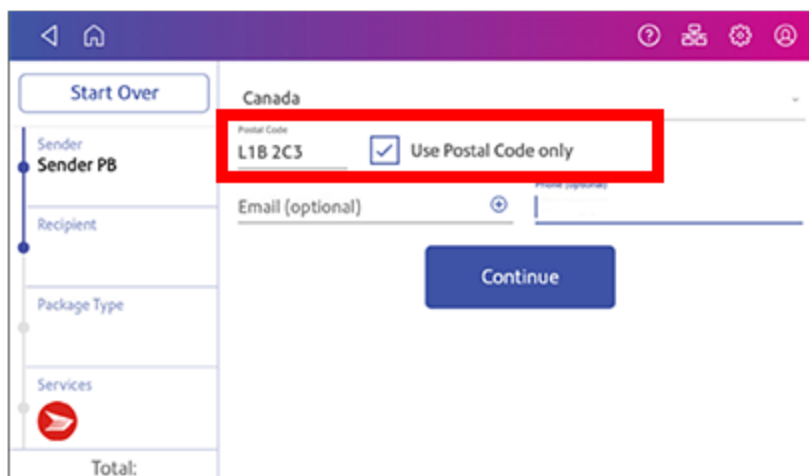

7. Tap **Continue**.

- Tap a package type.

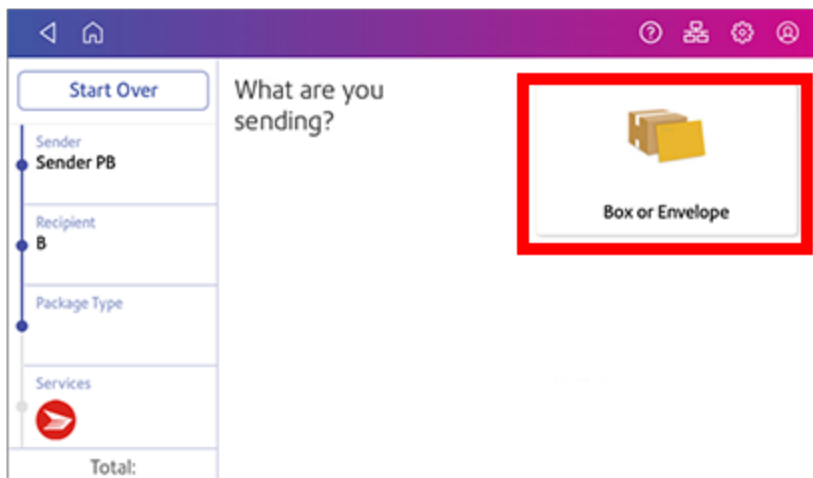

- Enter the dimensions and the weight of the box or envelope:
 - Tap each dimension and enter a value using the display keypad. Tap the green check mark when done.
- Enter the weight:
 - If you have an attached scale, tap **Weight**, then select **Scale**. Place the box or envelope on the scale.
 - If you do not have a scale, tap on the **Weight** field, enter the value using the keypad, then tap **Apply**.
- Tap **Continue**.

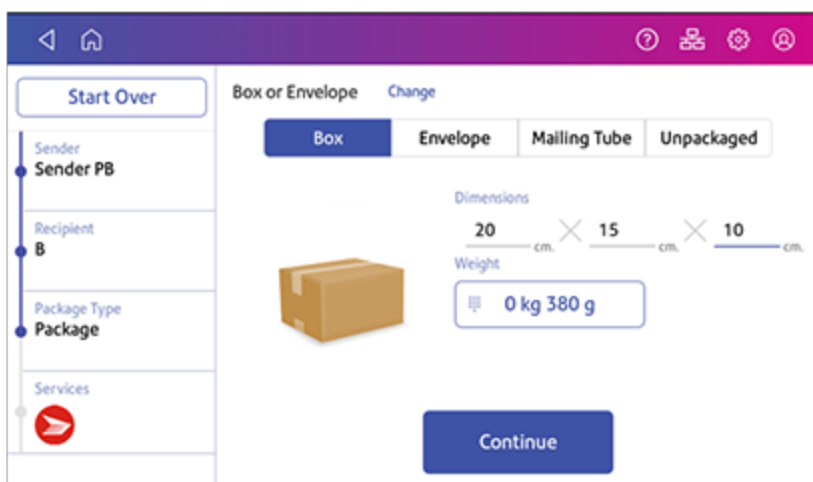

12. Tap the service you wish to use.

The screenshot shows a shipping configuration interface. At the top, there are navigation icons and a 'Start Over' button. Below this, a summary section shows 'Ship From This Postal Code MSE 152' and 'Ship Date Today'. A table lists shipping options with columns for Service, Arrival Date, and Price. The 'Regular Parcel' option is highlighted with a red border.

Service	Arrival Date	Price
Regular Parcel	Fri May 24 by end of day	\$12.46
Expedited Parcel	Wed May 22 by end of day	\$12.94
Xpresspost	Wed May 22 by end of day	\$15.66
Priority	Wed May 22 by end of day	\$29.44

13. To add extra services, tap **Add additional services**. If you are not adding any extra services, go to step 14.

This screenshot shows the same shipping configuration interface as the previous one, but with the 'Add additional services' button highlighted in red. The 'Regular Parcel' service is now selected, and its price is updated to \$11.03. A 'Print' button is visible at the bottom left.

Service	Arrival Date	Price
Regular Parcel	Fri May 24 by end of day	\$11.03
Add additional services		
Expedited Parcel	Wed May 22 by end of day	\$12.94
Xpresspost	Wed May 22 by end of day	\$15.66
Priority	Wed May 22 by end of day	\$29.44

14. Select the desired extra services and tap **Apply** when done.

15. Tap **Print**.
16. At the Label Options screen, tap **Format** and select the printer format.

17. (Optional) To print a sample label, tap **Print Sample**.
18. Tap **Print** again. The label prints.
- You may need to enter the Sender and Recipient's phone number (required for some services).
19. The carrier screen reappears. You can now print another label.

Printing postage on envelopes

The Print on Envelopes app is the starting point for printing postage on an envelope or a tape. It also allows you to change what you print.

To open the Print on Envelopes screen, tap **Print on Envelopes** on the Home screen.

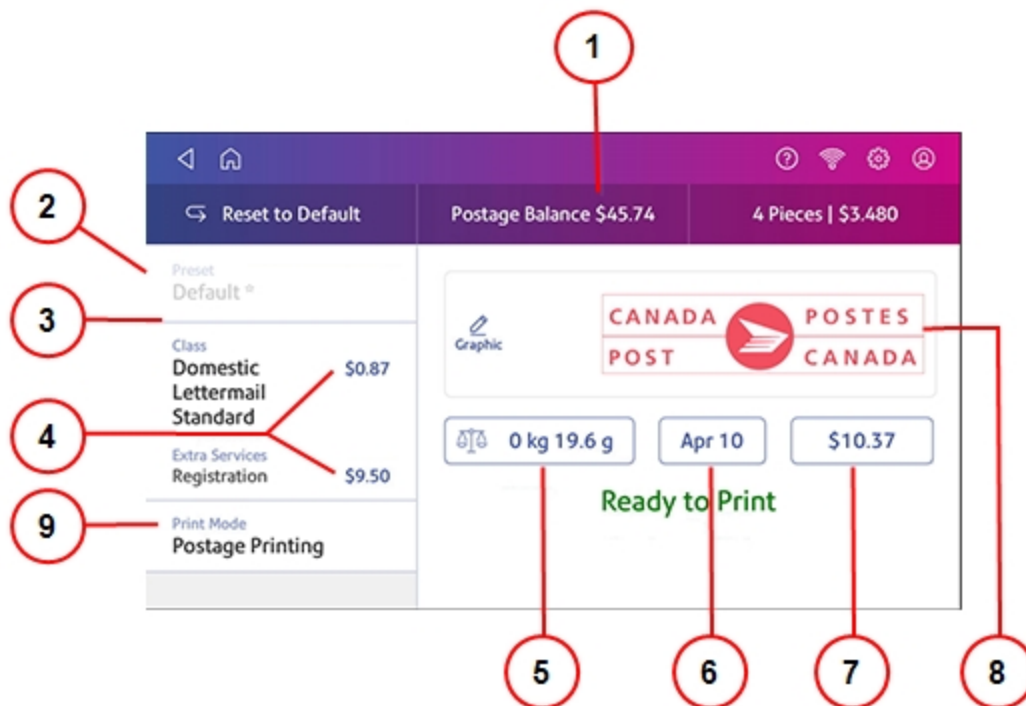

On this screen, you can:

1. View the balance of funds you have remaining in your device.
2. Select a Preset for your letter.
3. Select an account by tapping **Account** (this option appears if your device has the account feature enabled).
4. Tap **Class** to view the class and any extra services.
5. Tap the weight icon to view the weighing options (enter weight manually or using a scale).
6. Tap the date to view the date options.
7. View the total postage amount.
8. Preview or add graphics.

9. Tap **Print Mode** to access the Print mode screen. This provides you with different printing modes such as adding graphics to your envelope, adding more postage, or making corrections to the date. You can also choose to only seal envelopes without printing any postage.

Sending a Lettermail™ envelope

Lettermail is an economical way to send mailpieces through Canada Post.

1. Tap **Print on Envelopes** on the Home screen.
2. If you have the accounting feature enabled, tap **Account** and select an account.
3. Tap **Class**.
4. Tap **Start Over** to display a list of all the available classes.
5. Tap **Domestic Lettermail** for a Lettermail envelope.
6. Tap **Standard**.
7. Tap **Apply**.
 - With a scale:
 - a. Place the envelope on the scale.
 - b. The weight appears.
 - Without a scale:
 - a. Tap **Weight**.
 - b. Enter the weight of the envelope.
 - c. Tap **Apply**.
8. Tap **Extra Services**.
9. Select special services, if required.
10. Tap **Apply**.
11. Place the envelope or envelopes on the feed deck. Depending on the SendPro C model you have, feed the envelopes manually or tap **Start** to feed the envelopes.

Note: Your device will upload transactions if you have previously printed any mail. Once the upload completes, you see the message "Transaction upload status, Upload success" with a check mark. Tap the check mark.

Using Canada Post special services

1. Tap **Print on Envelopes** on the Home screen.
2. If you have the accounting feature enabled, tap **Account** and select an account.

3. Tap **Class**.
4. Tap the class you wish to use. Sub-classes appear when available for the selected class.
5. Tap **Apply**.
 - With a scale:
 - a. Place the envelope on the scale.
 - b. The weight appears.
 - Without a scale:
 - a. Tap **Weight**.
 - b. Enter the weight of the envelope.
 - c. Tap **Apply**.
6. Tap **Extra Services**.
7. Select any special services you wish to use.
8. Tap **Apply**.
9. Place the envelope or envelopes on the feed deck. Depending on the SendPro C model you have, feed the envelopes manually or tap **Start** to feed the envelopes.

Adding a graphic to your envelope in Print on Envelopes

Your device comes with a set of standard graphic images that you can add to your envelopes or tapes when you print your postage. Graphic ads are also known as ads, slogans or logos. Examples include PLEASE OPEN IMMEDIATELY, RECYCLE, and Holiday Greetings.

Note: At this time, you cannot add your own custom graphics to your SendPro C Lite, SendPro C, SendPro+ device.

1. Weigh your envelope, select a class, and select any special services required.
2. Tap the **Graphic** icon on the Print on Envelopes screen.
3. Select the desired graphic.
4. Tap **Apply**.
5. To verify that the envelope prints correctly, feed the envelope through the device.

Using the scale when printing postage

Use the scale to weigh your mail and calculate the correct postage for you.

1. Tap **Print on Envelopes** on the Home screen.
2. Tap **Weight**.

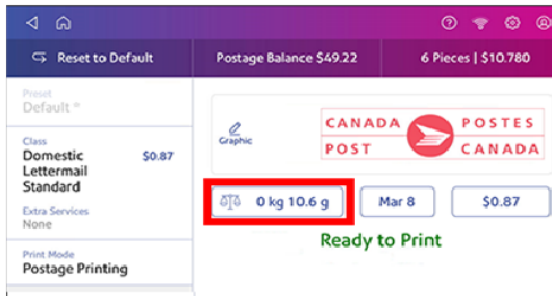

3. Tap **Scale**.
4. Place the envelope on the scale. You must do this before the next step or else the **Apply** button remains inactive.
5. Tap **Apply**.
6. Tap **Class**.
7. Select **Start Over** to show the class options.
8. Tap the class you want.
9. Select special services, if required.
10. Tap **Apply**.
11. Place the envelope or envelopes on the feed deck. Depending on the SendPro C model you have, feed the envelopes manually or tap **Start** to feed the envelopes.
12. The scale retains the weight of the mail for approximately 70 seconds. Add another mailpiece to the scale if you want to override the weight.

Sealing envelopes when you print postage

You can seal envelopes and print postage at the same time with your SendPro C Lite, SendPro C, SendPro+.

1. Check the level of sealing solution in the moistener tank. Add more if required.
2. Slide the envelope flap under the edge of the feed deck so the moistener can wet the flap.

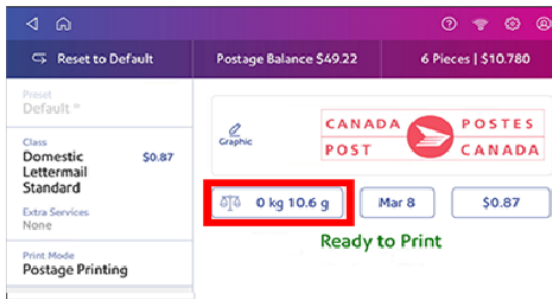

3. Tap **Print on Envelopes** on the Home screen.
4. Tap **Account** and select an account if accounting is enabled on your device.

5. Tap **Weight**.6. Tap **Scale**.

7. Place the envelope on the scale. You must do this before the next step or else **Apply** remains inactive.
8. Tap **Class** then select the class of mail you want.
9. Tap **Graphic** then select a graphic, if necessary.
10. Tap **Apply** to continue.
11. Insert the envelope into the device. The device prints the postage .

Important: If the moistener tank is full and your envelopes do not seal correctly, clean or replace the moistener brush and wick.

Sealing envelopes without printing postage

Use Seal Only mode to seal envelopes without printing anything.

1. Tap **Print on Envelopes** on the Home screen.
2. Tap **Print Mode**. You may need to swipe up on the screen to see this option.
3. Select **Seal Only**.
4. Tap **Apply**.

5. Place your envelope face up, flap down into the feeder. Be sure to slide the envelope flap under the edge of the feed deck.



6. Insert the envelope into the device. The device seals the envelope.



Filling the moistener tank

Your device will need refills of E-Z Seal® in order to seal envelopes. Follow these steps to fill the moistener tank.

1. Check the level of E-Z Seal® in your moistener tank (1).

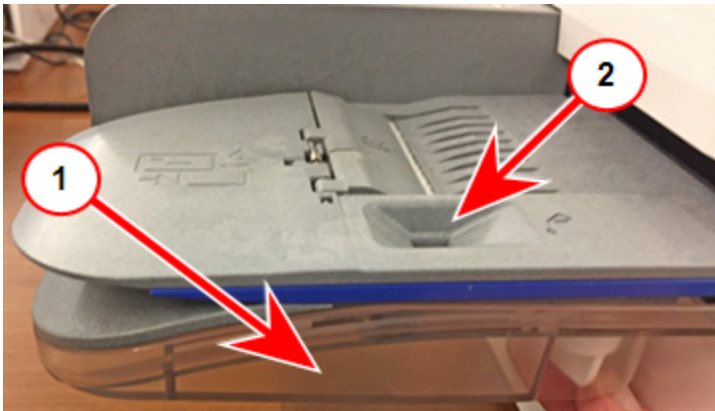

2. Add enough E-Z Seal® to bring the sealant level up to the bottom of the fill hole (2). Do not overfill the tank.
3. If the tank is empty, allow 30 minutes for the moistener brush and wick to get completely wet.

Replacing the ink cartridge

Replace the ink cartridge when the low ink warning appears. This ensures your device is in optimal working condition.

1. Tap **Settings**.



2. Scroll down and tap **Envelope Printer Maintenance**.
3. Tap **Install Ink**.
4. Lift the top cover. The ink cartridge moves to the front position.

5. Remove the ink cartridge, as shown on the label next to the cartridge holder.

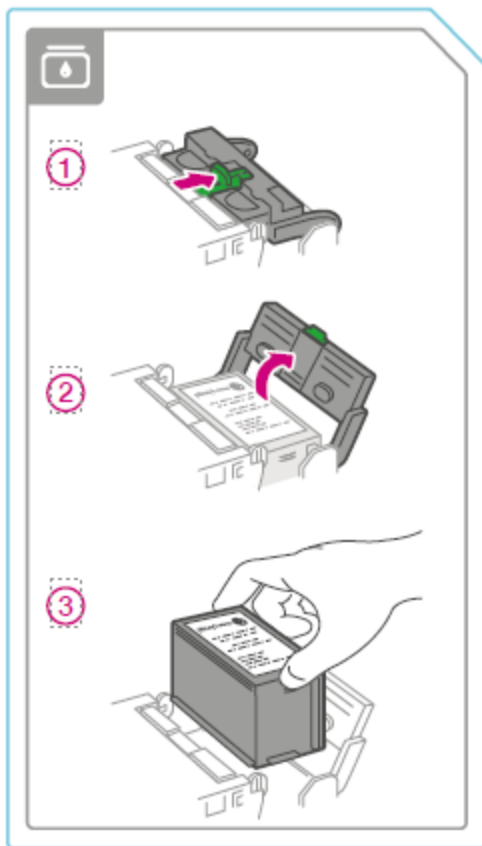

6. Insert the new ink cartridge, then close the ink cartridge guard.

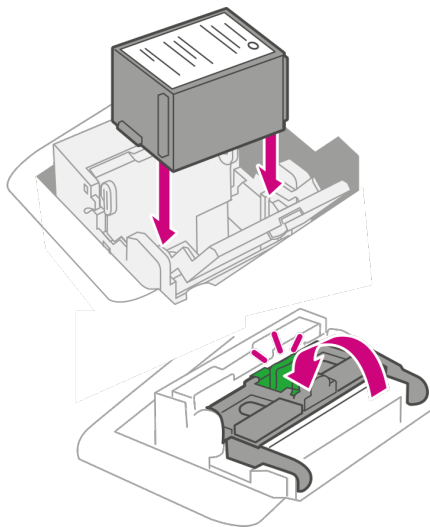

7. Close the top cover.

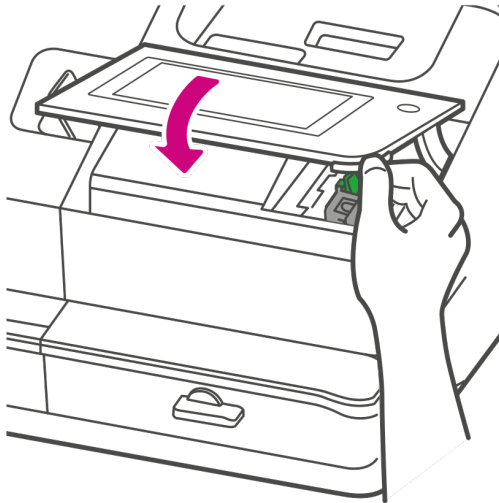

8. The cartridge repositions itself and the Envelope Printer Maintenance screen appears.
9. Print a test pattern to ensure that your ink cartridge installs properly.

Printing a test pattern

Print a test pattern to see if the printhead is working properly or if you have enough ink in the cartridge.

1. Tap **Settings**.



2. Scroll down and tap **Envelope Printer Maintenance**.
3. Tap **Print Test Pattern**.
4. Insert the envelope into the device when the message "Print a Test Pattern?" appears.

5. Examine the pattern printed on the envelope:
 - Tap **Done** if the lines are unbroken and match the "Good" test pattern shown on the display.
 - Tap **Clean Print Nozzle** if the test pattern has missing or incomplete lines
 - Once the cleaning operation completes, you must print another test pattern.
 - If this new pattern still has broken or missing lines, you may need to replace the ink cartridge or clean or replace the printhead.
 - If you see no improvement in print quality, do not repeat the cleaning, as cleaning the print nozzles consumes ink.

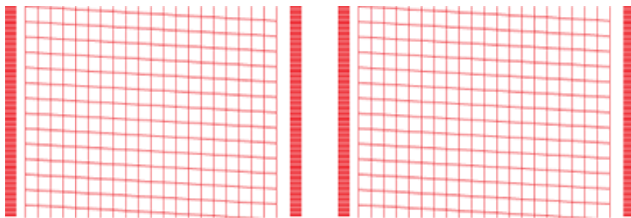

Good Test Pattern

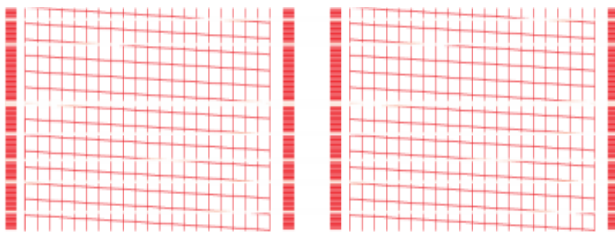

Bad Test Pattern

Supplies, ink cartridges, and options

Visit our [supplies website](#) to order supplies for your device.

2 - Connectivity

In this section

Setting up a wired network connection.....	31
Setting up a wireless (Wi-Fi) network connection.....	34
Connecting to a hidden Wi-Fi network.....	34
Forgetting a Wi-Fi network.....	36
Checking your network connection.....	38
Finding the MAC address for wired and wireless networks.....	39
Setting up a Proxy server.....	42

Setting up a wired network connection

Use a network cable to connect your device to the Pitney Bowes Data Center.

Step 1: Plug in your network cable

Plug one end of your network cable to your device and the other end to an internet jack on the wall or a router.

Step 2: Choose the connection type

Select one of the two connection types supported for this device:

- *DHCP*
- *Static IP*

DHCP is the most common connection type. Choose DHCP if you are unsure which connection protocol to use or contact your IT department for advice.

DHCP

1. Tap **Settings**.



2. Tap **Wired**.

3. Select **DHCP**.

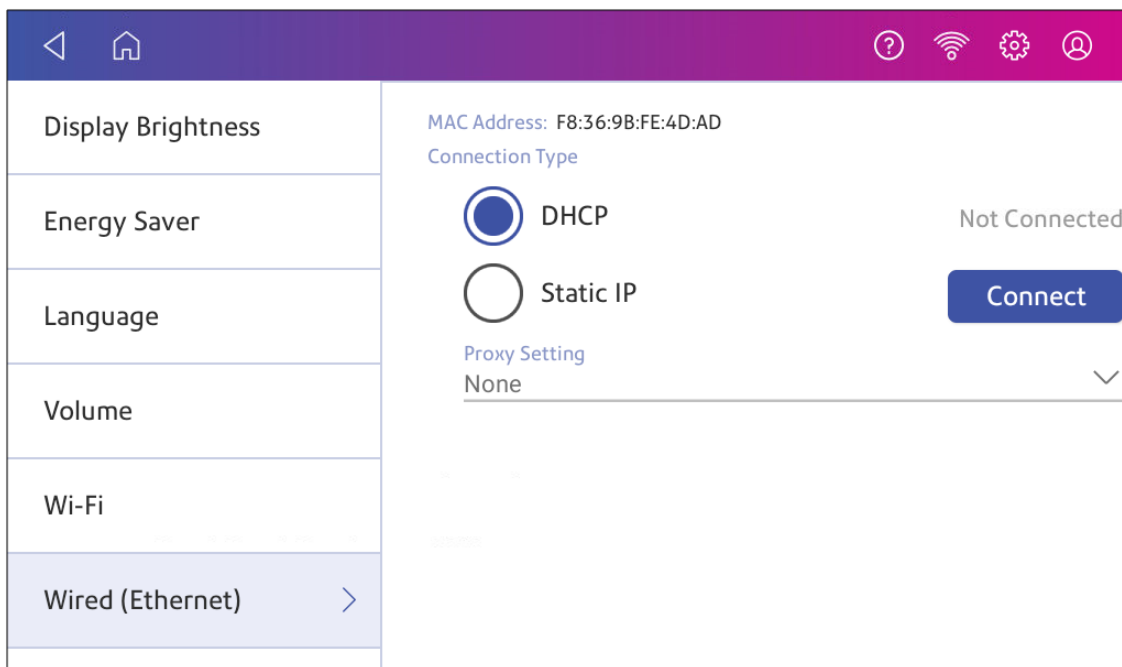

4. Tap **Connect**.
5. If it does not connect, unplug the power cord.
6. Wait 30 seconds. The screen should turn off after 10 seconds.
7. Plug the power cord back in directly into a wall outlet.
8. Quickly tap and release the power button to turn the device back on.
9. Tap **Settings**.



10. Tap **Wired (Ethernet)**.
11. Tap **DHCP**.
12. Tap **Connect**.

Static IP

1. Tap **Settings**.



2. Tap **Wired**.
3. Select **Static**.

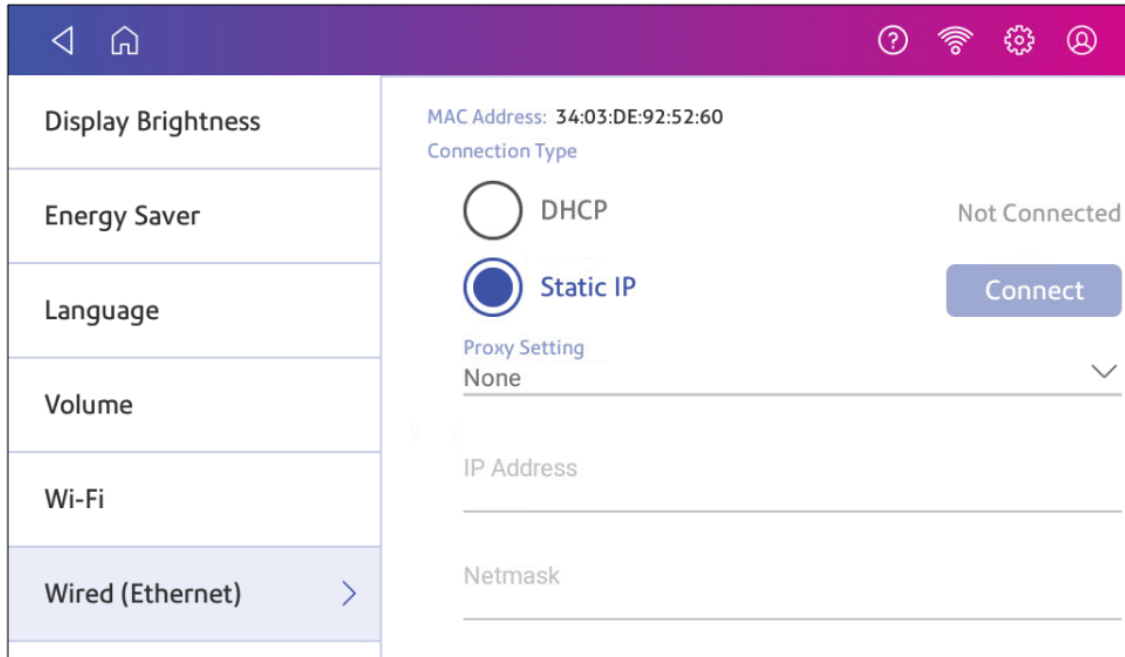

4. Contact your IT department to obtain the settings you will need to enter for your device. The values needed are:
 - **IP Address**
 - **Netmask**
 - **Gateway**
 - **DNS Address.**
5. Enter the settings you obtained in step 4 for the **IP Address**, **Netmask**, **Gateway**, and **DNS Address** in the corresponding fields.
6. Tap **Connect**.
7. If the device fails to connect, remove the network cable from the back of the device.
8. Tap **Connect**. Wait for the attempted connection to fail.
9. Plug the network cable back in.
10. Delete the values in the **IP Address**, **Netmask**, **Gateway**, and **DNS Address** fields.
11. Enter the **IP Address**, **Netmask**, **Gateway**, and **DNS Address** that you obtained in step 4.
12. Tap **Connect**.

NOTE: Your device will remember the Static IP information even if you switch back to DHCP and then back again. This information includes IP Address, Netmask, Gateway and DNS Address as well as the proxy information.

Setting up a wireless (Wi-Fi) network connection

You can connect your device with a wireless network connection.

1. Tap **Settings**.



2. Tap **Wi-Fi** in the Device & Network section.
3. Choose your Wi-Fi network from the list. Tap **Add Network** if your Wi-Fi network does not appear.
4. Enter your Wi-Fi password.
Tip: Use the show password option to make sure that you enter your password correctly.
5. Tap **Advanced Options** if your network requires advanced network settings such as a Static IP address:
 - To set up a Static IP address:
 - a. Select the **IP Setting** menu and choose **Static**.
 - b. Tap on the line and enter the value provided by your IT department.
 - c. Tap the > in the green circle.

Connecting to a hidden Wi-Fi network

Add a network when you want to connect using Wi-Fi and your network is not present in the Wi-Fi list.

1. Tap **Settings**.



2. Tap **Wi-Fi** in the Device & Network section to see a list of available networks.

3. Tap **Add Network** at the top of the Wi-Fi screen.

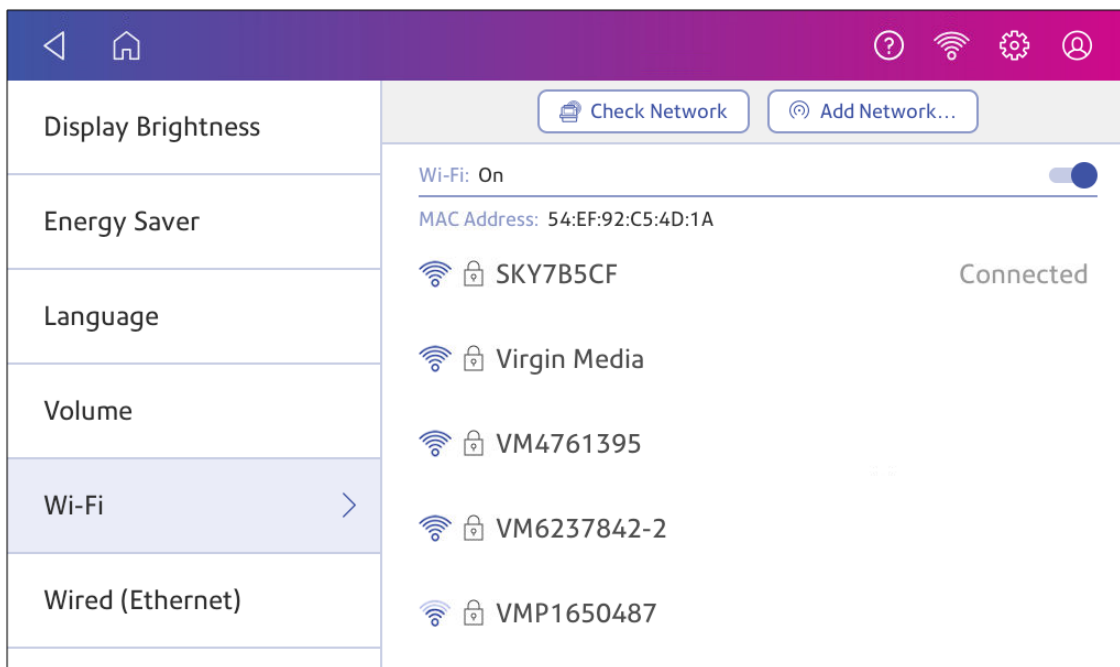

4. For each of the following steps, please consult with your IT department to obtain the necessary information.
 - a. Tap the down arrow in the Security field and select the security method.

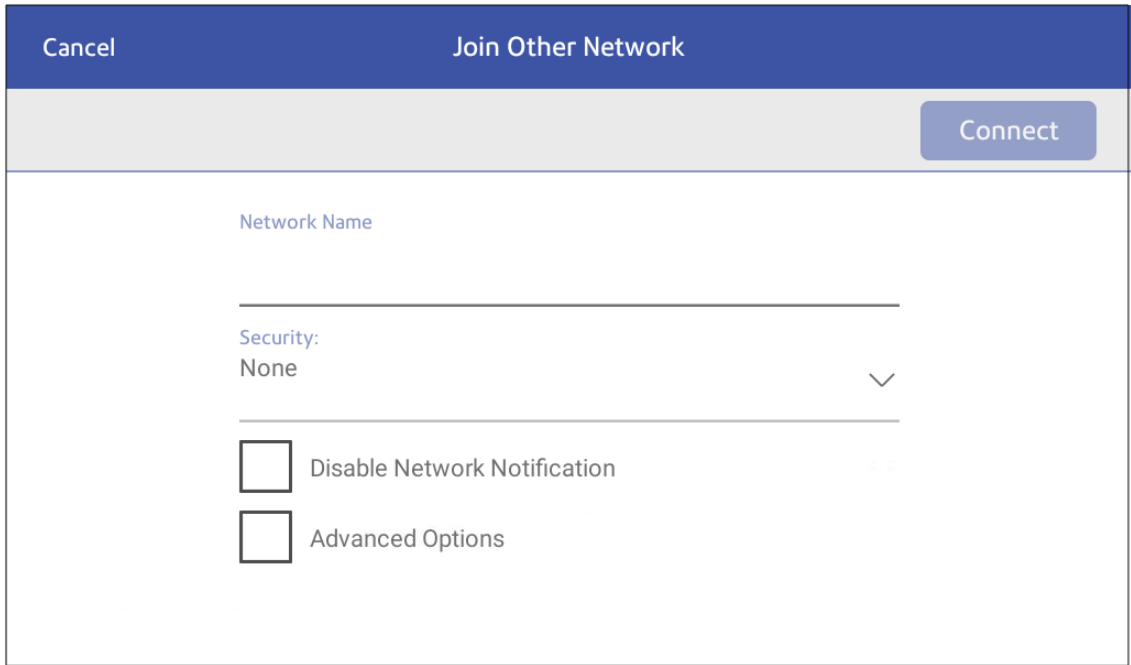

- b. Tap **Advanced Options** to enter a static IP or set up a proxy.
5. Tap **Connect** when done.

Forgetting a Wi-Fi network

Forget a Wi-Fi network if:

- You do not want your device to automatically connect to that network or
- You need to resolve a wireless network issue.

1. Tap **Settings**.



2. Tap **Wi-Fi** in the Device & Network section.

3. Tap the network you want to forget. You can only forget a network if you've connected to it before.

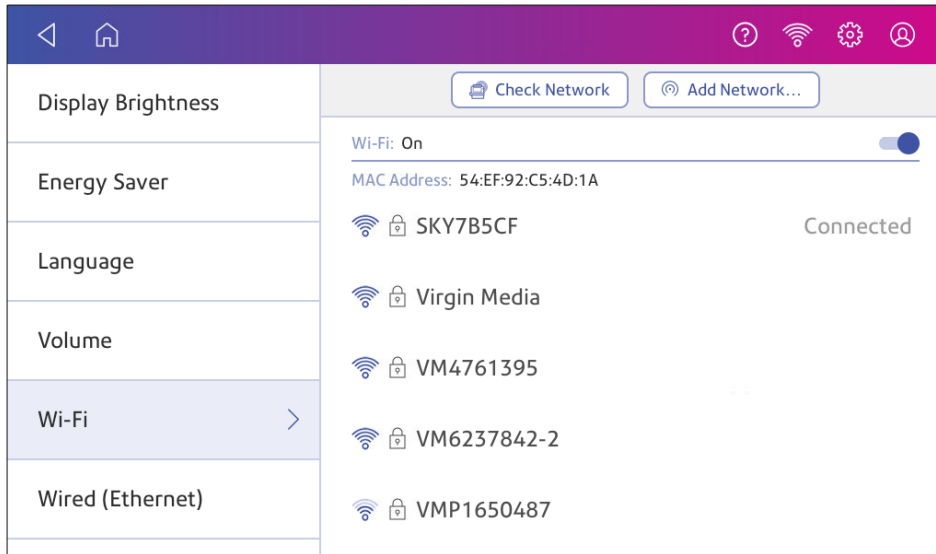

The network details appear.

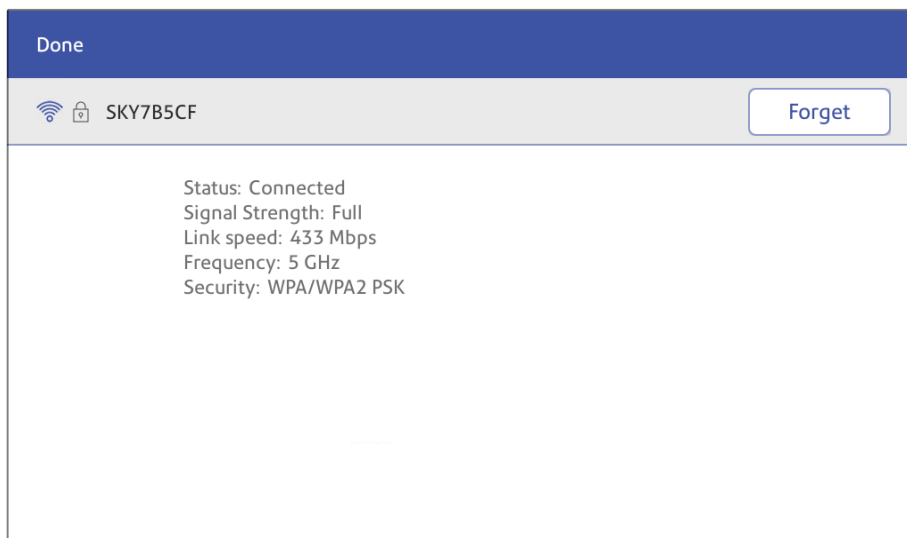

4. Tap **Forget** to forget the network connection.

Checking your network connection

Use the Network Connection app to check that you have the necessary internet services to connect to the internet. The app helps diagnose network connection issues.

Your IT department may be blocking certain services. Only they will know if the necessary services are available on your network.

1. To open and run the network checking app:
 - Tap **SendPro Apps** on the Home screen, then tap **Network Connection**.
2. The device then provides you with the results of the network check.
3. Tap **Close** twice to return to the Home screen.

If you are unable to connect to the internet, ask your IT department or internet provider to check the internet settings before you contact Pitney Bowes.

Finding the MAC address for wired and wireless networks

The MAC address is the network identifier for the device. IT uses it to allow the device onto the network.

Your device contains two MAC addresses: One for wireless connections and one for wired connections.

Locating the MAC address for wireless connections

1. Tap **Settings**.



2. Tap **Wi-Fi**.
3. The MAC address appears above the list of wireless networks.

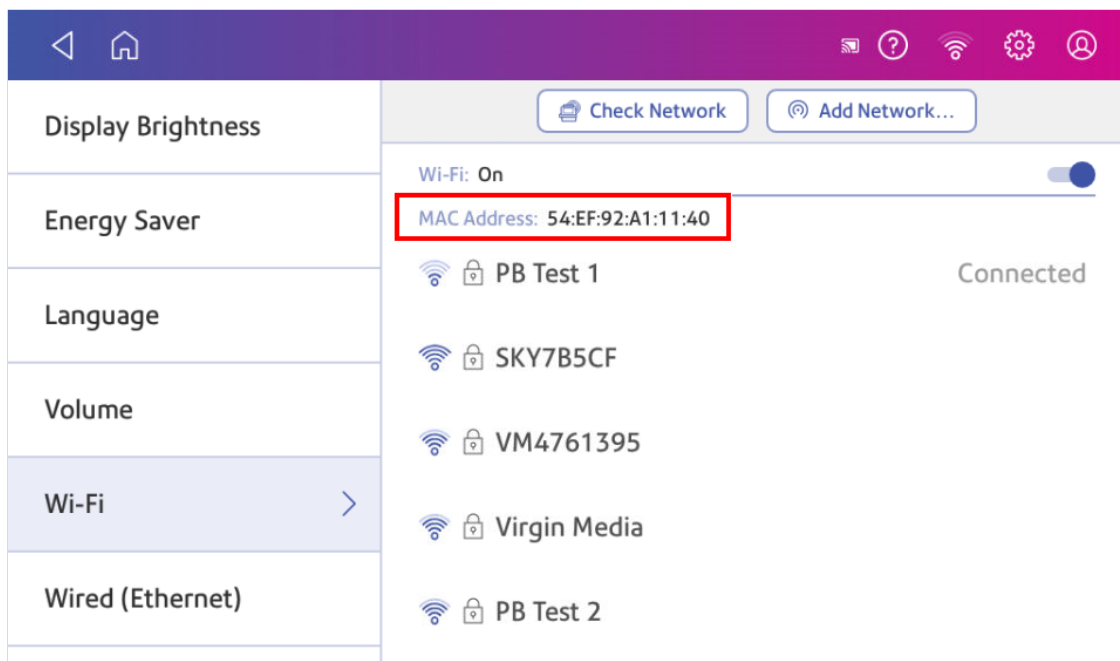

Locating the MAC address for wired connections

1. Tap **Settings**.



2. Tap **Wired (Ethernet)**. The MAC address is present at the top of the screen.

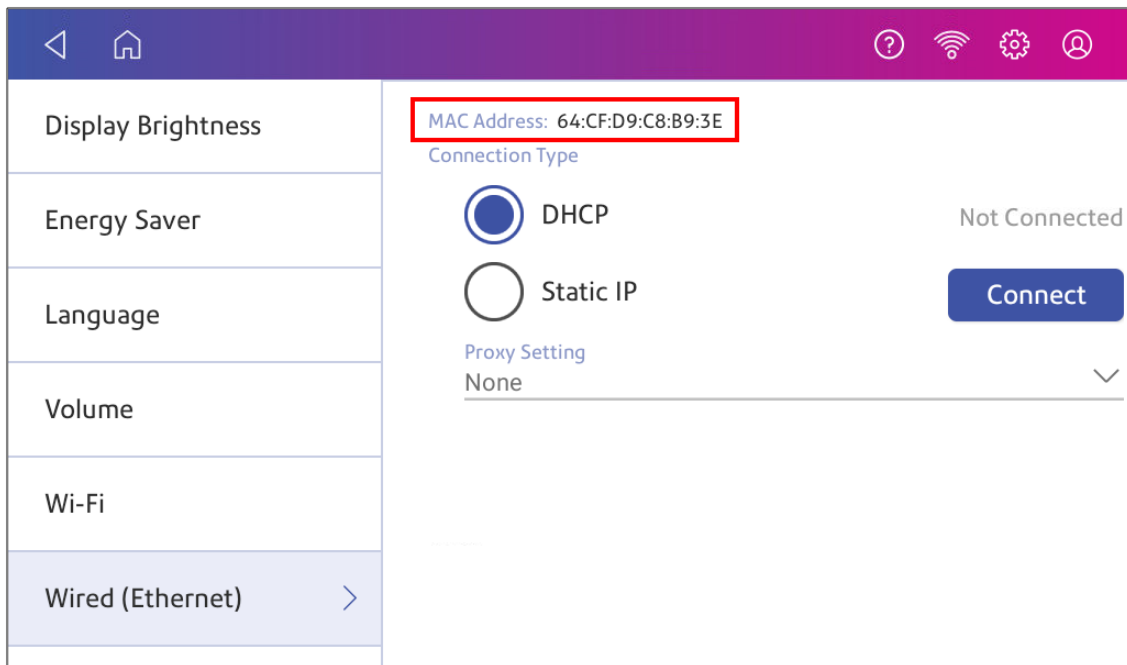

3. Tap **Check Network**. The Checking Network Connection screen appears.

4. Tap **View Details** in the Connected to wired network box when the test finishes.

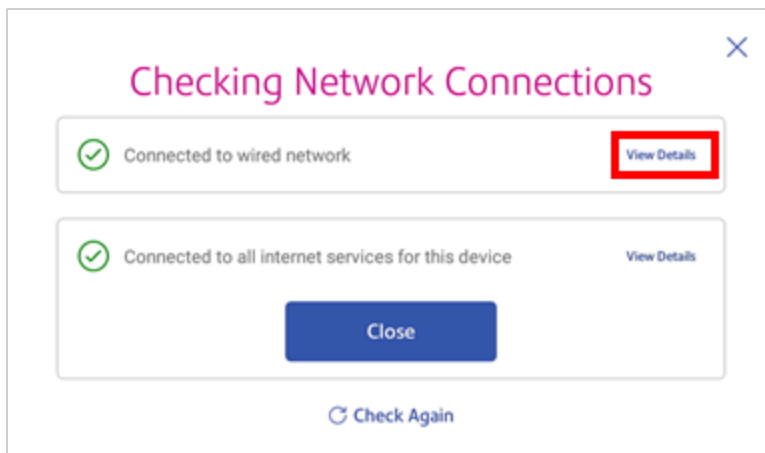

The MAC address appears:

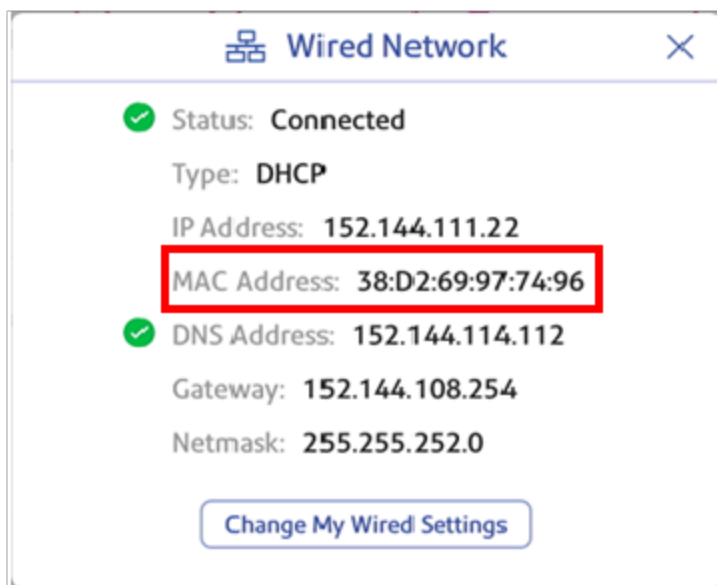

5. Tap **X** to close this window.
6. Tap **Close**, then the **back arrow** to return to the Home screen.

If the MAC address does not appear, try these steps:

1. Tap **Settings**.



2. Scroll down to the Advanced Device Options section and tap **About this C-Series**.
3. Scroll down to the Base Network Info section to locate the MAC Address.

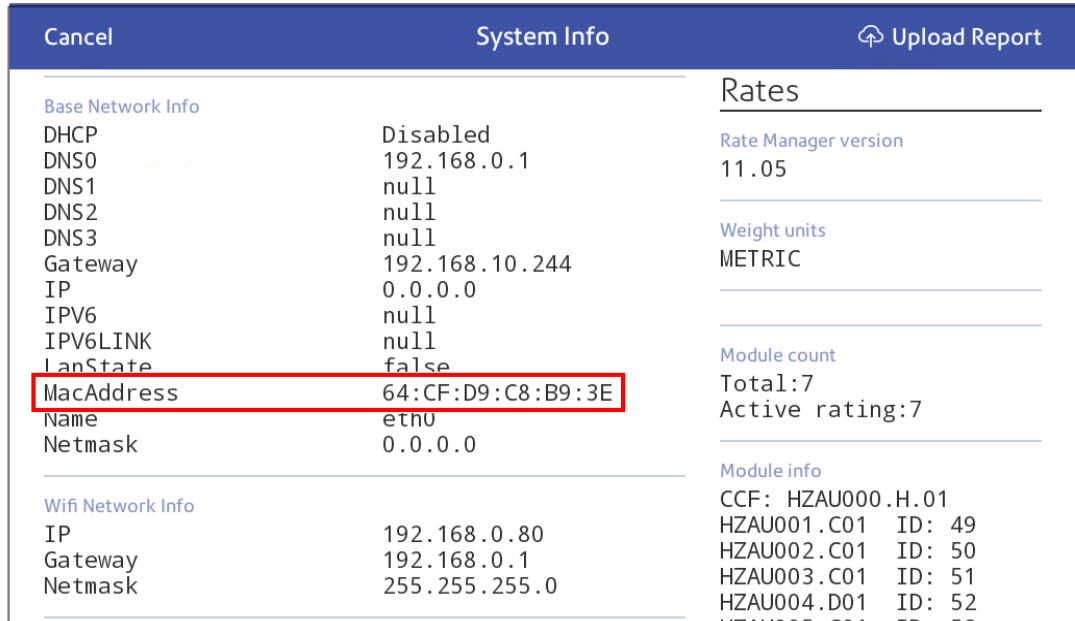

4. Tap **Cancel** to return to the Home screen.

Setting up a Proxy server

A Proxy server is a computer that acts as a gateway between your local network, your device, and the internet. Proxy servers provide increased performance and security.

If your network requires a proxy server, you must contact your IT department or service provider to obtain the proxy server information to set up a proxy server.

Choose the connection type

Choose how you connect your device to set up a Proxy server:

- [Setting up a Proxy server using a Wi-Fi network connection](#)
- [Setting up a Proxy server using a wired network connection](#)

Setting up a Proxy server using a Wi-Fi network connection

1. Tap **Settings**.



2. Tap **Wi-Fi** in the Device & Network section.
3. Select the network from the list.
4. Tap on the **Advanced Options** checkbox to select it.
5. Scroll down and tap the arrow next to Proxy, then select **Manual**.

A screenshot of the 'Wireless Network' settings screen on an iPhone. The screen has a blue header with 'Cancel' on the left and 'Wireless Network' in the center. Below the header, there is a grey bar with a Wi-Fi icon, a lock icon, and the network name 'VM4761395'. On the right side of this bar is a 'Connect' button. Below the grey bar, there is a section for 'Advanced Options' with a checked checkbox. Underneath, there is a 'Proxy' dropdown menu currently showing 'Manual'. Below the dropdown are three text input fields labeled 'Proxy Hostname', 'Proxy Port', and 'Bypass (example1.com,example2.com)'. The bottom of the screen is partially obscured by a keyboard.

6. Enter the IP address, HTTP or HTTPS proxy address of your proxy server in the **Proxy Hostname** field.
7. Enter the port number for the proxy server in the **Proxy Port** field.
8. (Optional) Enter any specific URLs or URL patterns (such as internal addresses) that you wish to bypass the proxy in the **Bypass** field.

9. If your Proxy Server requires authentication, select the **Need Authentication** check box. Additional fields appear.
 - a. Enter the Proxy username in the **Proxy Username** field. This may be case sensitive for some proxy servers.
 - b. Enter the Proxy password in the **Proxy Password** field. This is case sensitive for proxy servers.

Setting up a Proxy server using a wired network connection

1. Tap **Settings**.



2. Tap **Wired (Ethernet)** in the Device & Network section.
3. Select either **DHCP** or **Static IP**.
4. If you select DHCP, tap on the drop-down arrow next to Proxy Setting and select **Manual**.

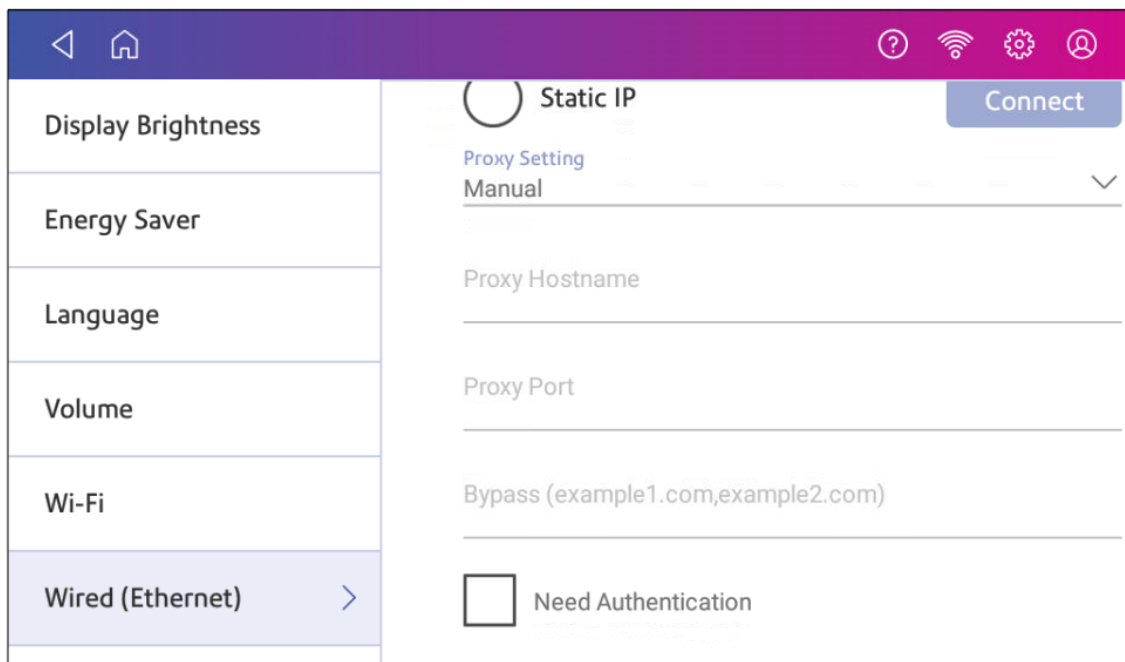

5. Enter the IP address, HTTP or HTTPS proxy address of your proxy server in the **Proxy Hostname** field.
6. Enter the port number for the proxy server in the **Proxy Port** field.

7. (Optional) Enter any specific URLs or URL patterns (such as internal addresses) that you wish to bypass the proxy in the **Bypass** field.
8. If your Proxy Server requires authentication, select the **Need Authentication** check box. Additional fields appear.
 - a. Enter the Proxy username in the **Proxy Username** field. This may be case sensitive for some proxy servers.
 - b. Enter the Proxy password in the **Proxy Password** field. This is case sensitive for proxy servers.

3 - Scales and Weighing

In this section

Installing a scale.....	47
Using the scale when printing postage.....	47
Entering the weight manually when printing postage.....	48
Zeroing the scale.....	49

Installing a scale

Install a scale if you did not install one when you installed your device. Your device contains step-by-step installation instructions for compatible scales.

1. Tap **Settings**.



2. Scroll to the Advanced Device Options section at the bottom of the Settings screen, then tap **Scale Installation Guides**.
3. To view all the available scales, swipe to the left on the screen.

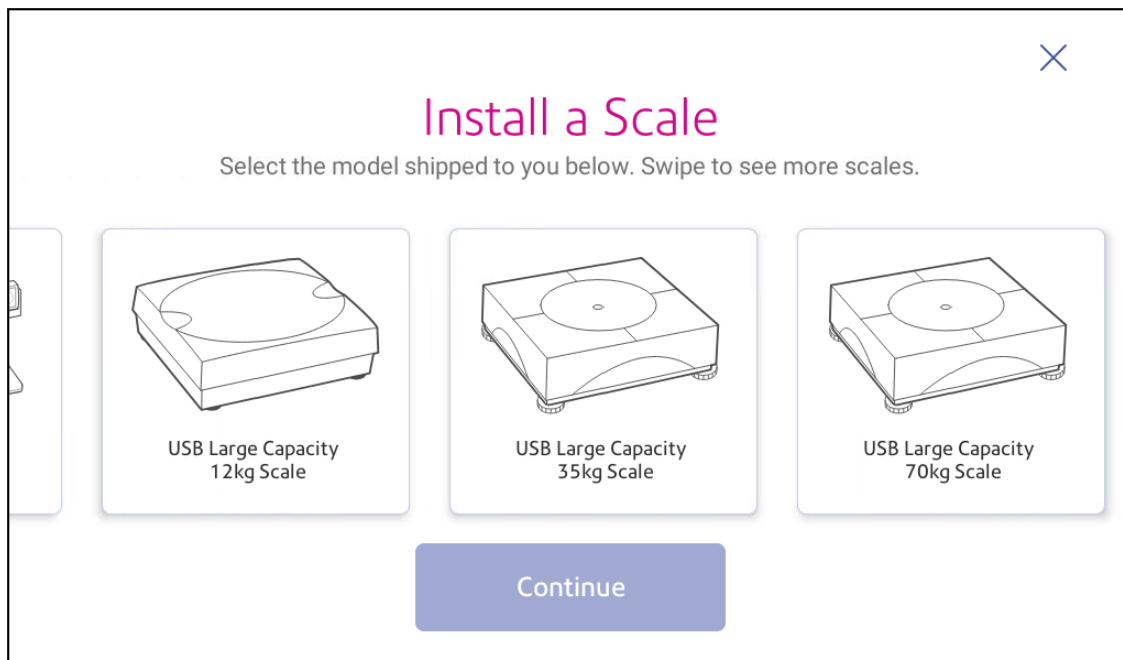

4. Tap to select the appropriate scale, then tap **Continue**.
5. Follow the instructions on the screen. To advance to the next step, swipe the screen to the left.

Using the scale when printing postage

Use the scale to weigh your mail and calculate the correct postage for you.

1. Tap **Print on Envelopes** on the Home screen.
2. Tap **Weight**.

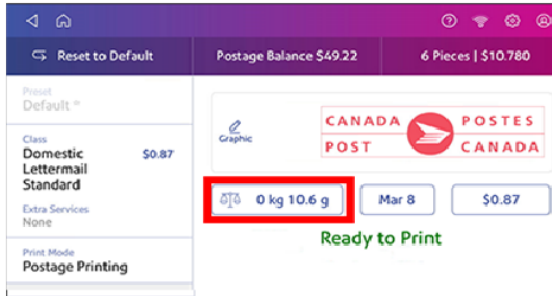

3. Tap **Scale**.
4. Place the envelope on the scale. You must do this before the next step or else the **Apply** button remains inactive.
5. Tap **Apply**.
6. Tap **Class**.
7. Select **Start Over** to show the class options.
8. Tap the class you want.
9. Select special services, if required.
10. Tap **Apply**.
11. Place the envelope or envelopes on the feed deck. Depending on the SendPro C model you have, feed the envelopes manually or tap **Start** to feed the envelopes.
12. The scale retains the weight of the mail for approximately 70 seconds. Add another mailpiece to the scale if you want to override the weight.

Entering the weight manually when printing postage

Enter the weight of a mailpiece when you know its weight and are not using the scale.

1. Tap **Print on Envelopes** on the Home screen.
2. Tap **Weight**.

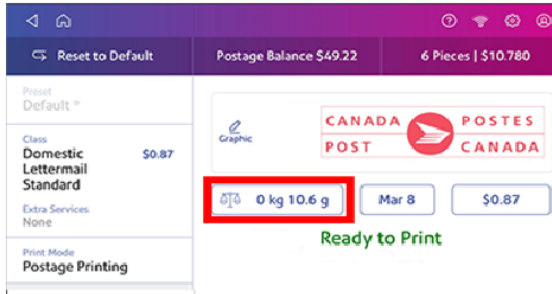

3. Tap **Manual**.
4. Enter the **kilograms** and **grams**.
5. Tap **Apply**.
6. Tap **Class**.
7. Tap **Start Over** to see all the class options.
8. Select the class and any special services required.
9. Tap **Apply**.
10. Place the envelope or envelopes on the feed deck. Depending on the SendPro C model you have, feed the envelopes manually or tap **Start** to feed the envelopes.

Zeroing the scale

Zero the scale to set the weight to zero.

Make sure there is nothing on the scale when you zero it.

Scales and Weighing

1. Tap **Print on Envelopes** on the Home screen.
2. Tap **Weight**.

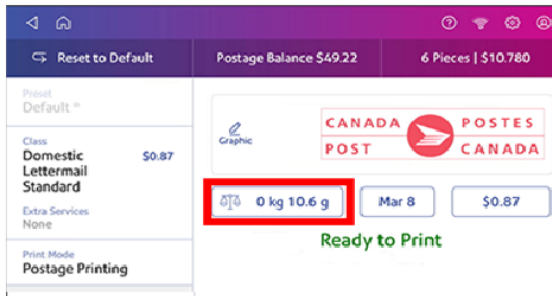

3. Tap **Scale** on the weighing method screen.
4. Tap **Zero Scale**.
5. Tap **Cancel** to return to the Print on Envelopes app.

4 - Accounting

In this section

What is Accounting.....	52
Adding a Print on Envelopes account.....	53
Turning Print on Envelopes account passwords on or off for printing postage.....	54
Editing an account.....	55
Deleting a Print on Envelopes account.....	56
Emailing an account report.....	57

What is Accounting

You can use the accounting feature to track the postage that departments or individuals within your organization use.

The accounting feature helps you to understand how your business spends its postage and identify cost-saving opportunities. You can charge postage back to departments or clients and report on postage expenditures.

When you use Print on Envelopes accounts to track your postage usage, use sub accounts and sub sub accounts to analyze your usage within an account.

How you create accounts depends on your needs. You can create accounts in single or multiple levels. For example, you can divide a top level department (account) into two additional sub sections (sub accounts and sub sub accounts).

The Print on Envelopes accounting structure can have up to a three level hierarchy:

- account (top level of the hierarchy)
- sub account (next possible level of the hierarchy)
- sub sub account (last possible level of the hierarchy)

Important: Only the lowest level of the account hierarchy is chargeable. This means that the lowest level of the account has the transactions applied to them.

- **Account with no sub accounts** - When you create an account with no sub accounts, you charge postage to that account. This is because the account does not have sub or sub sub accounts.
- **Account with sub account or sub sub account** - When you create a sub account or sub sub account, you charge postage to the lowest level (the sub account or sub sub account).

Account hierarchy examples

Top level account

- Engineering

Account with sub accounts

- Engineering; Sub account - Software;
- Engineering; Sub account - Hardware;

Account with sub sub accounts

- Engineering; Sub account - Software; Sub sub account - Graphics and Layout; Sub sub account - Design
- Engineering; Sub account - Hardware; Sub sub account - Quality Approval; Sub sub account - Testing

Adding a Print on Envelopes account

You can add a Print on Envelopes account to track your costs for printing postage on envelopes. This is different from your PB account which is used to fund your postage or shipping label costs.

Accounting is a feature that is optional and needs enabling if you want to use it. Contact your Pitney Bowes Sales Representative for information about options and pricing.

1. Tap **Print on Envelopes** on the Home screen.
2. Tap **Account** and select an account if accounting is enabled on your device.
3. Tap **Preferences** in the upper right corner of the screen.



4. Tap **Manage Accounts**.
5. Tap **Create new account**.
6. Tap **Create a new account** for a new account.
7. Enter the account name in the Enter account name field. Account names can be up to 75 characters long.

If the keyboard does not pop up, tap the line in the gray box.



8. Enter a unique code in the Code field to identify each account. Codes can be alphanumeric. Codes help you locate accounts more easily.

9. You can use the optional fields, such as:
 - **Description** - Enter a description of the account up to 150 characters.
 - **Password** - Tap **Password** to add a password for an account.
 - Passwords are case sensitive, can be alphanumeric, and must be four characters in length. If you do set a password, you need to enter it to print mail.
10. Ensure you set the status to active.
11. Tap anywhere on the screen outside of the fields when complete.
12. Tap **OK** to save. The name of the new account appears.
 - Tap **Create New Account** to create another account.
 - Tap **Add a Sub Account to this account** to add a sub account to the account you just created.
 - Tap **Done** if you do not need to create any more accounts.
13. Press the **back arrow** to return to the account list.

Turning Print on Envelopes account passwords on or off for printing postage

You can protect each account from unauthorized access by turning account passwords on.

1. Tap **Print on Envelopes** on the Home screen.
2. Tap **Account**.
3. Tap **Preferences**.

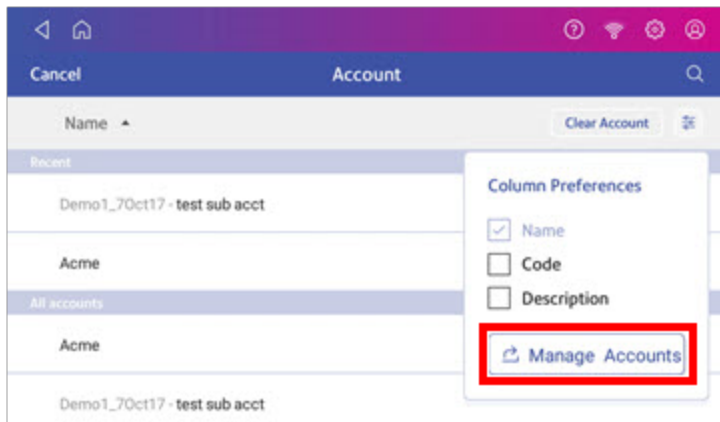

4. Tap **Manage Accounts**.

5. The Manage Accounts screen opens.

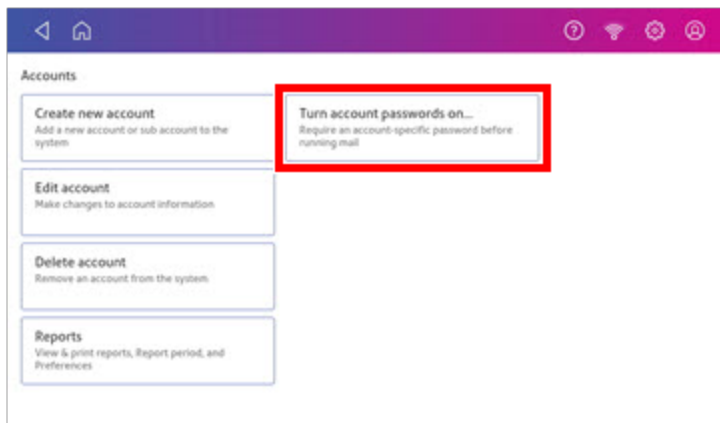

- Tap **Turn account passwords on** if account passwords are off and you wish to turn them on. Tap **OK**.
 - Tap **Turn account passwords off** if account passwords are on and you wish to turn them off. Tap **OK**.
6. Tap the back arrow on the top left side of the screen to return to the list of accounts.
 7. Tap **Cancel** to return to the Mail screen.

Editing an account

Edit an account when you want to change the account name, code, description, status or password.

Important: Once you charge postage to an account, you cannot change the account name or code.

1. Tap **Print on Envelopes** on the Home screen.
2. Tap **Account**.
3. Tap **Preferences**.



4. Tap **Manage Accounts**.
5. Tap **Edit account**.
6. Tap the account you want to edit.
7. Select **OK**.
8. Make your changes, such as edit the account name, code, description, status or password.
9. When finished, tap anywhere on the screen outside of the fields.
10. Tap **OK** to return to the Accounts screen.
11. Tap the back arrow to return to the list of accounts.
12. Tap **Cancel** to return to the Print on Envelopes screen.

Deleting a Print on Envelopes account

You can delete an account, sub account, or sub sub account through the Print on Envelopes app.

If you apply postage to an account, you cannot delete the account. You can only make the account inactive.

1. Tap **Print on Envelopes** on the Home screen.
2. Tap **Account**.
3. Tap **Preferences**.



4. Tap **Manage Accounts**.
5. Tap **Delete account**. The list of available accounts appears.
6. Tap the account you want to delete.
7. Tap **OK**.

8. Tap **Yes, delete account** to confirm.
9. Tap **OK**.
10. Tap the back arrow to return to the list of accounts.
11. Tap **Cancel** to return to the Print on Envelopes app.

Emailing an account report

Email an account report to keep a record of how much departments or clients have spent on their postage over specific time periods.

1. Tap **Print on Envelopes** on the Home screen.
2. Tap **Account**.
3. Tap **Preferences**.



4. Tap **Manage Accounts**.
5. Tap **Reports**.
6. Tap **View & print reports**.
7. Tap the report to select it.
8. Tap **Next**.
9. Tap **Actions** or **View Reports** at the bottom of the screen.

10. Tap **Email Report**.

The screenshot shows the Accounting app interface. At the top, there is a purple header bar with navigation icons (back, home, help, menu, settings, profile). Below the header, the 'Period:' section displays 'Current Period' with 'Start: 01-05-22' and 'End: 31-05-22'. The 'Meter(PSD):' section displays '1H20-8000018'. Below these sections, there are four buttons: 'Save as', 'Save', 'Delete report', and 'Print report'. The 'Email Report' button is highlighted with a red border. At the bottom, there is a bar with 'Actions ▲', 'Cancel', 'Back', and 'View report' buttons.

11. Tap in the **Please enter the recipient mail address** box and enter the recipient's email address. The email address you enter will remain until you turn off then turn on the device.

The screenshot shows the Accounting app interface for the 'Email Report' screen. At the top, there is a purple header bar with navigation icons (back, home, help, menu, settings, profile). Below the header, there is a red-bordered box containing the text '* Please enter the recipient mail address:' and an empty text input field. Below this, there is a section titled '* Attach report as file type:' with three radio button options: '.xlsx', '.csv', and '.pdf'. At the bottom, there is a bar with 'Cancel' and 'Send' buttons. A note '* Required fields' is visible at the bottom left of the form area.

12. Tap the file type you wish to send: **xlsx** (Excel), **csv** (comma-separated values), **pdf** (Portable Data Format).
13. Tap **Send**. The report appears from no-reply@pb.com.

5 - Postage Funding

In this section

Checking the available funds for printing postage.....	61
Refilling postage funds for printing postage.....	63
Viewing receipts for refilling postage for Print on Envelopes.....	64
Changing the default refill amount for printing postage.	64
Viewing the postage refill history.....	65
Checking your PitneyWorks® balance.....	65
Getting a Canada Post refund for damaged or incorrectly printed mail in Print on Envelopes.....	66
Viewing the total spent on printing postage.....	66
Setting the low funds warning for printing postage.....	67

Checking the available funds for printing postage

Check your funds for printing postage on your device at any time.

Viewing the amount available in your device

1. Tap **Print on Envelopes** on the Home screen.
2. The **Postage Balance** shows the available funds in your device.

Viewing the amount available in your postage account at Pitney Bowes

1. Tap **Print on Envelopes** on the Home screen.
2. Tap **Postage Balance**.
3. Tap **Settings**.
4. The balance in your postage account appears.

Refilling postage funds for printing postage

Refill your postage funds for printing postage as soon as you receive a message that your funds are low.

Before you begin

Check that your device is connecting to the internet.

- For wired network connections, you will see the following connection image in the toolbar:



- If you have a wireless connection, you will see the following connection image in the toolbar:



To refill postage:

1. Tap **Print on Envelopes** on the Home screen.
2. Tap **Postage Balance**.
3. Tap **Refill Postage**.
4. Enter the postage refill amount.
5. Tap **back** to change the amount shown.



6. Tap **Refill Mail Postage**.

7. Tap **View Receipt** to view or print a receipt.
8. Tap **Done**. Your updated postage balance appears on the Print on Envelopes app.

Viewing receipts for refilling postage for Print on Envelopes

You can view receipts for all the times when you have refilled postage for your Print on Envelopes account.

1. Tap **SendPro Apps** on the Home screen, then tap **Print Refill Receipt**.
2. Tap **Refill History**.
3. From the Refill History screen, tap the date of the refill you want to view.

Changing the default refill amount for printing postage

Change the default refill amount to store an amount you want to refill your device with.

You can set the default refill amount during installation or change it at later time.

There are two ways to change the default refill amount:

From the Home Screen:

1. Tap **Settings**.



2. Scroll down to the Envelope Printer Settings section.
3. Tap **Postage Refills**.
4. Tap the box under **Default refill amount**.
5. Tap the back key to remove the existing amount. You may need to tap the key multiple times to clear the amount.
6. Enter the new amount.
7. Tap **Apply**.
8. Tap the back arrow to return to the Home screen.

From Print on Envelopes:

1. Tap **Print on Envelopes** from the Home screen.
2. Tap **Postage Balance**.
3. Tap **Refill Settings**.
4. Tap the box under **Default refill amount**.
5. Tap the back key to remove the existing amount. You may need to tap the key multiple times to clear the amount.
6. Enter the new amount.
7. Tap **Apply**.
8. If necessary, tap the back arrow to return to the Print on Envelopes app.

Viewing the postage refill history

You can view a report showing all your past postage refills.

1. Tap **SendPro Apps** on the Home screen.
2. Tap **Print Refill Receipt**.
3. Tap the **Refill History** report in the Print on Envelopes Reports section.
4. Tap on a postage refill to open a refill receipt.

Important: At this time, you can only view the report.

Checking your PitneyWorks® balance

Your PitneyWorks balance for printing Canada Post Trackable Labels appears on the Feedback bar of the Mail screen.

1. Tap **Print on Envelopes**.
2. Tap **Postage Balance**.

3. Tap **Refill Settings**. The balance appears on the right-hand side of the screen.

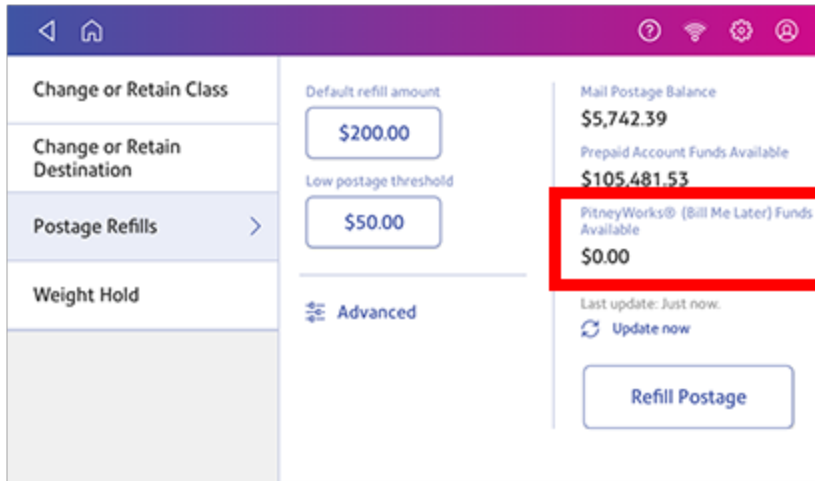

Getting a Canada Post refund for damaged or incorrectly printed mail in Print on Envelopes

You may be eligible for a refund from Canada Post based on current Canada Post [postal regulations](#). Refer to [How do I get a refund for spoiled meter impressions](#).

Important: Refunds are issued solely at the discretion of Canada Post. Pitney Bowes has no authorization to give refunds for misprinted, damaged, or printed and unused postage.

For more information, contact your local [corporate Canada Post office](#).

Viewing the total spent on printing postage

View the total amount you have spent on postage and the total number of pieces printed.

1. Tap **Settings**.



2. Scroll down to the Envelope Printer Settings section.

3. Tap **Postage Refills**.
4. Tap **Advanced** to view the total amount of postage spent and the number of pieces printed.

Setting the low funds warning for printing postage

Set the low funds warning to warn you when your available funds for printing postage reaches a certain amount. Use this warning as a reminder to add more postage to your device.

1. Tap **Print on Envelopes** on the Home screen.
2. Tap **Postage Balance**.
3. Tap **Refill Settings**.
4. Tap **Low postage threshold**.
5. Tap **back** on the keypad to remove the existing amount.
6. Enter the new amount.
7. Tap **Apply**.
8. If necessary, tap the back arrow to return to the Print on Envelopes app.

6 - Mailing and Shipping

In this section

Printing a shipping label.....	69
Printing an international shipping label.....	75
Reprinting a Canada Post, UPS or FedEx shipping label.....	75
Printing a Canada Post return shipping label.....	76
Getting a Canada Post refund for a shipping label.....	76
Adding a shipping label cost account.....	77
Sending a Lettermail™ envelope.....	78
Using Canada Post special services.....	79
Key in Postage.....	79

Printing a shipping label

Use Create Shipping Labels to get the best pricing, free tracking, and detailed delivery history for Canada Post package services. You can also send via UPS® or FedEx®. The packaging options and benefits are almost identical.

1. Tap **Create Shipping Labels** on the Home screen.

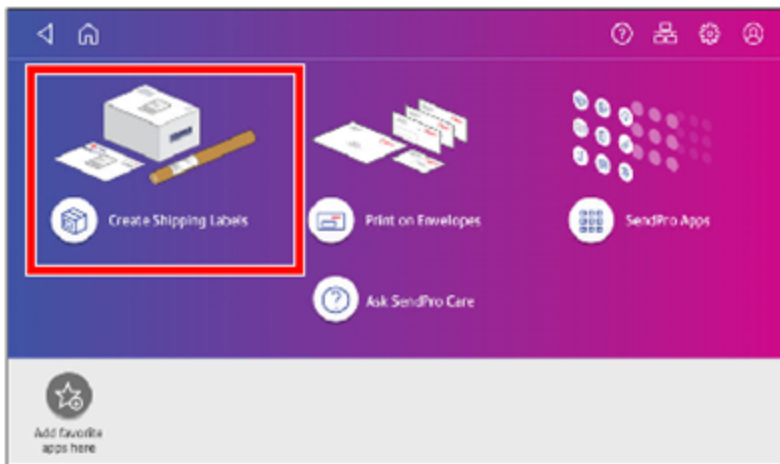

2. Tap the carrier you wish to use.

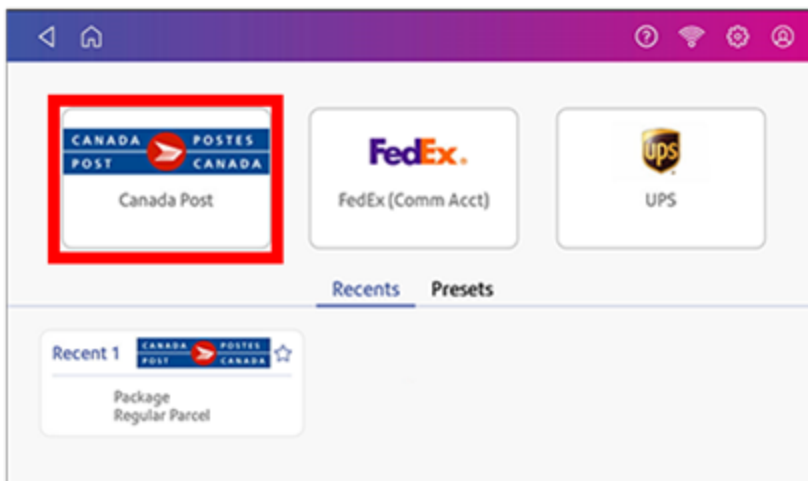

3. Verify that the sender address is correct. If not, tap on the **Sender** field and select a new address.

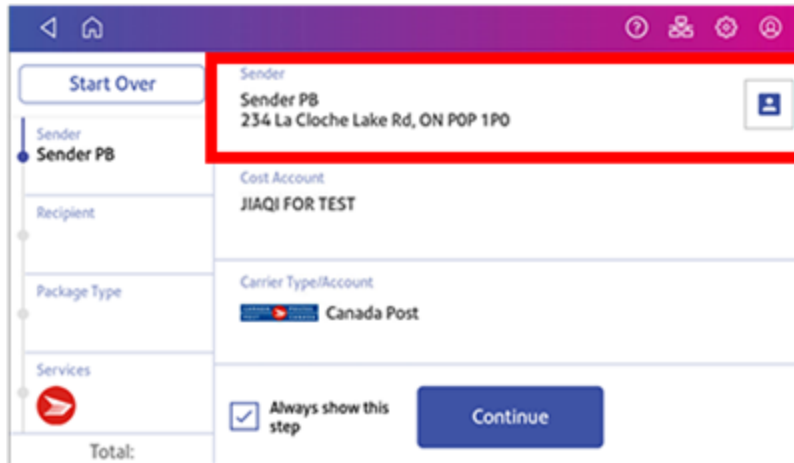

4. If you have enabled cost accounts on your SendPro C Lite, SendPro C, SendPro+, you must provide an account. If this field contains an account, verify the account is correct. To change or add an account, tap on the **Cost Account** field and select an account from the list.
5. Tap **Continue**.

6. Enter the recipient address.
 - a. You can manually enter the recipient information or select one from the address book. To select one from the address book, tap the address book icon in the upper right corner of the screen.

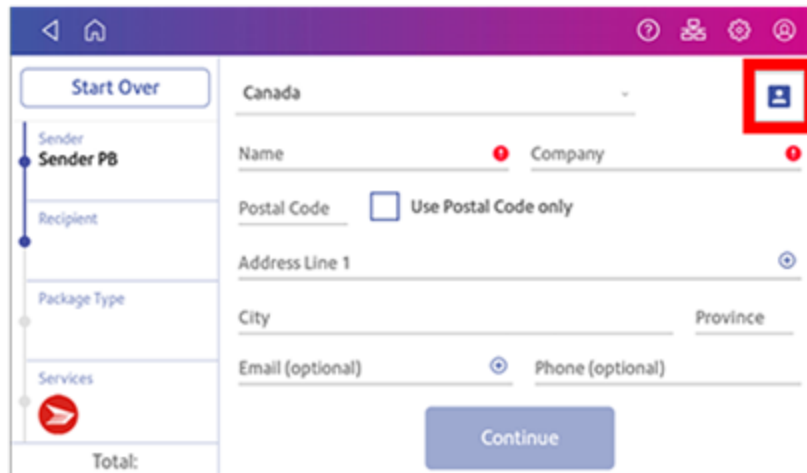

The screenshot shows a mobile application interface for creating a shipping label. On the left, there is a vertical navigation menu with options: 'Start Over', 'Sender', 'Recipient', 'Package Type', and 'Services'. The 'Sender' section is currently selected, showing 'Sender PB'. The main area is titled 'Canada' and contains several input fields: 'Name' and 'Company' (both with red error indicators), 'Postal Code' (with a checkbox for 'Use Postal Code only'), 'Address Line 1', 'City', and 'Province'. There are also optional fields for 'Email' and 'Phone'. A 'Continue' button is at the bottom right. A red box highlights the 'Address Book' icon in the top right corner.

- b. For Canada Post domestic shipments, if your package already has an address, you can select the **Use Postal Code only** box and enter the postal code to create the label without entering the address.

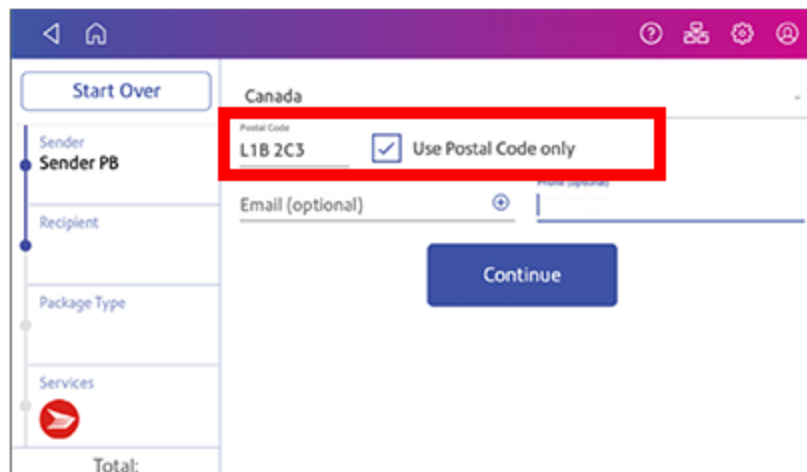

This screenshot shows the same shipping label creation screen as above, but with the 'Use Postal Code only' checkbox checked. The 'Postal Code' field now contains the value 'L1B 2C3'. A red box highlights the 'Postal Code' field and the 'Use Postal Code only' checkbox.

7. Tap **Continue**.

8. Tap a package type.

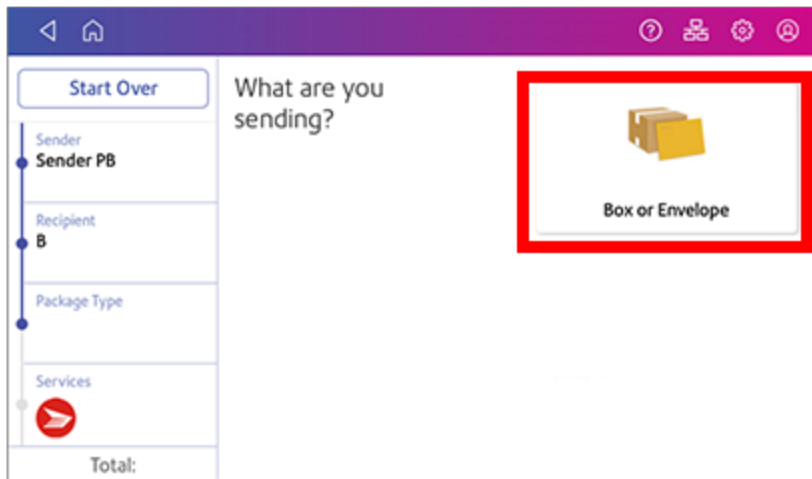

9. Enter the dimensions and the weight of the box or envelope:
 - Tap each dimension and enter a value using the display keypad. Tap the green check mark when done.
10. Enter the weight:
 - If you have an attached scale, tap **Weight**, then select **Scale**. Place the box or envelope on the scale.
 - If you do not have a scale, tap on the **Weight** field, enter the value using the keypad, then tap **Apply**.
11. Tap **Continue**.

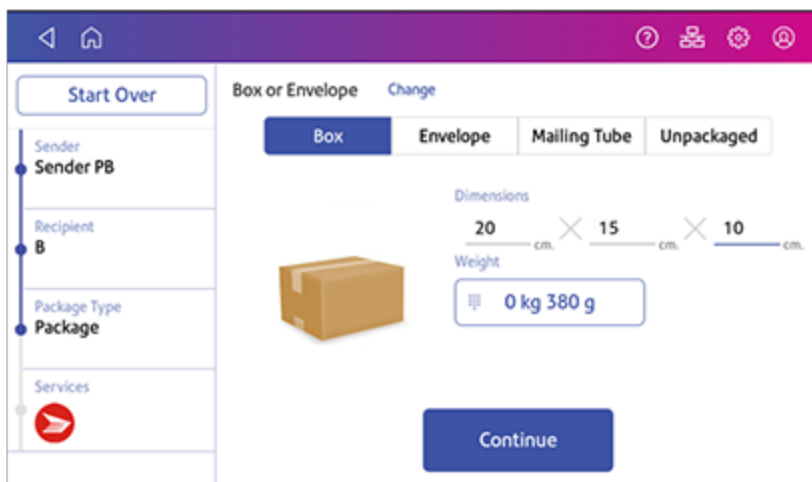

12. Tap the service you wish to use.

Sender	Service	Arrival Date	Price
Customer Care	Regular Parcel	Fri May 24 by end of day	\$12.46
Recipient B	Expedited Parcel	Wed May 22 by end of day	\$12.94
Package Type Package	Xpresspost	Wed May 22 by end of day	\$15.66
Services	Priority	Wed May 22 by end of day	\$29.44

13. To add extra services, tap **Add additional services**. If you are not adding any extra services, go to step 14.

Sender	Service	Arrival Date	Price
Customer Care	Regular Parcel	Fri May 24 by end of day	\$11.03
Recipient B	Add additional services		
Package Type Package	Expedited Parcel	Wed May 22 by end of day	\$12.94
Services Regular Parcel	Xpresspost	Wed May 22 by end of day	\$15.66
	Priority	Wed May 22 by end of day	\$29.44

Total: \$12.46

Print

14. Select the desired extra services and tap **Apply** when done.



15. Tap **Print**.

16. At the Label Options screen, tap **Format** and select the printer format.

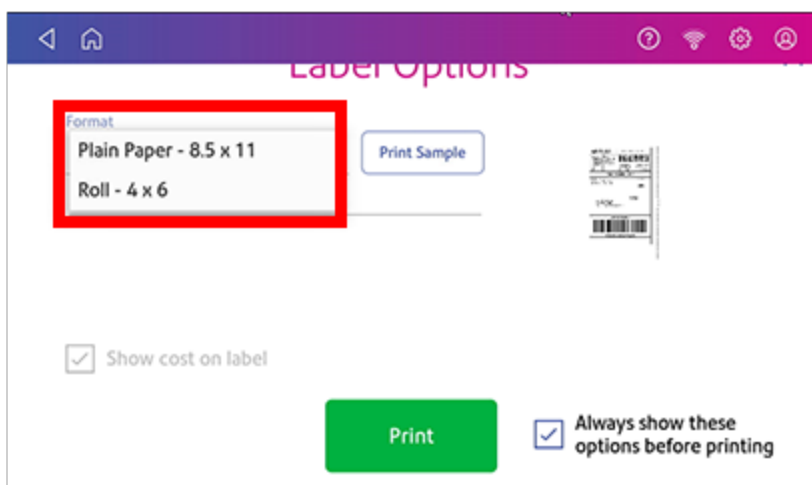

17. (Optional) To print a sample label, tap **Print Sample**.

18. Tap **Print** again. The label prints.

- You may need to enter the Sender and Recipient's phone number (required for some services).

19. The carrier screen reappears. You can now print another label.

Printing an international shipping label

Creating an international trackable label is almost the same as creating a domestic trackable label. The main difference is adding the information required for customs purposes. You must declare package contents for Canadian customs when shipping internationally and to military mail.

Important: In order to print an international label, you need to connect your SendPro C Lite, SendPro C, SendPro+ to an 8.5 x 11 1E50 laser printer. You can also print an international label from your PitneyShip Pro account using any 8.5 x 11 printer.

After you have recorded the weight of the package, enter the customs information.

This includes:

- Types of items in your shipment (documents, gifts or merchandise). Select either **Abandon** or **Return to Sender** if the item cannot be delivered.
- Description for each item, where the item was made, the quantity of the items. To enter the description, tap **Add an item**.
- Enter optional HS Tariff information if appropriate. You can look up HS Tariff numbers at the [Canada Post website](#).
- Enter where the item was made.

To add additional items, tap **Save and Add**. Tap **Save** when complete.

Once you have completed these steps, follow the same steps used to create and print a domestic shipping label.

Reprinting a Canada Post, UPS or FedEx shipping label

If a label does not print correctly, you can print it again.

1. Tap **SendPro Apps** on the Home screen, then tap **Shipping History**. All of the shipping labels appear by date. The most recent date appears first in the list.
2. Locate your label in the list. To sort by a different column, tap that column heading. To reverse the sort order, tap the same column heading again.
3. Tap on the shipment.
4. Tap **Reprint Label**.

Printing a Canada Post return shipping label

If you need to provide a Canada Post return label for someone to ship something back to you, you can print a return label.

1. Tap **SendPro Apps** on the Home screen, then tap **Shipping History**. All of the shipping labels appear by date. The most recent date appears first in the list.
2. Find your label in the list or by using the search box.
3. Tap on the shipment.
4. Tap **Create Return Label**.
5. Tap **Continue** through the screens to confirm the Sender and Recipient name and address.
6. If necessary, confirm the size and weight of the item.
7. Continue with Printing a shipping label.

Getting a Canada Post refund for a shipping label

You can request a refund up to 30 days from the date on which you first printed a shipping label. When you request a refund for Canada Post shipping labels, your postage balance receives a credit for the postage amount.

You can only void a label for domestic shipments. For international or U.S. shipments, you must request the refund through [Canada Post](#).

The refund process can take up to 20 days because Canada Post wishes to see if it can detect your shipment in its mailstream before crediting your account.

Note: When you cancel a UPS or FedEx shipping label you will not receive a credit. Instead, the postage will not appear on your UPS or FedEx invoice.

To request a refund for a shipping label you've just printed:

1. On the Carrier screen you will see a confirmation of the label print.
2. Tap **Request Refund**.

To request a refund from the History screen:

1. Open the History screen:
 - Tap **History** at the bottom of the Home screen, or,
 - Tap **SendPro Apps** on the Home screen, then tap **Shipping History**.
2. Tap **History** on the Home screen.
3. All the shipping labels appear in date order. The latest date appears first in the list.
4. Locate your label in the list. To sort by a different column, tap that column heading.
5. Tap on the shipment.
6. Tap **Request Refund**.
7. Select the agree box to agree to the conditions and then tap **Continue**.

Adding a shipping label cost account

Add shipping Cost Accounts to record shipping label usage by department.

1. Tap **SendPro Apps** on the Home screen, then tap **Cost Accounts** to open the Shipping Cost Accounts app.
2. Tap **+** in the upper left corner of the shipping Cost Accounts screen.
3. Enter the account name, up to 20 characters. Tap **Enter** when done.

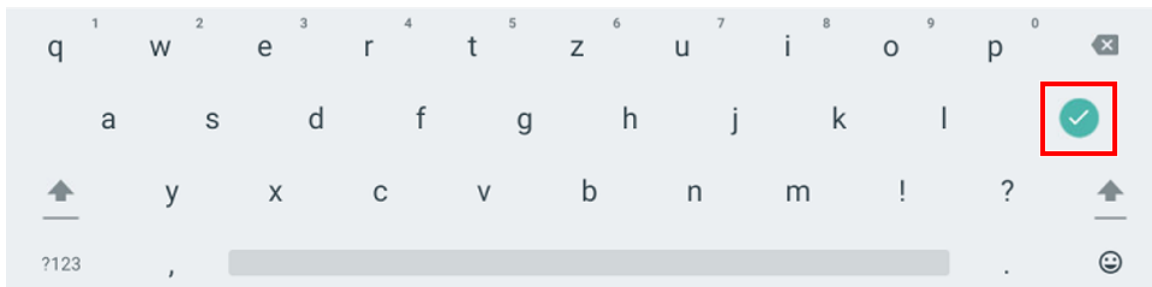

You can use lower case letters, upper case letters, numerals and special characters for the account name. Acceptable special characters include:

- - hyphen
 - _ dash
 - ' single quote
 - @ at sign
 - . Period
 - and optional description.
4. (Optional) Enter a description of the account up to 200 characters.

5. Tap **Enter** when done. You can use the same types of characters as for the account name.

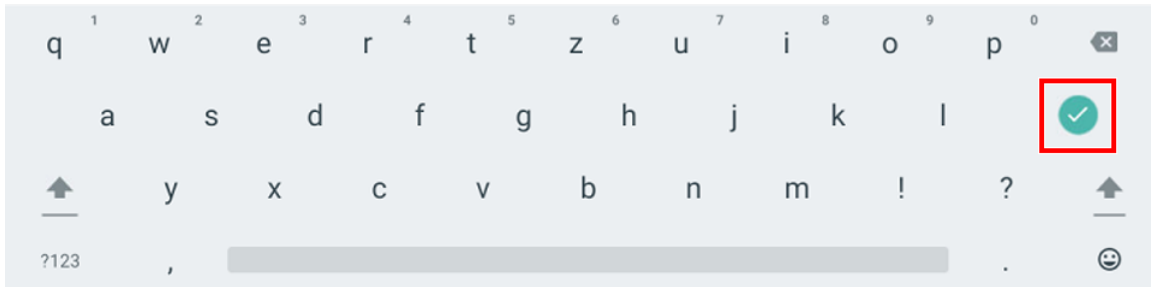

6. Tap **Active** or **Inactive**. Your selection should be whichever is appropriate for this account.
7. Tap **Make this my default Cost Account** to make this cost account automatically used for all shipping labels.
8. Tap **Apply**.

Sending a Lettermail™ envelope

Lettermail is an economical way to send mailpieces through Canada Post.

1. Tap **Print on Envelopes** on the Home screen.
2. If you have the accounting feature enabled, tap **Account** and select an account.
3. Tap **Class**.
4. Tap **Start Over** to display a list of all the available classes.
5. Tap **Domestic Lettermail** for a Lettermail envelope.
6. Tap **Standard**.
7. Tap **Apply**.
 - With a scale:
 - a. Place the envelope on the scale.
 - b. The weight appears.
 - Without a scale:
 - a. Tap **Weight**.
 - b. Enter the weight of the envelope.
 - c. Tap **Apply**.
8. Tap **Extra Services**.
9. Select special services, if required.
10. Tap **Apply**.

11. Place the envelope or envelopes on the feed deck. Depending on the SendPro C model you have, feed the envelopes manually or tap **Start** to feed the envelopes.

Note: Your device will upload transactions if you have previously printed any mail. Once the upload completes, you see the message "Transaction upload status, Upload success" with a check mark. Tap the check mark.

Using Canada Post special services

1. Tap **Print on Envelopes** on the Home screen.
2. If you have the accounting feature enabled, tap **Account** and select an account.
3. Tap **Class**.
4. Tap the class you wish to use. Sub-classes appear when available for the selected class.
5. Tap **Apply**.
 - With a scale:
 - a. Place the envelope on the scale.
 - b. The weight appears.
 - Without a scale:
 - a. Tap **Weight**.
 - b. Enter the weight of the envelope.
 - c. Tap **Apply**.
6. Tap **Extra Services**.
7. Select any special services you wish to use.
8. Tap **Apply**.
9. Place the envelope or envelopes on the feed deck. Depending on the SendPro C model you have, feed the envelopes manually or tap **Start** to feed the envelopes.

Key in Postage

The Canada Post requires your postage to be calculated using a scale. This ensures that your mail always has the correct postage, and that you are not overpaying, or having mail returned for insufficient postage. Key in Postage is not available on any of the SendPro C devices.

7 - Address Management

In this section

Using the Address Book.....	81
Creating a shipping label from the Address Book.....	81
Creating a new sender address for shipping labels.....	81
Editing the sender address for shipping labels.....	82

Using the Address Book

The Address Book app allows you to add, edit, and delete addresses for everyone you ship to. Once you add an address to the Address Book app, you can select it when you print shipping labels.

To open the Address Book:

- Tap **SendPro Apps** on the Home screen, then tap **Address Book**.

Creating a shipping label from the Address Book

You can create a shipping label directly from an address you have selected in the Address Book.

1. Open the Address Book screen:
 - Tap **Address Book** at the bottom of the Home screen, or
 - Tap **SendPro Apps** on the Home screen, then tap **Address Book**.
2. Locate the address you wish to use for your shipping label.
3. Tap on the address to open it.
4. Tap **Print Trackable Label**.
5. Follow the steps for creating and printing a trackable label.

Creating a new sender address for shipping labels

If you need to ship from more than one address, you can add additional sender addresses to the Address Book.

1. Open the Address Book screen:
 - Tap **Address Book** at the bottom of the Home screen, or
 - Tap **SendPro Apps** on the Home screen, then tap **Address Book**.
2. Tap **Recipients** and select **Senders**.
3. Tap **+**.
4. Enter the sender information.
5. When complete, tap **Save**.

Editing the sender address for shipping labels

If you need to change a sender address, you can edit it in the address book.

1. Tap **SendPro Apps** on the Home screen, then tap **Address Book**.
2. Tap **Recipients** and select **Senders**.
3. Select the sender you wish to edit.
4. Tap **Edit**.
5. Make your changes and tap **Save**. The address book appears.

8 - Sealing

In this section

Filling the moistener tank	84
Sealing envelopes when you print postage	84
Sealing envelopes without printing postage	86
Avoiding envelope sealing issues	87

Filling the moistener tank

Your device will need refills of E-Z Seal® in order to seal envelopes. Follow these steps to fill the moistener tank.

1. Check the level of E-Z Seal® in your moistener tank **(1)**.

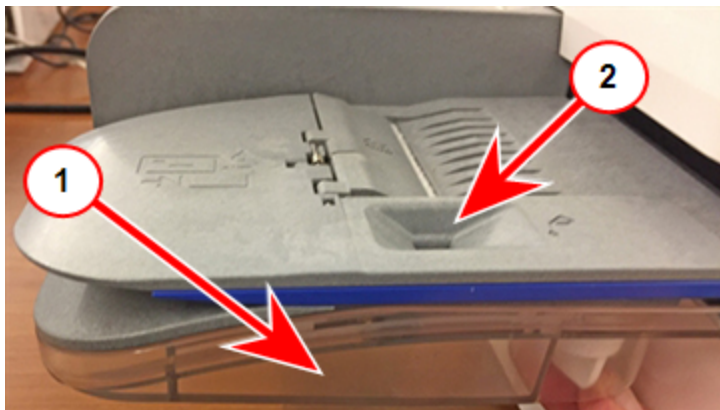

2. Add enough E-Z Seal® to bring the sealant level up to the bottom of the fill hole **(2)**. Do not overfill the tank.
3. If the tank is empty, allow 30 minutes for the moistener brush and wick to get completely wet.

Sealing envelopes when you print postage

You can seal envelopes and print postage at the same time with your SendPro C Lite, SendPro C, SendPro+.

Sealing

1. Check the level of sealing solution in the moistener tank. Add more if required.
2. Slide the envelope flap under the edge of the feed deck so the moistener can wet the flap.

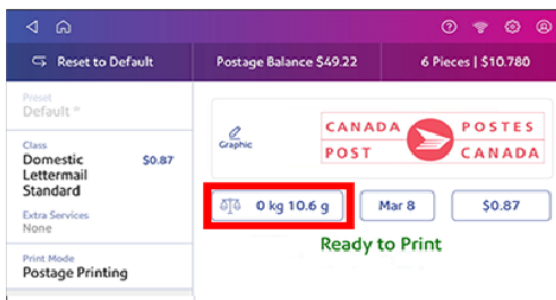

3. Tap **Print on Envelopes** on the Home screen.
4. Tap **Account** and select an account if accounting is enabled on your device.

5. Tap **Weight**.6. Tap **Scale**.

7. Place the envelope on the scale. You must do this before the next step or else **Apply** remains inactive.
8. Tap **Class** then select the class of mail you want.
9. Tap **Graphic** then select a graphic, if necessary.
10. Tap **Apply** to continue.
11. Insert the envelope into the device. The device prints the postage .

Important: If the moistener tank is full and your envelopes do not seal correctly, clean or replace the moistener brush and wick.

Sealing envelopes without printing postage

Use Seal Only mode to seal envelopes without printing anything.

1. Tap **Print on Envelopes** on the Home screen.
2. Tap **Print Mode**. You may need to swipe up on the screen to see this option.
3. Select **Seal Only**.
4. Tap **Apply**.

5. Place your envelope face up, flap down into the feeder. Be sure to slide the envelope flap under the edge of the feed deck.



6. Insert the envelope into the device. The device seals the envelope.



Avoiding envelope sealing issues

Prevent sealing issues by:

- Having enough sealant in the moistener tank.
- Placing the envelope correctly on the feed deck.
- Maintaining the wick or brush in the moistener.

1. Check the level of sealant in the moistener tank. Add more if required.

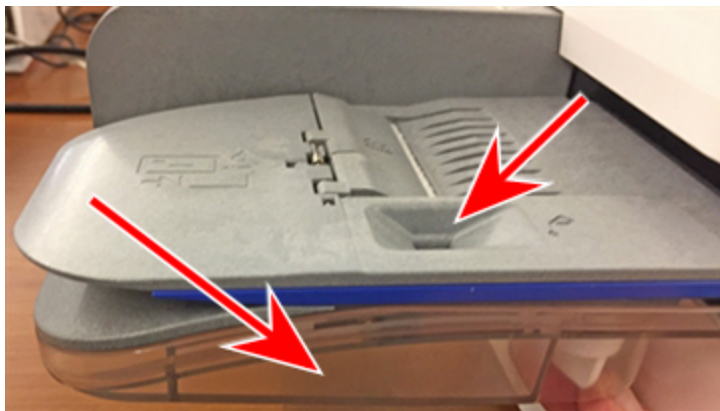

2. Slide the envelope flap under the edge of the feed deck when inserting an envelope. Otherwise, the moistener cannot wet the flap.

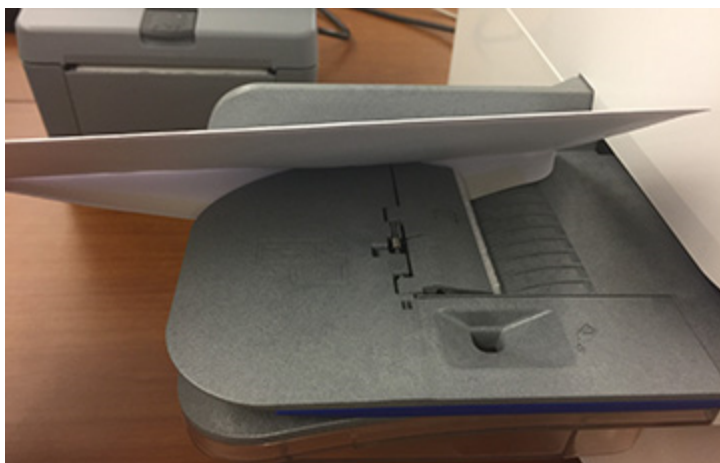

3. If the moistener tank is full, and your envelopes are still not sealing correctly, clean or replace your moistener brush and wick.

9 - History and Reports

In this section

Printing a funds report	90
Running account reports	90
Setting the report period for an account	91
Setting the account report preferences	92

Printing a funds report

Print a funds report if you need a report showing the total number of mailpieces sent.

The funds report provides the following information about your device:

- **Used:** The total amount used over the lifetime of the device.
- **Available:** The amount currently available to print.
- **Total Pieces:** The total number of mailpieces run over the lifetime of the device.
- **Control Sum:** The control sum is the total of the amount used and available.
- **Batch Count:** The current Batch Count.
- **Batch Value:** The current Batch Total.
- **PBP Serial No:** The serial number of the device.
- The date and time the report was printed.

To print a funds report:

1. Tap **Print on Envelopes** on the Home screen.
2. Tap the piece count in the upper right.
3. Tap **Print Report**.
4. Tap **SendPro C Envelope Printer**.
5. Place the envelope on the feed deck. Depending on the SendPro C model you have, feed the envelope manually or tap **Start** to feed the envelope.
6. Tap the **back arrow** to return to the Print on Envelopes app.

Running account reports

Run account reports to show how you spent your postage for a specific account or for all accounts over various time periods.

1. Tap **Print on Envelopes** on the Home screen.
2. Tap **Account**.
3. Tap **Preferences**.



4. Tap **Manage Accounts** on the home screen.
5. Tap **Reports**.

6. If this is the first time you are running a report:
 - a. Tap **Report Period** and set the time range for your reports.
 - b. Tap **Preferences** and set how you wish to identify the accounts.
7. Set the report period.
8. Tap **View & print reports**.
9. Tap to select a report.
10. Tap **Next**.
11. Choose what to do with the report:
 - To view the report on the screen, tap **View Report**.
 - Tap **Actions** to save the report under a new name, delete, print, or email the report. In order to print a report, you need an optional report printer.

Setting the report period for an account

Set the reporting period of an account report by setting its start and end dates.

1. Tap **Print on Envelopes** on the Home screen.
2. Tap **Account**.
3. Tap **Preferences**.



4. Tap **Manage Accounts**.
5. Tap **Reports**.
6. Tap **Report period**.

7. Select the calendar image next to the **Start date of fiscal year** field.

Report period defaults

Start date of fiscal year:
01.01.2023

End date of fiscal year:
31.12.2023

Default reporting period:
Calendar month

Calendar month periods for 2023:

Month 1	01.01.2023 to 31.01.2023
Month 2	01.02.2023 to 28.02.2023
Month 3	01.03.2023 to 31.03.2023
Month 4	01.04.2023 to 30.04.2023
Month 5	01.05.2023 to 31.05.2023

< Previous year Next year >

OK

- a. Select a date on the calendar.
 - b. Select **SET**.
- The End date of the fiscal year is set based on the start date you enter. You cannot enter this date manually.
8. Select the **Default reporting period** field.
 - a. Select a report period type.
 - b. Select **OK**.
 9. (Optional) Tap **Previous year** and **Next year** to view the reporting periods for the previous and next year. Tap **up** and **down** to scroll through the list of reporting periods for the current year.
 10. Tap **OK** to return to the Reports screen.

Setting the account report preferences

Set the account report preferences to select the account level you wish to report on (Account, Sub account or Sub sub account).

You can also choose how you want to identify accounts: by Name or by Code.

1. Tap **Print on Envelopes** on the Home screen.
2. Tap **Account**.
3. Tap **Preferences**.



4. Tap **Manage Accounts**.
5. Tap **Reports**.
6. Tap **Preferences**.
7. Tap to select how you want to identify accounts: by **Name** or by **Code**.
8. Select the account level you wish to report on: **Account**, **Sub account** or **Sub sub account**.
9. Tap **OK** to return to the Reports screen.

10 - Printing

In this section

Printing additional postage.....	95
Adding a graphic to your envelope in Print on Envelopes.....	95
Printing a graphic without printing postage.....	96
Printing only the date and time.....	96
Printing a test pattern.....	98

Printing additional postage

If you do not have enough postage on an envelope, you can add more postage directly on a blank area on your envelope or you can print the additional postage on a tape.

1. Tap **Print on Envelopes** on the Home screen.
2. Scroll down and tap **Class**.
3. Tap **Domestic Lettermail**.
4. Tap **Other Payments**.
5. Tap **Postage Correction**.
6. Tap the postage correction range you're applying: \$0.01-0.86 or \$5.96-650. Canada Post regulations stipulate that you cannot use postage correction values within the range of the Lettermail rating structure (\$0.87-5.95). If the amount required is within this range, use more than one stamp. For example, 2 stamps at \$0.49 to add \$0.98.
7. Use the keypad to enter the additional postage amount.
8. Tap **Apply**.
9. Verify the amount and tap **Apply**.
10. Feed a tape through the device.
11. Apply the tape beside or below the original impression as shown.
 - The tape must not overlap the original impression or cover any address information.
 - The word "Correction" appears on the tape.

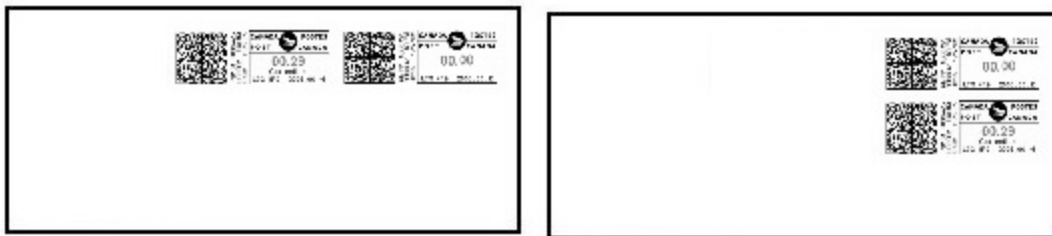

Adding a graphic to your envelope in Print on Envelopes

Your device comes with a set of standard graphic images that you can add to your envelopes or tapes when you print your postage. Graphic ads are also known as ads, slogans or logos. Examples include PLEASE OPEN IMMEDIATELY, RECYCLE, and Holiday Greetings.

Note: At this time, you cannot add your own custom graphics to your SendPro C Lite, SendPro C, SendPro+ device.

1. Weigh your envelope, select a class, and select any special services required.
2. Tap the **Graphic** icon on the Print on Envelopes screen.
3. Select the desired graphic.
4. Tap **Apply**.
5. To verify that the envelope prints correctly, feed the envelope through the device.

Printing a graphic without printing postage

Print a graphic without printing postage, such as the Received graphic on incoming mail.

1. Tap **Print on Envelopes** on the Home screen.
2. Tap **Print Mode**.
3. Select **Graphic Only**.
4. Tap **Apply**.
5. Tap **Graphic**.
6. Tap **Graphics**, then select your graphic.
7. Confirm with **Apply**.
8. Print the graphic on the envelope or tape.

Printing only the date and time

Print the date and time to keep a record of when you receive incoming mail.

1. Tap **Print on Envelopes** on the Home screen.
2. Tap **Print Mode** (you may have to scroll down to see this).

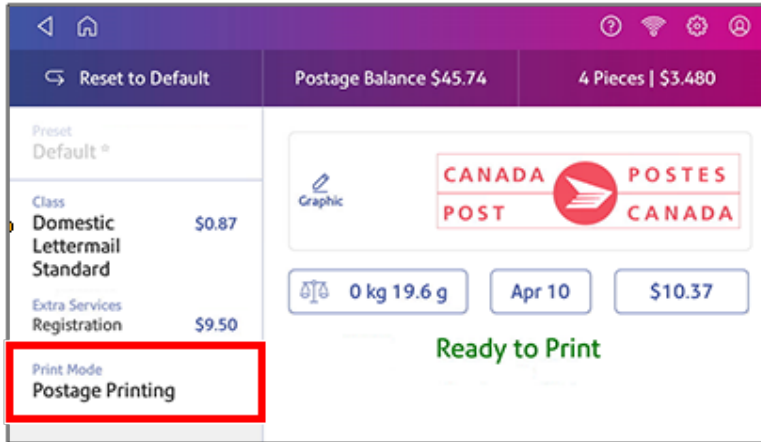

3. Select **Date and Time Stamp**.
4. Tap **Apply**.
5. Place the envelope or envelopes on the feed deck. Depending on the SendPro C model you have, feed the envelopes manually or tap **Start** to feed the envelopes.

Printing a test pattern

Print a test pattern to see if the printhead is working properly or if you have enough ink in the cartridge.

1. Tap **Settings**.



2. Scroll down and tap **Envelope Printer Maintenance**.
3. Tap **Print Test Pattern**.
4. Insert the envelope into the device when the message "Print a Test Pattern?" appears.
5. Examine the pattern printed on the envelope:
 - Tap **Done** if the lines are unbroken and match the "Good" test pattern shown on the display.
 - Tap **Clean Print Nozzle** if the test pattern has missing or incomplete lines
 - Once the cleaning operation completes, you must print another test pattern.
 - If this new pattern still has broken or missing lines, you may need to replace the ink cartridge or clean or replace the printhead.
 - If you see no improvement in print quality, do not repeat the cleaning, as cleaning the print nozzles consumes ink.

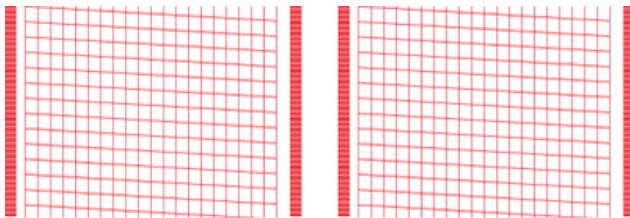

Good Test Pattern

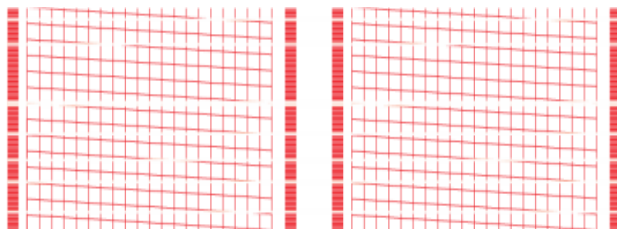

Bad Test Pattern

11 - Feeding and Jamming

In this section

Preventing envelope feeding problems..... 100

Preventing envelope feeding problems

Ensure you feed envelopes correctly to help prevent feeding problems.



Feeding mail

1. For your first envelope, hold the far edge of the envelope against the back wall of the feeder.
2. Slide the envelope into the feeder until you feel it touch the rollers. You hear the motor begin. Do not release the envelope until the feeder grabs it to pull it through the device.



3. You hear the motor continue to run for about 5 seconds once it prints postage on the envelope.
4. Continue to insert envelopes one at a time. Make sure you press the edge of each envelope against the back wall of the feeder and into the feeder until it touches the rollers.
 - Make sure the envelopes fully exit the feeder and do not pile up on the edge of the feeder.
 - If you are using a stacker, you may need to extend the stacker tray so that the envelopes exit the feeder completely.

Hold the envelope against the back wall to avoid skews

If you don't hold the envelope against the back wall it can skew. A skewed envelope can either exit the device with no postage applied or cause a jam. The message Clear Paper Jam appears. This could deduct funds. Even a minor skew that may be difficult to see can cause a jam.

Cleaning the feeder

Using a can of non-flammable compressed air, blow on the feed deck on the left side and work toward the transport deck on the right side of the device. Make sure to remove all the dust and debris.

12 - Ink

In this section

Ordering ink cartridges.....	103
------------------------------	-----

Ordering ink cartridges

Use postal approved ink cartridges. Non-postal approved ink cartridges can damage your device.

When your device shows the low ink warning, you will receive an ink cartridge automatically if you use the AutoInk program. You can enable AutoInk through My Account on the Pitney Bowes website.

13 - Settings

In this section

Creating or disabling the security PIN.....	105
Adjusting time zone and scale location code.....	106
Advancing the date.....	106
Re-dating your mail.....	107
Adjusting display brightness.....	107
Comparing rates for classes and services for Print on Envelopes.....	108
Uploading postage transactions.....	109
Clearing or resetting the number of mailpieces sent ...	109
Performing Canada Post postal inspections for postage printing.....	110
Uploading system logs.....	110

Creating or disabling the security PIN

Create a security PIN to prevent unauthorised use of your device.

If you created a security PIN when you installed your device, you must enter it when you turn your device on or after it enters sleep mode.

Create a security pin

1. Tap **Settings**.



2. Tap **Security PIN** in the Device & Network section.
3. Tap **Create PIN**.
4. Enter a 4-digit numeric PIN using the keyboard on the display.
5. Verify your PIN by entering it again.

Change or disable the security PIN

1. Tap **Settings**.



2. Tap **Security PIN** in the Device & Network section.
3. Tap **Change PIN** or **Turn OFF Security PIN**.
4. Enter the current security PIN for either option.

Manually lock your device

1. Tap the user profile image.

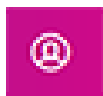

2. Tap **Lock this device**. The screen saver displays shortly after the Device is Locked screen appears.

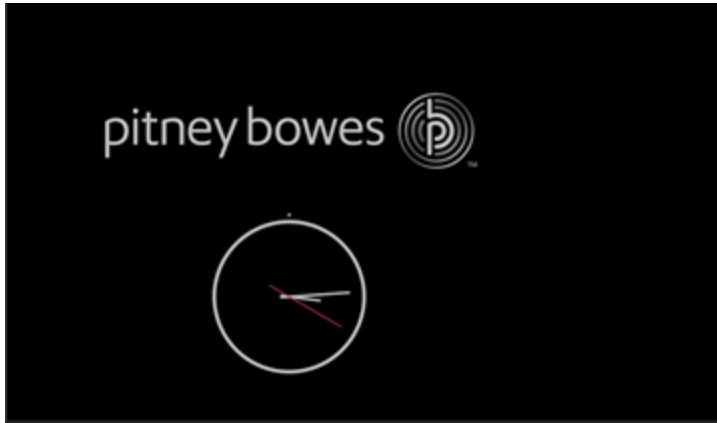

If you forget your Security PIN, tap on the **Forgot PIN?** link to get help.

Adjusting time zone and scale location code

When you move your device to a new location or install a new scale, you must modify the location code and time zone value.

1. Tap **Settings**.



2. Tap **Location & Time Zone**.
3. Enter the new location code.
4. Enter the time zone.
5. Tap **Apply**.

Advancing the date

Advance the date to print postage up to thirty days before you need to send it.

1. Tap **Print on Envelopes** on the Home screen.
2. Tap the date. The calendar appears.

3. Tap **Tomorrow** or **Another Date**, depending on the date you wish to print.
4. When you see the future date highlighted on the calendar, tap **Apply**.
5. Place the envelope or envelopes on the feed deck. Depending on the SendPro C model you have, feed the envelopes manually or tap **Start** to feed the envelopes.

Important: The date on the postage should match the date when your mail goes to the post office. Your device automatically advances the printed date on the device stamp (as well as its internally held date) when the device time reaches 5:00 PM. You cannot change this time.

Re-dating your mail

If you already printed today's date and postage on an envelope, but you missed your mail pickup, you can re-date the mail. You must print a future date on the back of the envelope before you can mail it.

1. Tap **Print on Envelopes** on the Home screen.
2. Scroll down and tap **Class**.
3. Tap **Domestic Lettermail**.
4. Tap **Other Payments**.
5. Tap **Date Correction**.
6. Tap **Apply**.
7. Tap on the date.
8. Tap **Tomorrow** or **Another Date**, depending on the date you need.
9. Tap **Apply** after you select the new date.
10. Print a tape and attach it to the front of the envelope next to or below the original postage.
 - The tape must not overlap the original print or cover any address information.
 - The tape will show the corrected date and \$0.00 postage.

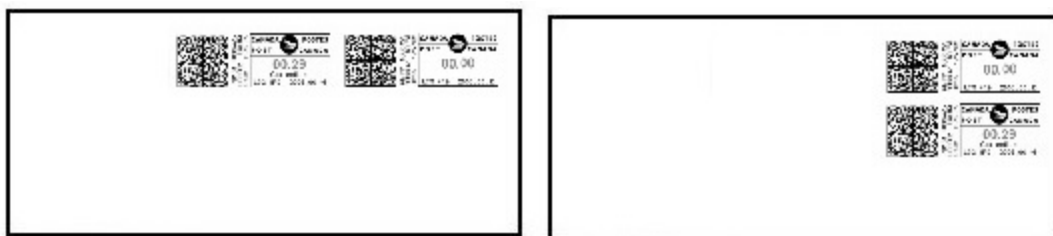

Adjusting display brightness

Set the brightness of the display to suit your work space.

1. Tap **Settings**.



2. Tap **Display Brightness** in the Device & Network section of the screen.
3. Move the slider to adjust the brightness.
4. Tap the **back arrow** or **Home** to exit the Settings screen.

Comparing rates for classes and services for Print on Envelopes

You can compare postage rates for various classes and services when printing postage using the Print on Envelopes application.

Tap **Class** on the Envelope Printing screen. You can then select and compare the costs of different classes and services. The total cost for each class and services combination appears.

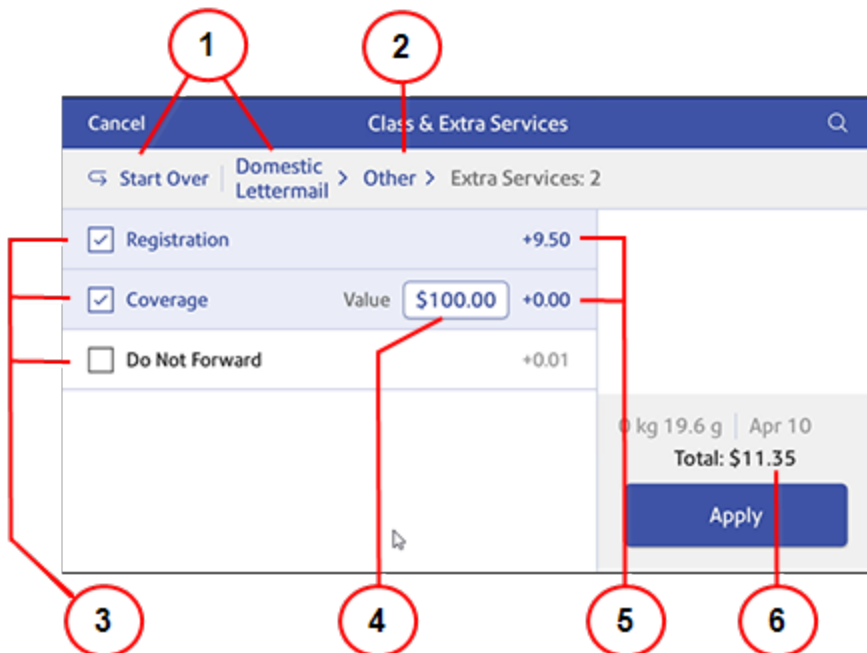

1. Tap to change class.
2. Tap to change package type.

3. Extra services available for class you selected
4. Value
5. Rates for extra services
6. Total postage amount

Uploading postage transactions

Automatic upload of your postage transactions

- Your device automatically uploads your postage transactions to the Pitney Bowes Data Center. This occurs at least once during the day and once after hours.
- If you lock your device or turn it off for any extended period, it automatically uploads your transactions when you turn it on again.
- If you see the message , it means you need to upload your transactions.

Important: If your device had connection issues recently, it may require multiple uploads to upload transactions. If the device prompts you to upload more than three times, please contact technical support.

Manual upload of your postage transactions

1. Tap **Settings**.



2. Scroll down to the Envelope Printer Settings section.
3. Tap **Sync Transaction Data**.
 - A series of messages appear, starting with "Preparing Transaction Data" followed by "Sending Transaction Data."
 - Once the upload is complete, the message "Transaction Data Sent" appears.
 - The message "No Sync Required" appears if there are no new transactions to upload.

Clearing or resetting the number of mailpieces sent

Reset the piece counter to delete the piece count information.

Make certain that you wish to delete the piece count information. Once you do so, you cannot restore the deleted data.

1. Tap **Print on Envelopes** on the Home screen.
2. Tap **Pieces**.
3. Tap **Reset Counter to 0**.

Performing Canada Post postal inspections for postage printing

Perform a balance inquiry or postage refill when the Inspection Due message appears.

When a postal inspection is required, you are notified automatically by the "Inspection Due. Perform a balance inquiry or a refill" message on the Print on Envelopes app.

1. If accounting is enabled, you must first tap **Account** and select an account.
2. Tap **Balance Inquiry** or **Refill Postage** to complete the inspection.

Uploading system logs

Your device creates system logs that monitor operations on your device. If you need to upload system logs to a Pitney Bowes support representative, you can find them in the Advanced Device Options section under Settings.

1. Tap **Settings**.



2. Scroll down to the Advanced device Options section.
3. Tap **System Log Upload**.
4. Select the logs you want to upload.

5. Tap **Upload Selected Logs**.



6. Once the upload completes, an upload message bar appears at the bottom of the screen.
7. Tap **OK** or **Got It** in the message bar. The device returns to the Home screen.

14 - Rate Change

In this section

Updating postal rates or software for Print on Envelopes.....	113
--	-----

Updating postal rates or software for Print on Envelopes

Automatic updates

SendPro C Lite, SendPro C, SendPro+ devices update postal rates and software automatically.

Keep your device turned on and connected to your network to get any updates, as the device downloads updates during the evening hours.

Manual updates

Perform manual updates only if your automatic update fails to complete.

Manual postal rate updates

1. Tap **Rates and Updates** on the bottom of the Home screen. Swipe the screen up to access the second row of buttons.

Important: Rates downloaded prior to the effective date receives the below message for 3 days after the download and the message will show for 3 days after the effective date. You cannot remove the message.

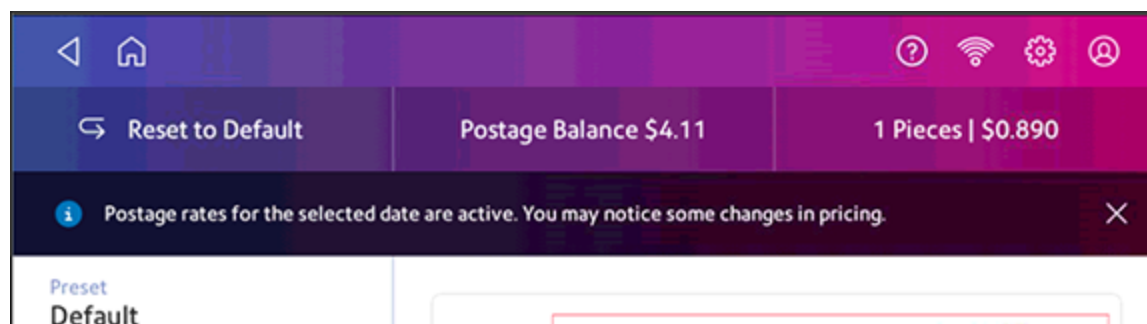

Manual software updates

1. Tap **Rates and Updates** on the bottom of the Home screen.
2. Once the download and install process completes, you see the message "Finalizing Update".

Visit our [Rates and Software Updates](#) page for more information.

15 - Maintenance

In this section

Installing the printhead.....	115
Cleaning the printhead.....	120
Cleaning the moistener brush and wick assembly.....	125
Supplies, ink cartridges, and options.....	130

Installing the printhead

You may need to install a new printhead when the existing printhead is producing poor print quality.

1. Tap **Settings**.



2. Scroll down and tap **Envelope Printer Maintenance**.
3. Tap **Install Printhead**.
4. Lift the cover. The ink cartridge moves to the front position.
5. Flip the ink cartridge cover open.

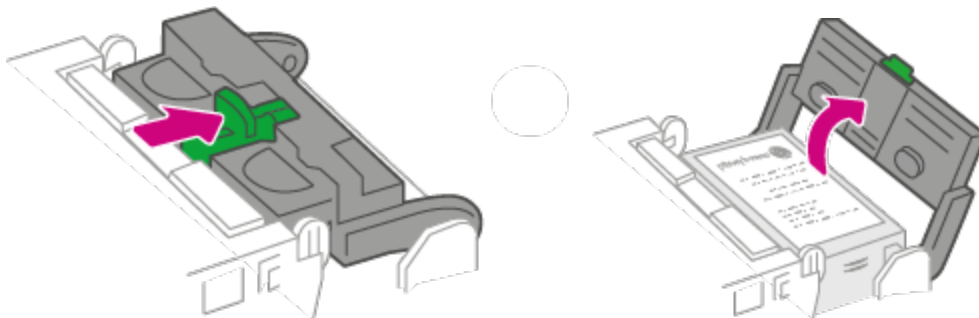

6. Remove the ink cartridge.

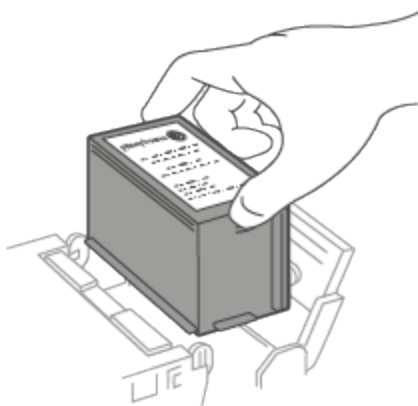

7. Squeeze the two gray tabs on either side of the printhead.

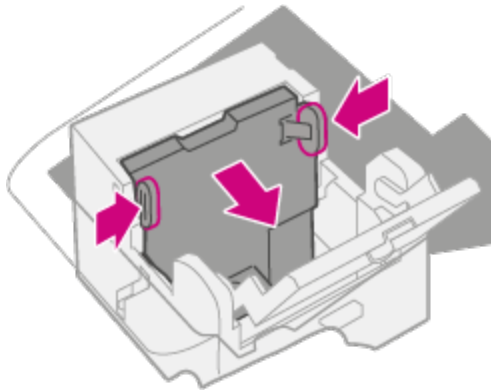

8. While squeezing, lift and tilt the printhead to the right. The printhead should come up out of the device.

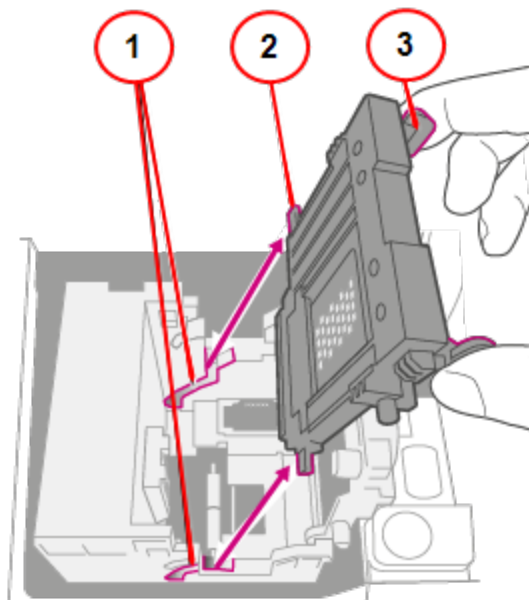

1. Grooves.
2. Peg.
3. Tab.

9. Unwrap the new printhead and remove the protective strip.

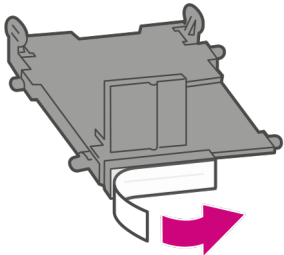
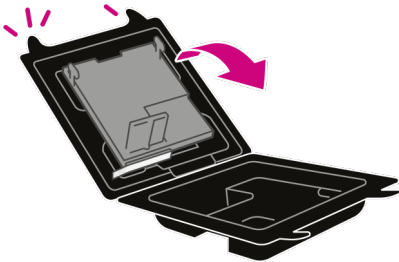

10. Squeeze the tabs and slide the printhead pegs into the lower set of grooves.

Warning: If you do not seat the printhead correctly it can damage the device.

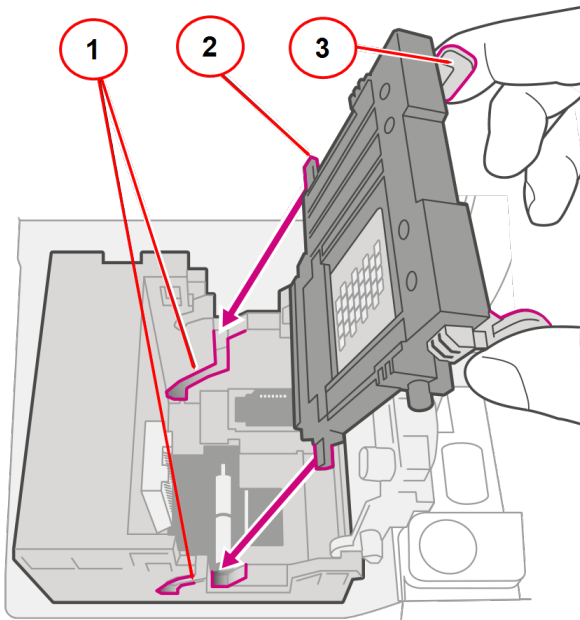

1. Grooves.
2. Peg.
3. Tab.

11. Keep squeezing the tabs and push the printhead flush against the wall. Tabs will snap outward when placed correctly.

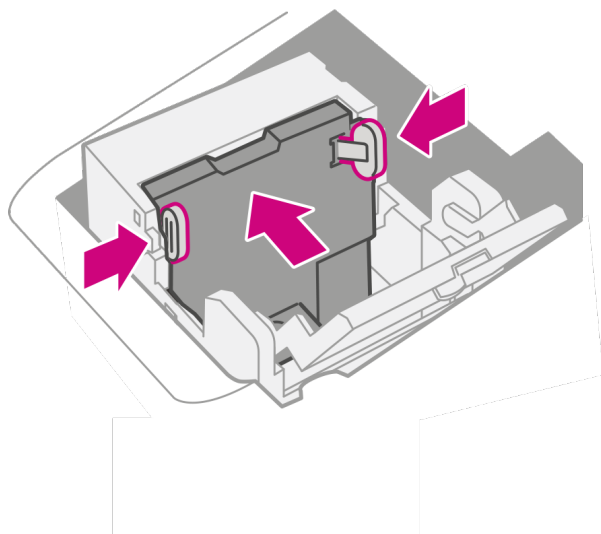

12. Install the ink cartridge and close the guard.

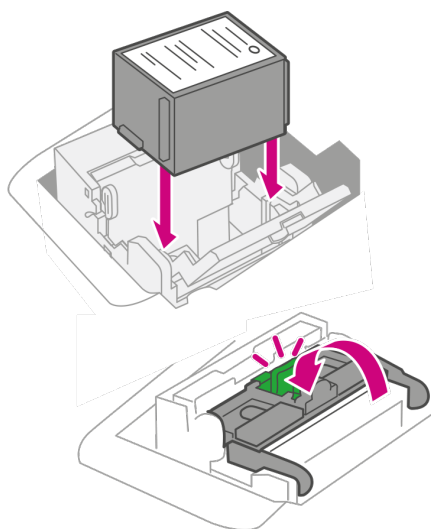

13. Close the cover. The ink cartridge moves back to the original position.

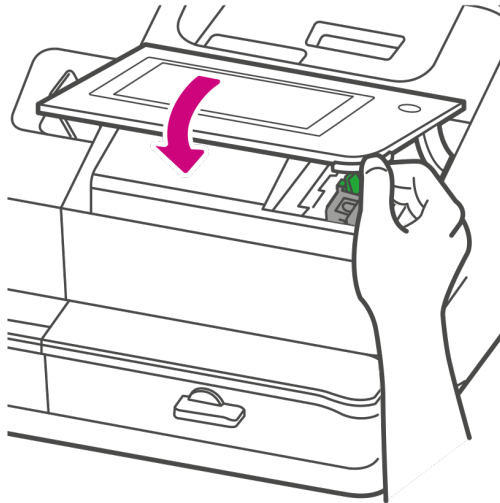

14. Tap **Done**.
15. Print a print test pattern to be sure that your printhead is working properly.

Cleaning the printhead

If you clean the print nozzle and you still get a bad test print pattern, try cleaning the printhead.

1. Tap **Settings**.



2. Scroll down and tap **Envelope Printer Maintenance**.
3. Tap **Install Printhead**.
4. Lift the cover. The ink cartridge moves to the front position.

5. Flip the ink cartridge cover open.

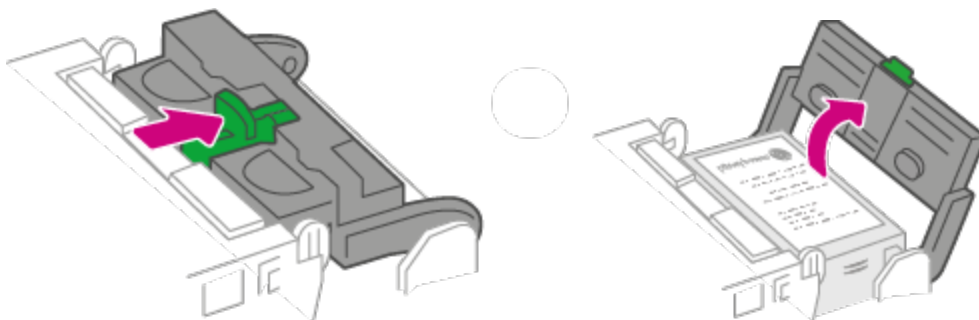

6. Remove the ink cartridge.

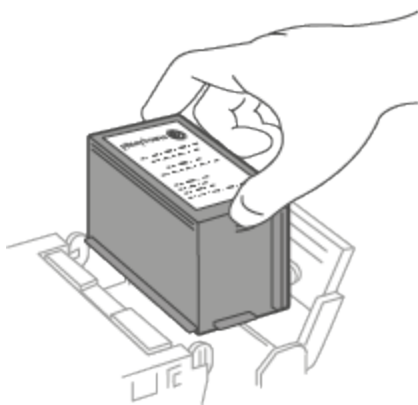

7. Squeeze the tabs on either side of the printhead.

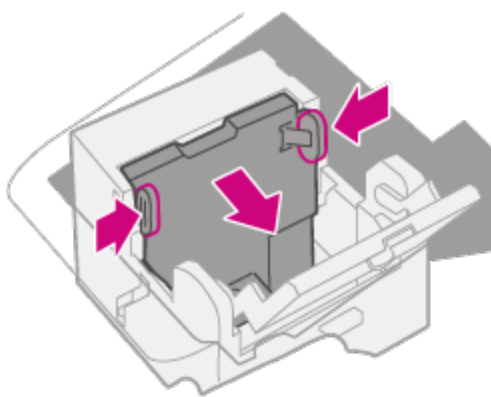

8. While squeezing, lift and tilt to the printhead to the right. The printhead should come up out of the device.

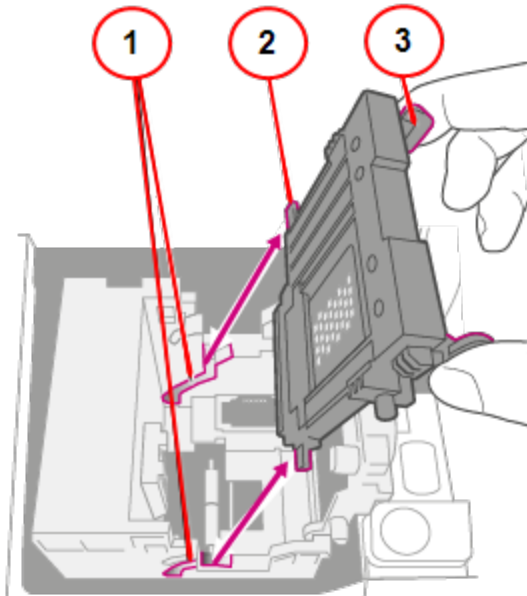

1. Grooves.
2. Peg.
3. Tab.

9. Clean off the printhead by wiping the surface of the printhead with a dry, lint-free cloth or a foam swab.

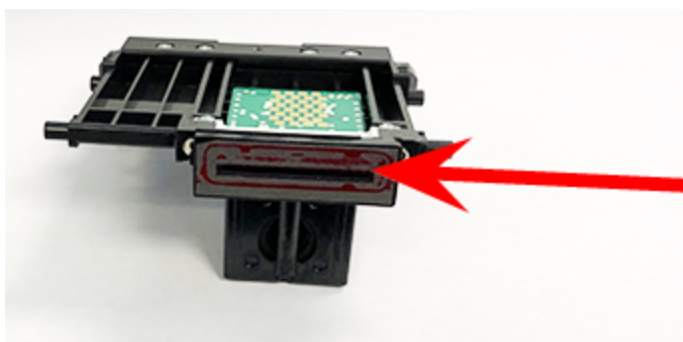

10. Squeeze the tabs and slide the printhead pegs into the lower set of grooves.

Warning: If you do not seat the printhead correctly it can damage the device.

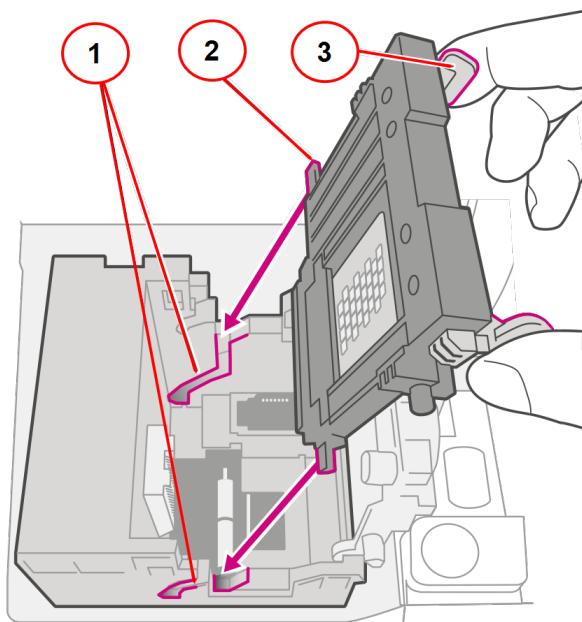

1. Grooves.
2. Peg.
3. Tab.

11. Keep squeezing the tabs and push the printhead flush against the wall. The tabs snap outward when placed correctly.

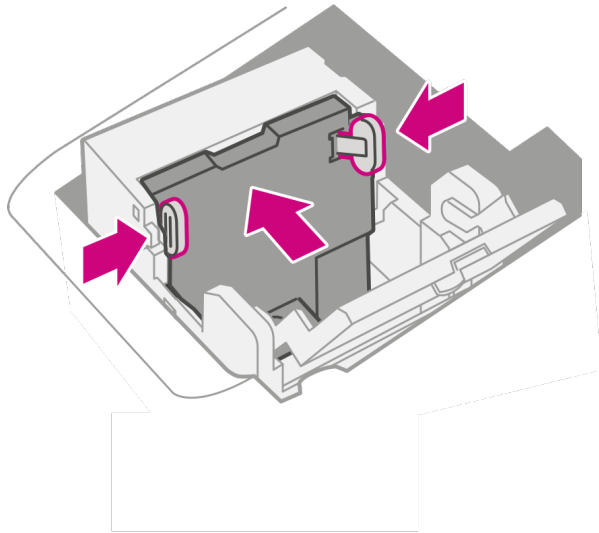

12. Install the ink cartridge and close the guard.

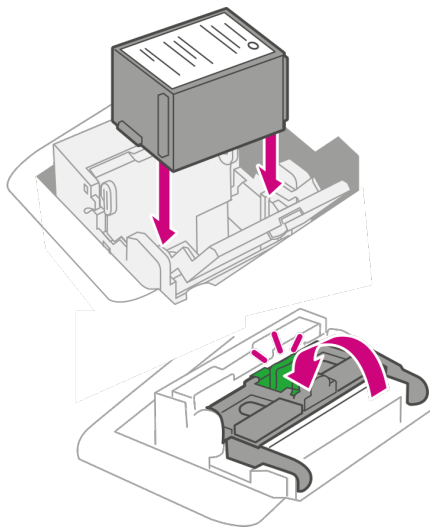

13. Close the cover. The ink cartridge moves back to the original position.

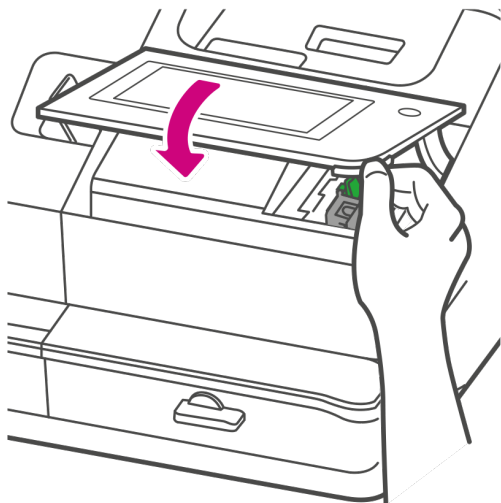

14. Tap **Done**.
15. Print a print test pattern to be sure that your printhead is functioning properly.
16. If the test pattern looks good, tap **Done**.

Cleaning the moistener brush and wick assembly

Clean the moistener brush and wick if the moistener tank is full and your envelopes are not sealing properly.

1. Unscrew the plastic thumbscrew under the moistener base.

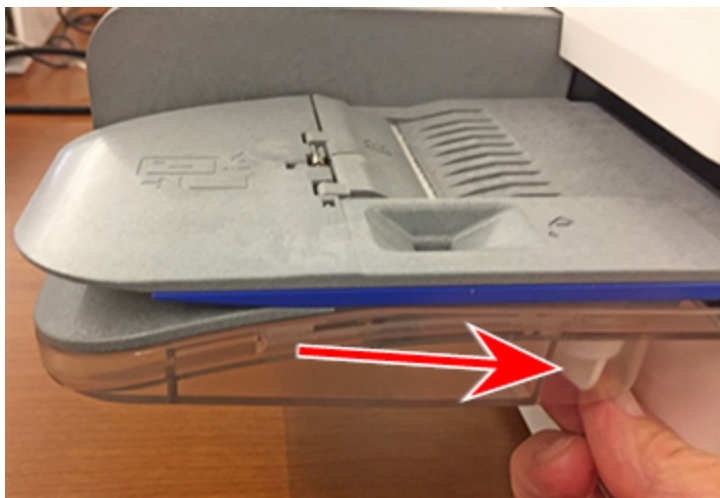

2. Lift the moistener brush assembly off the top of the moistener base.



3. Turn the assembly over and slide the moistener brush out of the holder.

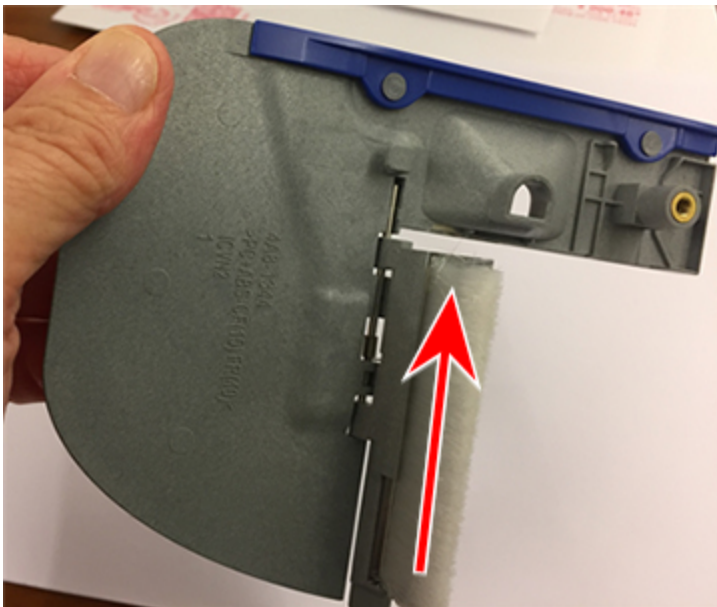

4. Locate the wick on the moistener base.

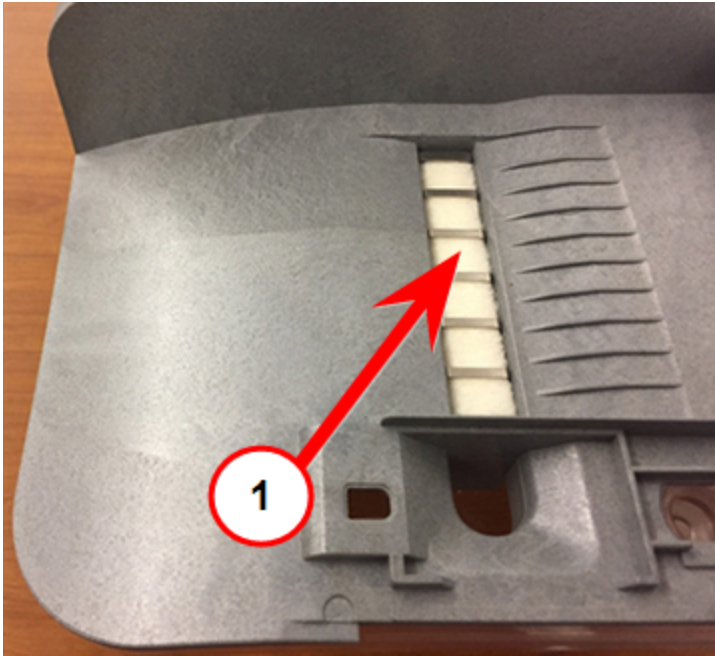

1. Wick.

5. Remove the metal grate and wick from the moistener base.



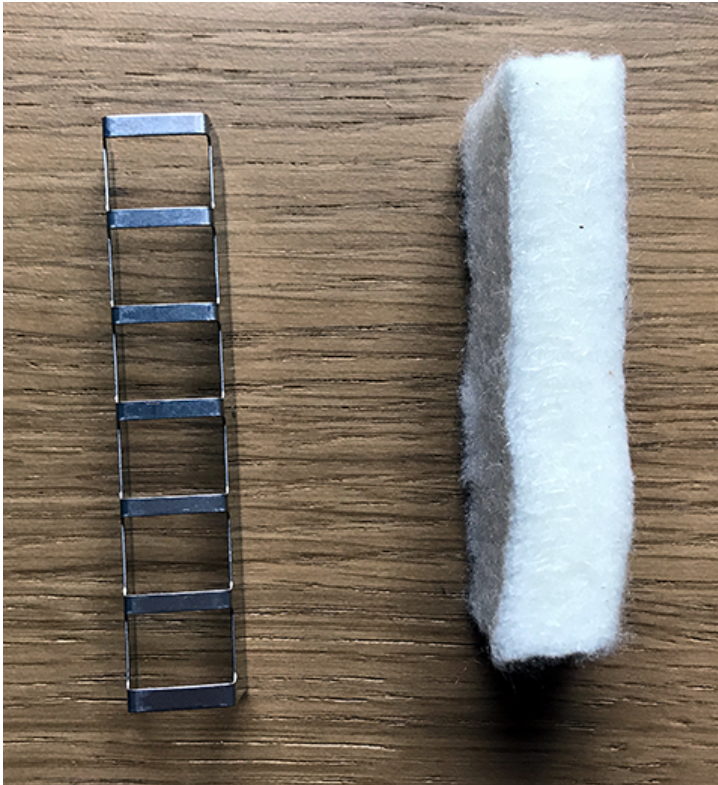

6. Clean the brush and wick with water and rinse thoroughly.
7. Place the wick back in the metal grate and replace the grate in the moistener base.
8. Slide the moistener brush back into the holder.
9. Replace the moistener brush assembly on top of the moistener base and secure with the plastic thumbscrew.
10. If your envelopes still are not sealing properly, please chat with us to order a Moistener Replacement Kit.

Supplies, ink cartridges, and options

Visit our [supplies website](#) to order supplies for your device.

16 - Product Information

In this section

Printing postage on envelopes.....	132
Moving the SendPro C Lite, SendPro C, SendPro+....	133
Canada Post requirements.....	133
Sections of the meter impression.....	134
Postal Security Device.....	134
Parts of the SendPro C Lite, SendPro C, SendPro+....	134
Connections on the back.....	135
Specifications.....	136
Material specifications.....	139
Contacting Pitney Bowes.....	142
Third party software.....	143

Printing postage on envelopes

The Print on Envelopes app is the starting point for printing postage on an envelope or a tape. It also allows you to change what you print.

To open the Print on Envelopes screen, tap **Print on Envelopes** on the Home screen.

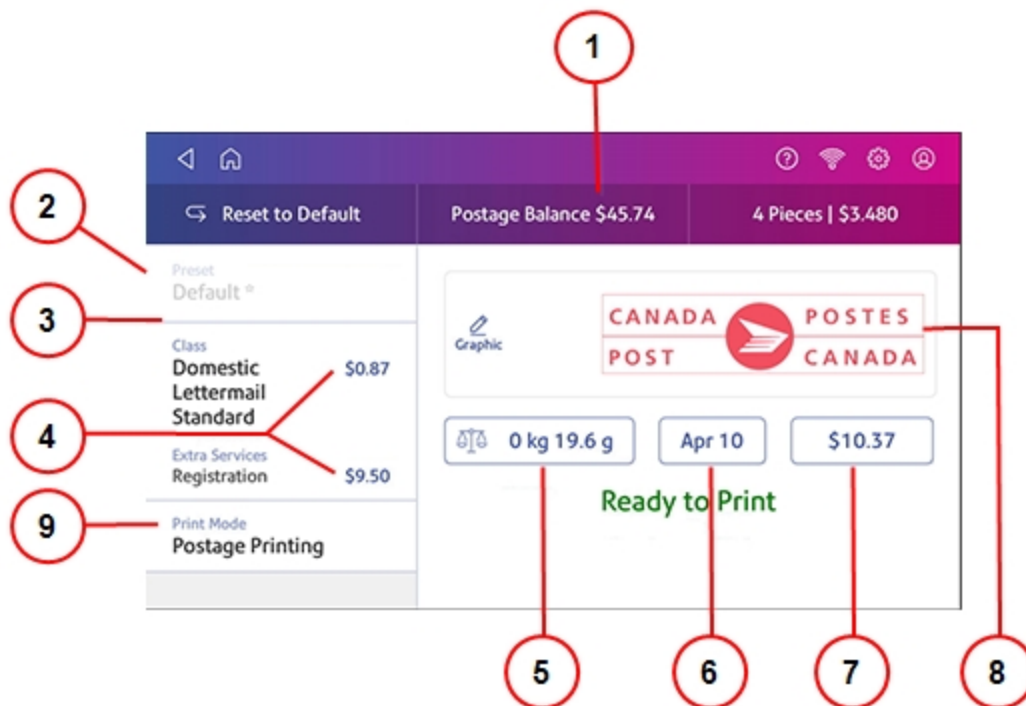

On this screen, you can:

1. View the balance of funds you have remaining in your device.
2. Select a Preset for your letter.
3. Select an account by tapping **Account** (this option appears if your device has the account feature enabled).
4. Tap **Class** to view the class and any extra services.
5. Tap the weight icon to view the weighing options (enter weight manually or using a scale).
6. Tap the date to view the date options.
7. View the total postage amount.
8. Preview or add graphics.

9. Tap **Print Mode** to access the Print mode screen. This provides you with different printing modes such as adding graphics to your envelope, adding more postage, or making corrections to the date. You can also choose to only seal envelopes without printing any postage.

Moving the SendPro C Lite, SendPro C, SendPro+

Move your device safely, whether you are moving it across the room or to a new facility.

1. If you have a scale, remove it from the device.
2. Remove the moistener assembly. Once you have removed and cleaned the assembly, place it in a zip-top bag to prevent any remaining fluid from leaking.
3. Remove the ink cartridge. Once you get the ink cartridge out, place it in a zip-top bag.
4. Close the top cover.
5. Remove all USB cables and optional peripherals such as printers or scanners. Pack them with the device.
6. Unplug the power cord and pack it with the device.
7. Once in the new location, re-install all USB cables and peripherals.
8. Plug the power cord into the device and power outlet.
9. Re-install the ink cartridge.
10. Re-install the moistener assembly.

Canada Post requirements

Your device (Postal Security Device) has a license with the Canada Post. Therefore, you must follow a few basic requirements.

- Mail must have the correct date and postage amount shown.
- Metered mail must show the Postal code location of the post office where the postage device is registered.
- If you move to another Postal code location, you must update the Postal code.
- The Canada Post requires a postal inspection of your machine every 90 days. Each time you refill your postage device through the network, thePB Postage device Payment System computer automatically performs a postal inspection. The postage tape you use must meet specifications.

Sections of the meter impression

The meter impression contains elements that identify the mailer and the type of mail.



1. Datamatrix barcode - contains tracking information
2. Meter serial number
3. Postage amount
4. Date
5. Postal Code of the machine
6. Optional advertisement

Postal Security Device

The postage meter on your mailing system is a Postal Security Device (PSD) that secures your postage funds. It includes the latest technology approved by Canada Post. This technology eliminates the need for Canada Post to perform physical inspections, thereby making your device easier and more convenient for you to use.

Parts of the SendPro C Lite, SendPro C, SendPro+

Familiarize yourself with the parts of your SendPro C Lite, SendPro C, SendPro+.



1. **Integrated scale** - Weigh envelopes and packages.
2. **Color touchscreen display** - Provides access to the apps available on your device.
3. **Ink access cover** - Allows access to the ink cartridge. Find the model and serial numbers inside.
4. **Envelope stacker** - Mail collects here after the printing process.
5. **Paper jam lever** - If a stall occurs on the transport deck, turn this to clear the envelope, post card or tape strip.
6. **Envelope moistener** - Moistens the flap of the envelope.
7. **Semi-automatic feeder** - Feeds and seals envelopes. Also feeds postcards and tape strips.
8. **Optional thermal label printer** - Prints shipping labels without using ink.

Connections on the back

Familiarize yourself with the ports on the back of your device.

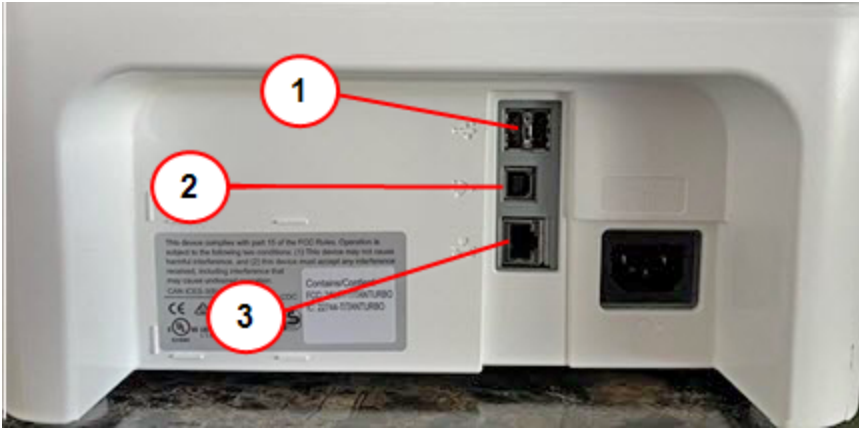

1. **USB port type A host** - Connect a Barcode scanner, external printer or external scale to these ports.
2. **USB port, type B host** - Service personnel use only.
3. **RJ45** - Use for a wired network connection.

Specifications

Review the specifications of your SendPro C Lite, SendPro C, SendPro+ including the throughput, ink cartridge yield and other component details.

Power requirements

100-240 VAC, 50/60 Hz, 1.0 A

Operating Temperature

13°C to 35°C

Sound Level

Less than or equal to 70 dBA re 20 micro Pascal in accordance with ISO 7779, ISO 3744, or ISO 3741.

Dimensions



1. Length 419 mm
2. Width 394 mm
3. Height 286 mm

Weight

8 kg

Throughput (Letters Per Minute)

- Up to 65 letters per minute
Actual throughput varies, depending on the material used, device condition, use of moistener, etc.

Ink Cartridge Life

- 17 ml cartridge - yields up to 1,500 impressions. (Actual ink yields vary with usage and environmental conditions).
- 35 ml cartridge - yields up to 3,000 impressions. (Actual ink yields vary with usage and environmental conditions).

Please also see [Ordering ink cartridges on page 103](#).

Ports

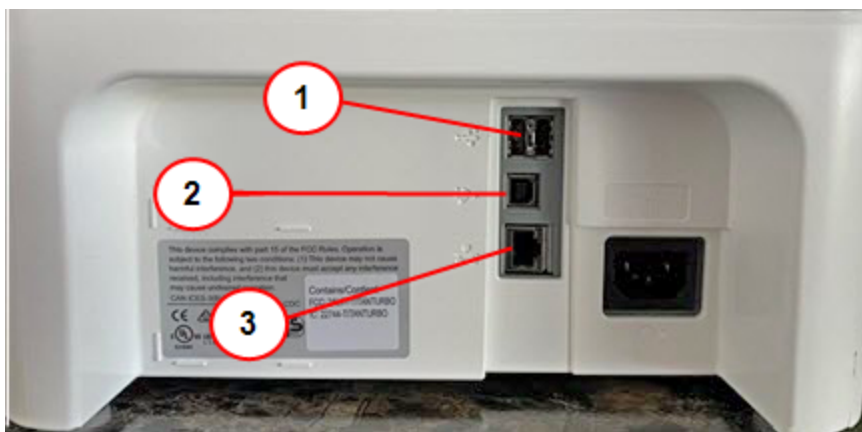

1. **USB port type A host** - Connect a Barcode scanner, external printer or external scale to these ports.
2. **USB port, type B host** - Service personnel use only.
3. **RJ45** - Use for a wired network connection.

Display

7-inch tablet (169 pixels/inch)

Print Resolution

300 H x 600 V dpi

Print Image Area

25.4 mm x 180 mm

Tapes and Strips

Self-adhesive, dual tape strip for use on mailpieces that are too large to run in the device. Ideal for adding postage to oversized envelopes, priority mail and packages.

Postal Inscriptions

Up to 60 inscriptions preloaded on the device.

Graphics

Up to 60 graphic ads on the device.

Connectivity Options

- Wired Ethernet connection.
- Wireless connectivity.
- SendPro Cellular connectivity device.

Material specifications

Review the material specifications including the minimum and maximum envelope sizes, envelope stack height, and tape size details.

Envelope dimensions

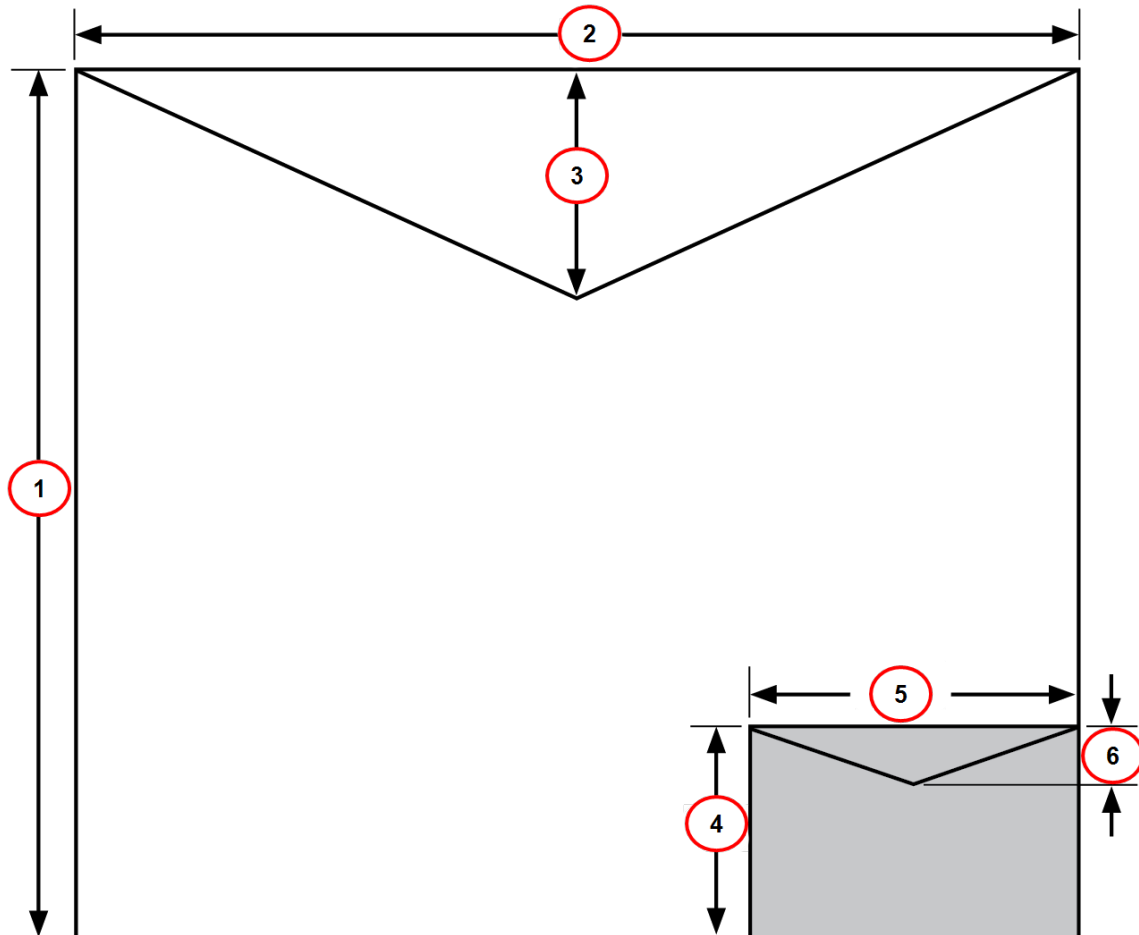

1. Maximum height: 330 mm.
2. Maximum width: 381 mm.
3. Envelope flap depth, maximum: 76 mm
4. Minimum height: 89 mm
5. Minimum width: 127 mm
6. Envelope flap depth, minimum: 22 mm

Envelope Thickness

- Minimum: 0.20 mm
- Maximum: 9.5 mm

Stack Height for Mail

- 76.2 mm – This is the height of the inner edge of the side guide

Envelope Weight

- Minimum: 1 g
- Maximum: 450 g

Tape Size

- Minimum: 44.2 x 100 mm
- Maximum: 44.7 x 200 mm

For a proper seal, the envelope's minimum flap angle must meet the following criteria:

- For envelopes with a flap length from 25-60 mm, the minimum flap angle is 18 degrees.
- For envelopes with a flap length greater than 60 mm to the maximum flap length for the particular model, the minimum flap angle is 21 degrees.

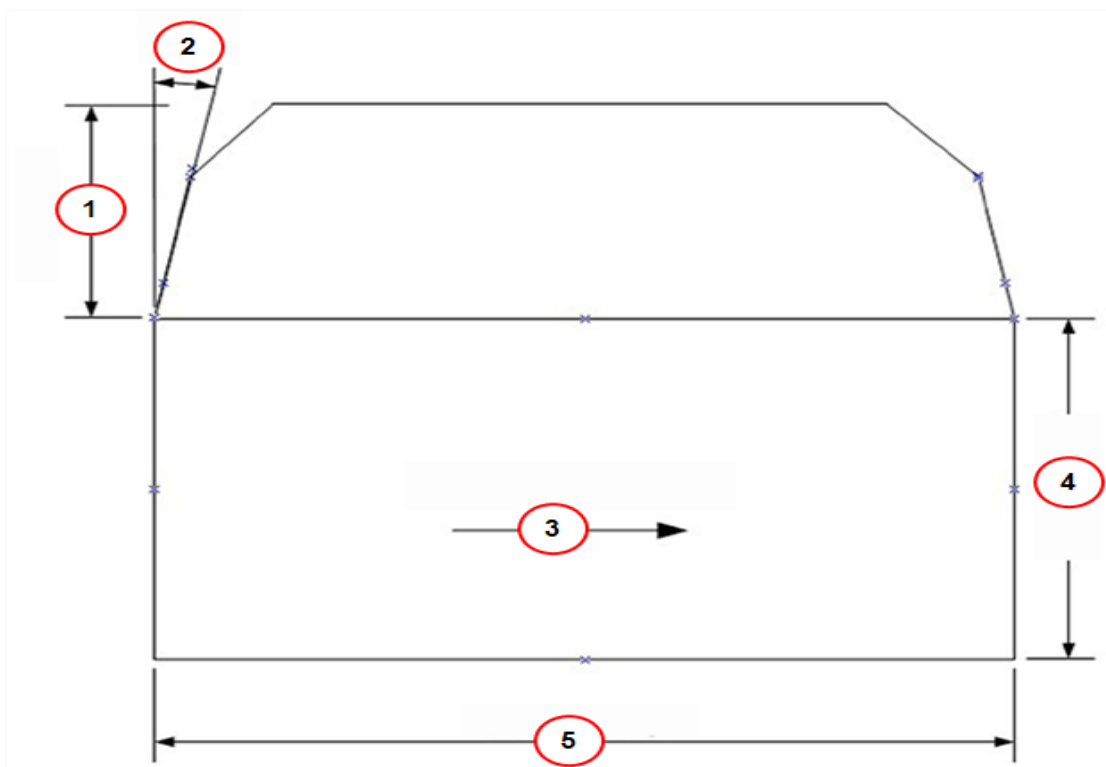

1. Flap length.
2. Minimum flap angle.
3. Mail processing direction.
4. Mailpiece length.
5. Mailpiece width.

Contacting Pitney Bowes

Before contacting Pitney Bowes Technical Support:

In order to find the correct information for your device, you need to know the model number.

To locate the **(1) Product Code Number (PCN)** and the **(2) 7-digit serial number**, check the label on the rear of the device or under the display cover as shown here. Note that the serial number appears blurred here for security reasons.

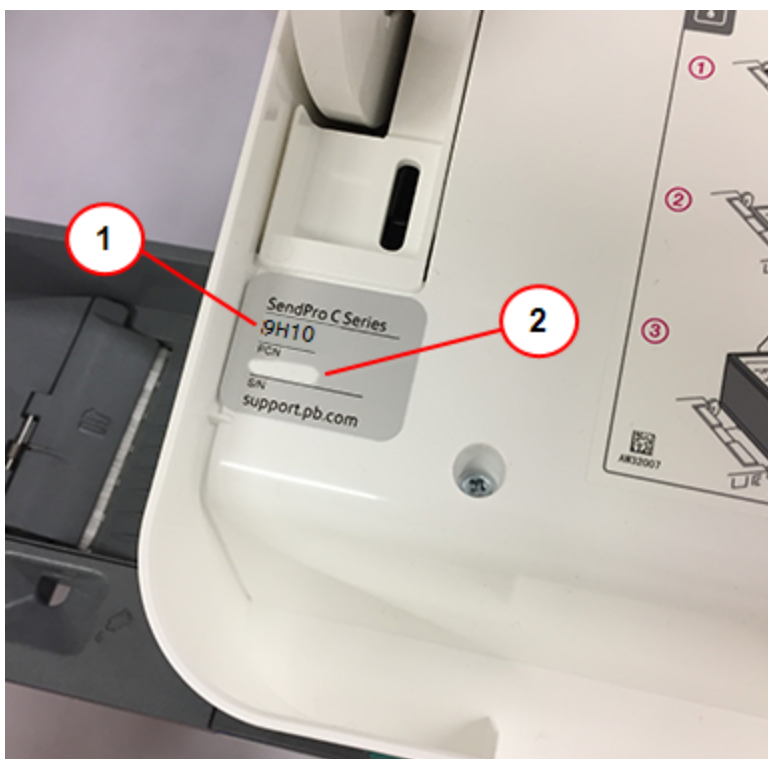

Be sure to have the following information available before contacting Pitney Bowes Technical Support:

- **Product Name:** SendPro C Lite, SendPro C, SendPro+ device
- **PCN and serial number:** check the label under the front cover of the machine.

Provide a description of the problem

- What is happening and when?
- Are there any error messages?

Describe your attempts to fix the problem

- What steps have you already tried to fix the problem?
- If you tried, what happened?

Contact Technical and Account Support:

Visit our website at (copy the URL and paste it into a browser):

<http://pitneybowes.com/ca/en/sendproc-support>

For the Pitney Bowes Supplies

Web support: Visit our website at (copy the URL and paste it into a browser):

<http://pitneybowes.com/ca/en/sendproc-support>

Click on **Shop** at the top of the page.

Third party software

Third party software may have been incorporated into this product by Pitney Bowes Inc. (“PBI”) under permission from PBI’s licensors. Any special terms and conditions that apply to such software are provided below:

This product contains the following software:

- Okhttp3 which is licensed under the Apache License, Version number 2.0. The license can be downloaded from: <http://www.apache.org/licenses/LICENSE-2.0.html>. The source code for this software is available from <http://square.github.io/okhttp/>.
- Retrofit which is licensed under the Apache License, Version number 2.0. The license can be downloaded from: <http://www.apache.org/licenses/LICENSE-2.0.html>. The source code for this software is available from <https://square.github.io/retrofit/>.

- Okio which is licensed under the Apache License, Version number 2.0. The license can be downloaded from: <https://github.com/square/okio/blob/master/LICENSE.txt>. The source code for this software is available from <https://github.com/square/okio>.
- Commons-codec which is licensed under the Apache License, Version number 2.0. The license can be downloaded from: <http://www.apache.org/licenses/LICENSE-2.0.html>. The source code for this software is available from https://commons.apache.org/proper/commons-codec/download_codec.cgi.
- Commons-io which is licensed under the Apache License, Version number 2.0. The license can be downloaded from: <http://www.apache.org/licenses/LICENSE-2.0.html>. The source code for this software is available from https://commons.apache.org/proper/commons-io/download_io.cgi.
- Org.greenrobot:eventbus which is licensed under the Apache License, Version number 2.0. The license can be downloaded from: <http://www.apache.org/licenses/LICENSE-2.0.html>. The source code for this software is available from <http://greenrobot.org>.
- Org.greenrobot:greendao which is licensed under the Apache License, Version number 2.0. The license can be downloaded from: <http://www.apache.org/licenses/LICENSE-2.0.html>. The source code for this software is available from <http://greenrobot.org/greendao>.
- FasterXml:jackson.core:jackson-core which is licensed under the Apache License, Version number 2.0. The license can be downloaded from: <http://wiki.fasterxml.com/JacksonLicensing>. The source code for this software is available from <http://wiki.fasterxml.com>.
- Aws-android-sdk-core which is licensed under the Apache License, Version number 2.0. The license can be downloaded from: <https://github.com/aws/aws-sdk-android/blob/master/LICENSE.APACHE.txt>. The source code for this software is available from <https://github.com/aws/aws-sdk-android>.
- Aws-android-sdk-iot which is licensed under the Apache License, Version number 2.0. The license can be downloaded from: <https://github.com/aws/aws-sdk-android/blob/master/LICENSE.APACHE.txt>. The source code for this software is available from <https://github.com/aws/aws-sdk-android>.
- Aws-android-sdk-s3 which is licensed under the Apache License, Version number 2.0. The license can be downloaded from: <https://github.com/aws/aws-sdk-android/blob/master/LICENSE.APACHE.txt>. The source code for this software is available from <https://github.com/aws/aws-sdk-android>.
- Nv-websocket-client which is licensed under the Apache License, Version number 2.0. The license can be downloaded from: <http://www.apache.org/licenses/LICENSE-2.0.html>. The source code for this software is available from <https://github.com/TakahikoKawasaki/nv-websocket-client>.
- bump.tech.glide which is licensed under the Apache License, Version number 2.0. The license can be downloaded from: <http://www.apache.org/licenses/LICENSE-2.0.html>. The source code for this software is available from <https://github.com/bump.tech/glide>.

- Jakewharton:butterknife which is licensed under the Apache License, Version number 2.0. The license can be downloaded from: <http://www.apache.org/licenses/LICENSE-2.0.html>. The source code for this software is available from <https://github.com/JakeWharton/butterknife>.
- Caverock:androidsvg which is licensed under the Apache License, Version number 2.0. The license can be downloaded from: <http://www.apache.org/licenses/LICENSE-2.0.html>. The source code for this software is available from <https://mvnrepository.com/artifact/com.caverock/androidsvg/1.2.1>.
- Glassfish:javafx.annotation which is dual licensed under the CDDL, Version 1.0, and the GNU General Public License, Version 2, June 1991, with the Classpath Exception. The licenses can be downloaded from: <https://javaee.github.io/glassfish/LICENSE>. The source code for this software is available from <https://javaee.github.io/glassfish>.
- CalligraphyXamarin which is licensed under the Apache License, Version number 2.0. The license can be downloaded from: <http://www.apache.org/licenses/LICENSE-2.0.html>. The source code for this software is available from <https://github.com/mikescandy/Calligraphy-xamarin>.
- Newtonsoft JSON.NET which is licensed under the MIT License. The license can be downloaded from: <https://github.com/JamesNK/Newtonsoft.Json>. The source code for this software is available from <https://github.com/JamesNK/Newtonsoft.Json>.
- MaterialChips which is licensed under the Apache License, Version number 2.0. The license can be downloaded from: <http://www.apache.org/licenses/LICENSE-2.0.html>. The source code for this software is available from <https://github.com/DoodleScheduling/android-material-chips>.
- Android Open Source Project (“AOSP”), which is licensed under the Apache License, Version number 2.0. The license can be downloaded from: <http://www.apache.org/licenses/LICENSE-2.0.html>. AOSP also contains the Linux kernel which is licensed under GNU General Public License, Version 2, June 1991 (“GPL”). The license can be downloaded from: <http://www.gnu.org/licenses/gpl-2.0.html> Copyright © 1989, 1991 Free Software Foundation. For up to three years from PBI’s distribution of this product, you may obtain a complete machine-readable copy of the source code for the Linux kernel under the terms of the GPL, without charge except for the cost of the media, shipping, and handling, upon written request to PBI. Such requests should be sent by e-mail to iptl@pb.com.
- This product contains Paho.mqtt.java, which is licensed under the Eclipse Public License - v 2.0 and the Eclipse Distribution License - v 1.0. The licenses can be downloaded from <https://www.eclipse.org/legal/epl-2.0/> and <https://www.eclipse.org/org/documents/edl-v10.php>, respectively. The modified source code can be downloaded from: <https://github.com/PitneyBowes>.



3001 Summer Street
Stamford, Connecticut 06926
www.pitneybowes.com

SV63317-enca Rev.A
©2024 Pitney Bowes Inc.
All Rights Reserved