

Stand-Alone Desktop Printer

Installation Instruction

USB Printer Connection

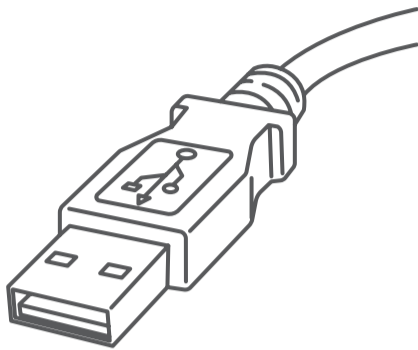

Read Now BEFORE you unpack your equipment

Continue reading below



Let's get your Desktop Printer up and running quickly...

Let's first get together the things you will need:

- The box containing your Desktop Printer.
- A PC on which you have full admin rights to allow downloading and installing software, if necessary.
- 1 available USB port on your PC.

1. Opening the box and unpacking.

Here's a diagram and explanation of the items you should find in your box.

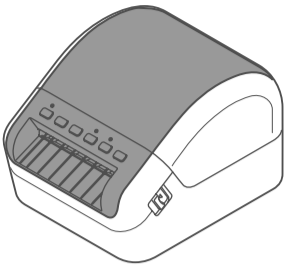

Printer

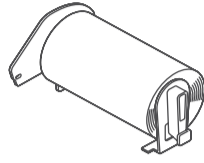

DK Starter Roll



Power Cord

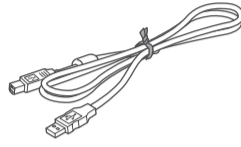

USB

Printer control panel buttons

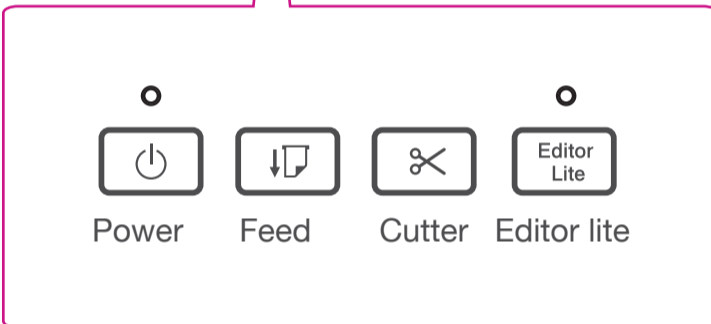
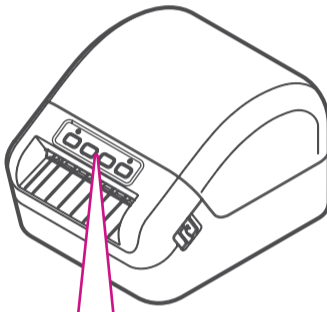

2. Connecting the printer.

Connect the power cord to your printer (as shown). Make sure the printer is still turned off.

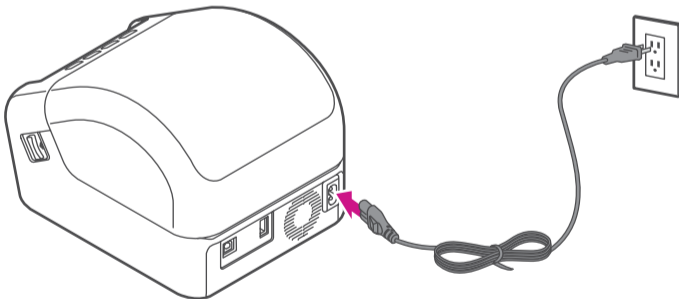

3. Loading the DK roll.

1. Pull the release levers on both sides of the printer to unlock the cover, and lift the cover to open it.

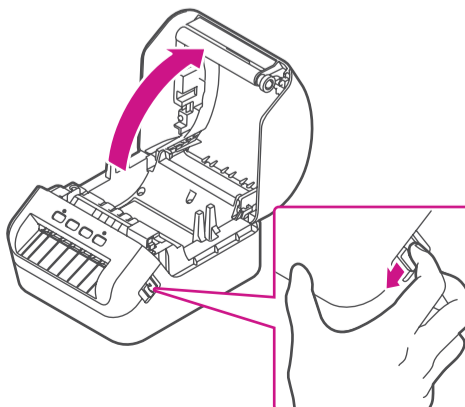

2. Remove the protective sheet from the output slot.

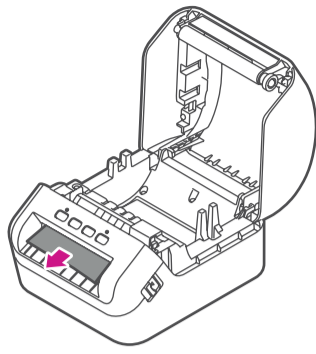

3. Place the DK roll into the guide.

Make sure the roll is inserted firmly in the guide and the stabilizer slides into the notch in the printer

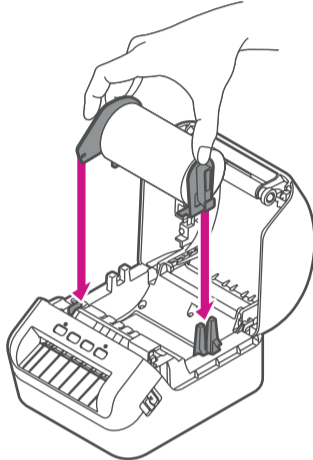

4. Thread the DK roll through the printer.

Align the edge of the DK roll with the upright edge of the output slot.

Check that the DK roll is threaded straight.

Push the first label through the output slot until the end comes out of the slot as shown.

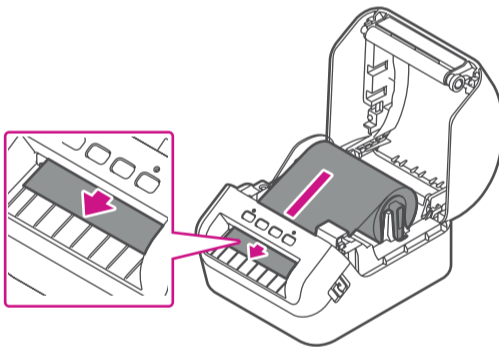

If experiencing trouble loading the label roll, try inserting from the side making sure the label is under the sensor.

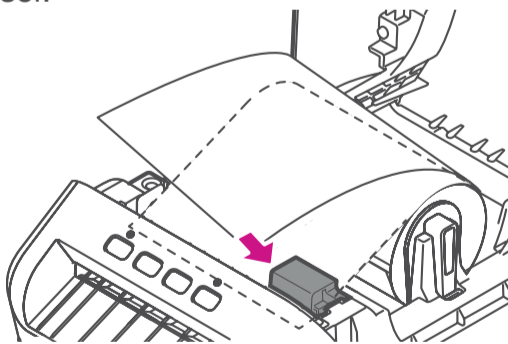

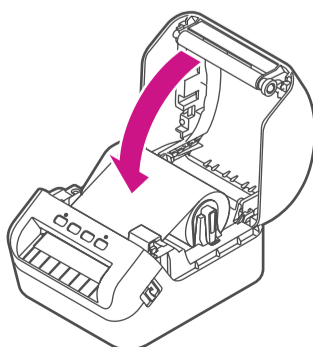

5. Close the cover.

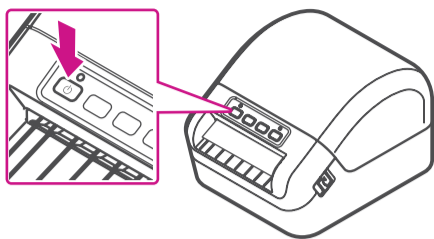

4. Turn power on.

Press the power button  to turn the printer on, and check the status LED turns green.



Make sure to press the feed button  to align the end of the DK Roll.

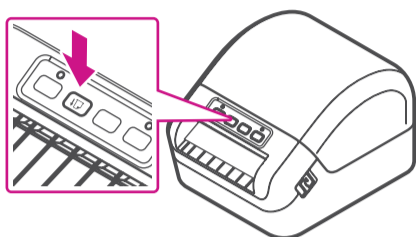

6. Install QL-1100 printer drivers on a computer

1. Visit URL [install.brother](https://install.brother.com) to download the Software/ Documentation Installer for the latest drivers, software and manuals. Accept the agreement and click Download.
2. Double-click the downloaded EXE file (for Windows) or DMG file (for Mac), and follow the on-screen instructions to proceed with the installation.

Note: You may need to check your downloads folder to install the downloaded file.

3. Close the dialog box when the installation is complete



Troubleshooting

Problem	Solution
The Status LED is not lit.	<ul style="list-style-type: none">• Check that the AC Power Cord is inserted. If it is inserted correctly, try plugging it into another AC power outlet.
The Printer does not print, or a printing error is received.	<ul style="list-style-type: none">• Check that the USB Cable is connected securely.• Remove the DK Roll and reinsert it.• Check that there is enough roll remaining.• Make sure that the DK Roll Cover is closed.• Turn off the Printer and then turn it on again. If there is still a problem, contact Pitney Bowes support.• If the Printer is connected via a USB hub, try connecting it directly to the computer. If not, try connecting it to a different USB Port.
A data transmission error appears on the computer.	<ul style="list-style-type: none">• Check that the correct port is selected from the “Print to the following port” list in the Printer Properties dialog box.• Wait until the Status LED stops flashing and then try printing again.
The label is not ejected correctly after printing.	<ul style="list-style-type: none">• Check that the Label Output Slot is not blocked.• Check that the DK Roll is set correctly by removing the DK Roll and reinstalling it.• Ensure that the DK Roll Cover is closed correctly.
Labels are jammed in the cutter.	<ul style="list-style-type: none">• Contact Pitney Bowes Customer Service.
Cutter error	<ul style="list-style-type: none">• If a cutter error occurs, keep the DK Roll Cover closed and press the Power Button. The cutter moves back to the normal position and the Printer turns off automatically. After the Printer is Off, check the Label Output Slot and remove any jammed labels.
Unable to reset an error.	To reset an error: <ol style="list-style-type: none">1. Open the DK Roll Cover, and then close it.2. If the error is not reset, press the Cutter Button.3. If the error is not reset, turn off the Printer, and then turn it on again.4. If the error is not reset, contact Pitney Bowes Customer Service.

If you're still having trouble, then visit pitneybowes.com/ca/en/ql-1100 and select Errors & Troubleshooting.



* A W 3 2 8 3 9 R E V A *

AW32839 Rev. A 12/18
©2018 Pitney Bowes Inc.
All Rights Reserved

pitney bowes 

5500 Explorer Drive
Mississauga, ON L4W 5C7
www.pitneybowes.com/ca/en