

Read Me First!

pitney bowes 



Shipping and Mailing
Franking Machines

Digital Mailing System DM100i and DM200i series

Your new system has been designed to let you set it up on your own, so you can begin processing mail in just a short time.

It is important that you carefully read and follow the sequence of steps in this guide to successfully install this product.



Quick Install Guide
UK Version

Before you begin...

• Check that you have the following:

Mailing Machine

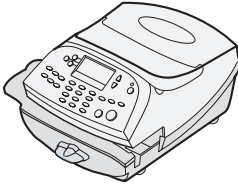

Ink Cartridge



Sealing solution
(only if moistener supplied)



Print Head
(in its plastic packaging)

Moistener
(some models)

Operating Guide

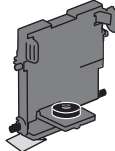

Stacker

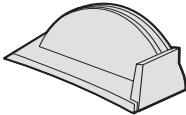

Label Sheets



Power Cord



Weighing Platform

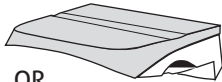

OR

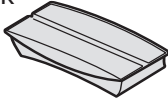

USB Cable

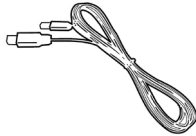

Base Unit/Drawer
(some models)

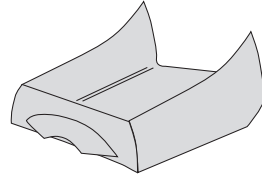

• Check that the Mailing Machine 'Meter #' matches the meter number on the side of the packaging:

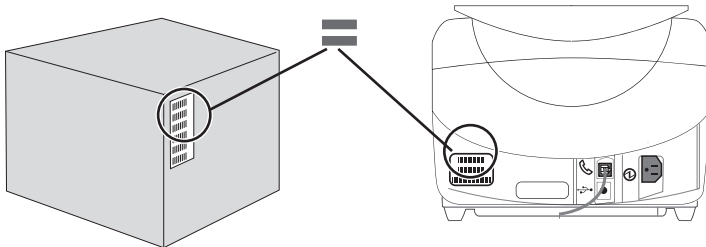

If the numbers do not match, **contact Pitney Bowes immediately** and do not continue with the steps in this guide.

Step 1 Please do not apply power to your machine until instructed to do so.

**Remove all shipping tape attached to your meter.
Be sure to open the top cover and remove inside shipping tape.**

Choose a location for your system where it can remain plugged in and turned ON at all times. Also, locate the system so that it can be plugged into your Smartlink device or an internet enabled PC. This is essential for refilling the machine with postage.

Installation requires contact with our Data Centre which is open from 7am to 8pm Monday to Saturday including Bank Holidays. **Please do not attempt to install your system outside these times.**

On models with a base unit, place the Mailing Machine onto the base unit now.

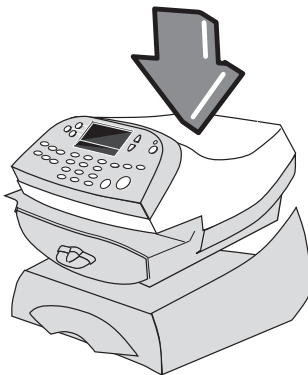

Step 2 Connection Method

You have to connect to the Pitney Bowes Data Centre to add postage funds, get software updates, and perform required Postal Authority inspections.

Pitney Bowes recommend connecting via a **Smartlink Communication Device**. Smartlink provides a fast, constant connection. If you are connecting via a purchased **Smartlink** device please go to **[pitneybowes.com/uk/smartlinksetup](https://www.pitneybowes.com/uk/smartlinksetup)**.

Once you have completed setup please return to Step 3 on the next page.

If you would like to learn more about the Smartlink connection method. Please contact your Pitney Bowes supplier.

Step 2 Connection Method (continued)

An alternative connection method is connection using PC Meter Connect™ which uses a connection via your PC. If you have connected via Smartlink please proceed to **Step 3**.

- To install PC Meter Connect™, go to...

europe.pb.com/PCMeterConnect/setup.exe

Choose the '**Run**' option to install the software and be sure to select '**English (UK)**' as your installation language. You will need administrator rights on your PC to install the software.

When the software is installed, continue with **Step 4** of this guide.

Step 3 Connect to the Power

If you haven't already connected your system to the power during connection device setup, plug the power cord into a convenient outlet and into the machine.

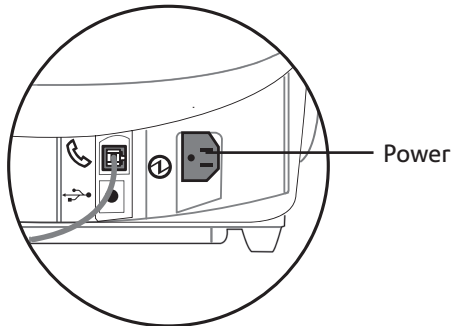

WARNING:

As no on/off switch is fitted, the power cable is the primary disconnect. The power cable should be in such a position that access may be gained to disconnect the machine.

Always plug the equipment into a properly grounded wall outlet.

The socket outlet should be near the equipment and should be easily accessible.

Use the mains lead supplied with your equipment.

Step 4 Set Time

After powering on your machine, you will need to set the time. Key in the hour (in 24 hour format), then select **Continue** to confirm.

Key in the minutes, then select **Continue** to confirm.

Check the displayed time and, if correct, select **OK**.

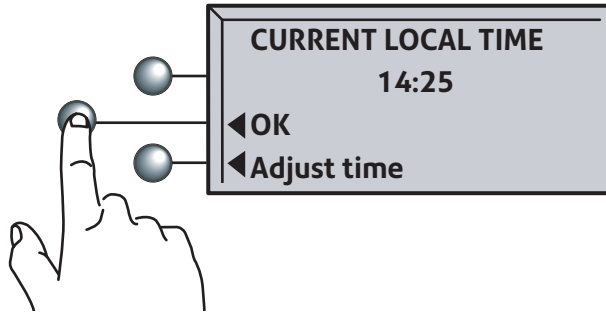

The time shown must be correct for UTC/GMT/'winter time' and **will be 1 hour behind in summer**. This can be adjusted after the installation, if necessary, using the 'Daylight Savings Time' feature described in the Operating Guide.

Step 5 Install the Print Head

The following screen will appear.

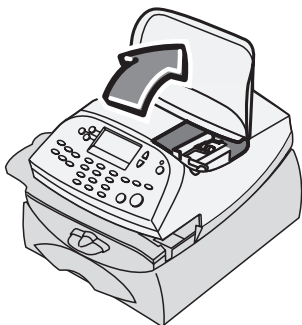

Print head not detected. Open cover to install print head and ink tank.

A Open the top cover.

B Flip open the guard.

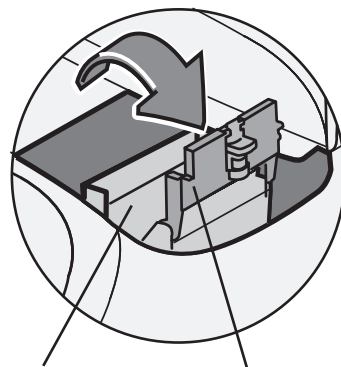

Print head cavity

Ink cartridge guard

Step 5 Install the Print Head (continued)

- C** Remove print head from packaging. **DO NOT** touch the contacts on the print head.

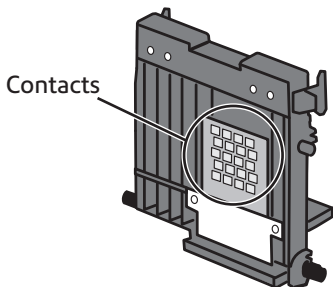

- D** Remove tape strip from print head.

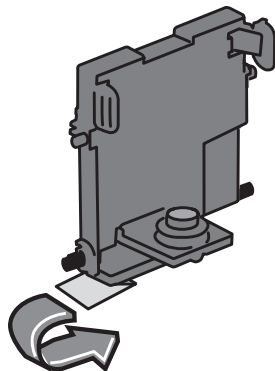

- E** Slide the print head pegs down into the grooves.

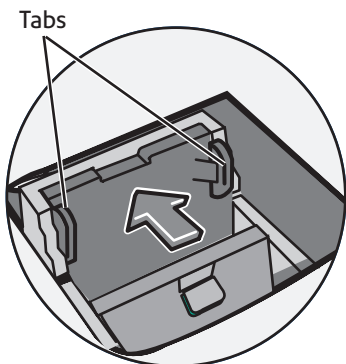
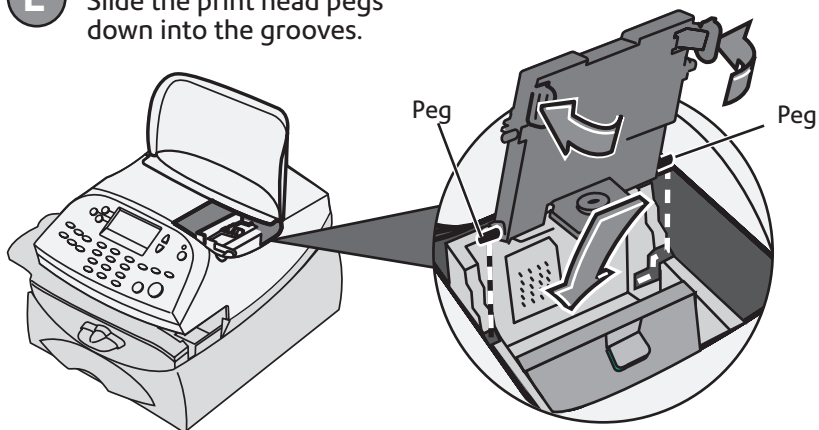

- F** Squeeze the tabs on the sides of the print head and push the print head flush against the wall.

Step 6 Install the Ink Cartridge

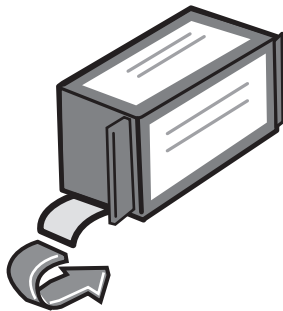

- A** Unwrap the new ink cartridge. Make sure that the tape on the bottom of the cartridge is removed if it doesn't come away with the wrapping.

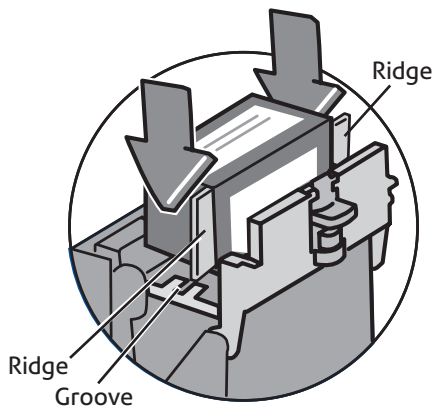

- B** Lower the cartridge into the cavity. The ridges on either side of the cartridge will slide into the grooves.

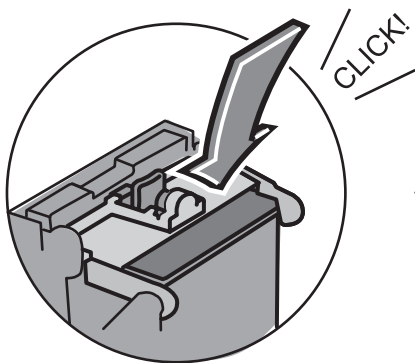

- C** Return the guard back to the operating position and click to close.

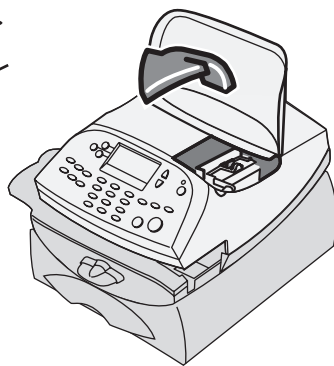

- D** Close the cover. The system will automatically start the printer installation, which takes a few minutes. Continue with step 7 overleaf while the printer installation takes place.

Step 7 Create a Test Pattern

When prompted, insert a spare envelope or a tape sheet for a test print.

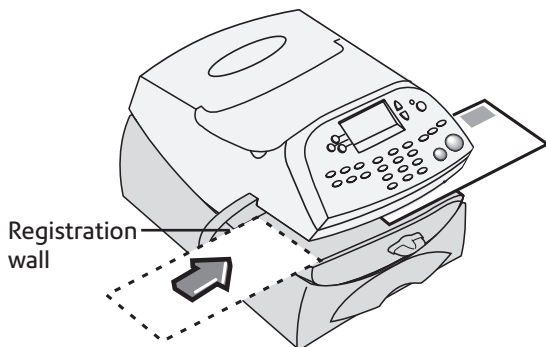

To print correctly, position mail flush against rear registration wall and gently slide mail to the right on feed deck.

The system will detect the envelope and automatically guide it through the printing mechanism.

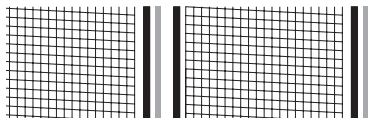

Good test print - no missing lines

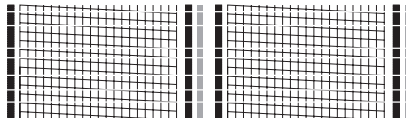

Poor test print

If the test print is good, press **Yes** on control panel.

If the test print is poor, press **No** to perform additional maintenance.

No



Yes/Enter



Step 8 Check Your Account Balance

Your system will automatically connect to the Postage By Phone Data Centre and after a brief delay, display your Postage By Phone balance.

- Select **Continue**.

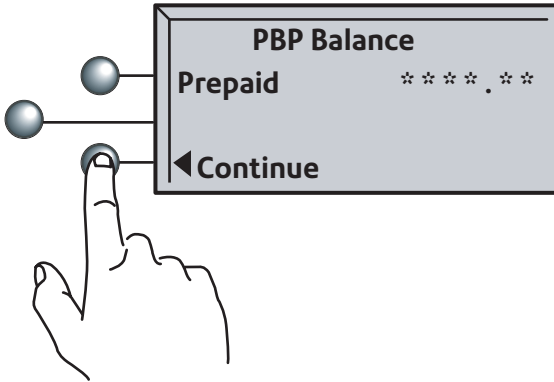

Step 9 Load Postage Into Your System

Key in the amount of postage you wish to add. Amount must be in £50 increments.

- Select **Continue**.

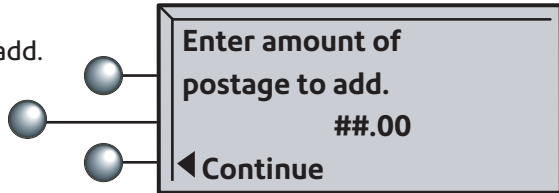

- Press **Yes** to confirm.

Yes/Enter

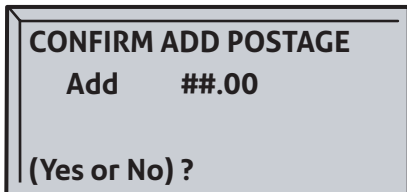

Information screens will appear.

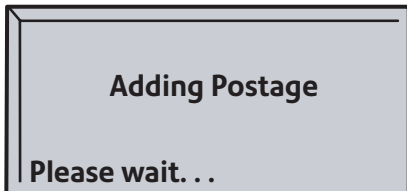

Step 9

Load Postage Into Your System (continued)

- Press **Yes** to print a receipt.

Yes/Enter

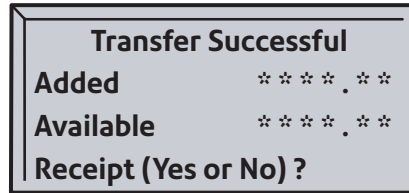

Follow the display directions.

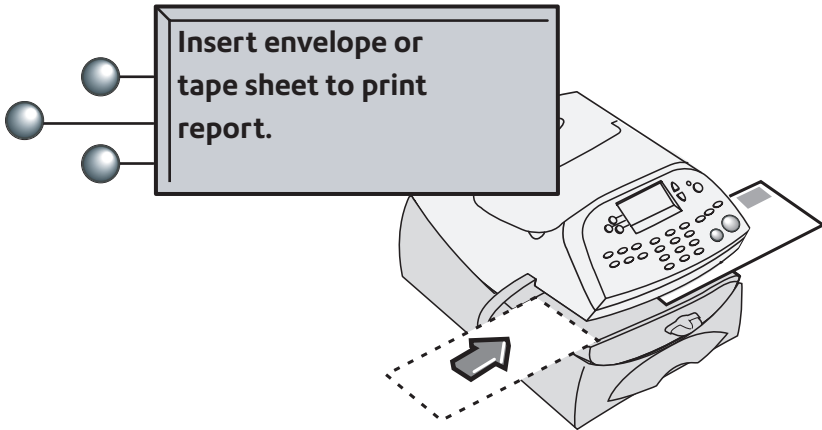

Check that the Postage by Phone account number printed on the receipt matches the account number on the despatch note received with the system. The numbers should match, if they don't, **contact Pitney Bowes before using the system.**

Step 10 Update software

 **NOTE:** You will be informed that a system software update is available.

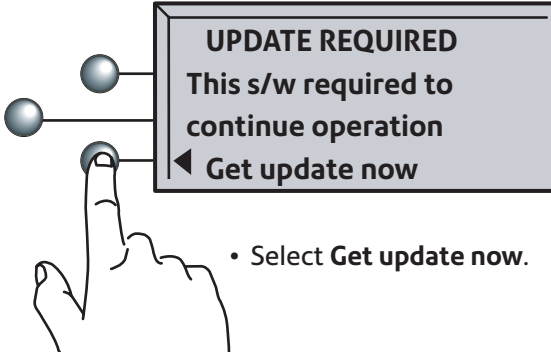

Any additional features and options that you selected as part of your order will take a few minutes to download.

- Select **Continue**.

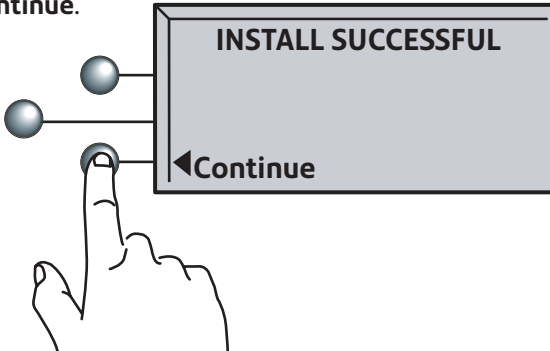

Step 11 Install Weighing Platform

Your system is now installed, but you must still fit and configure the weighing platform.

- Select **OK**.

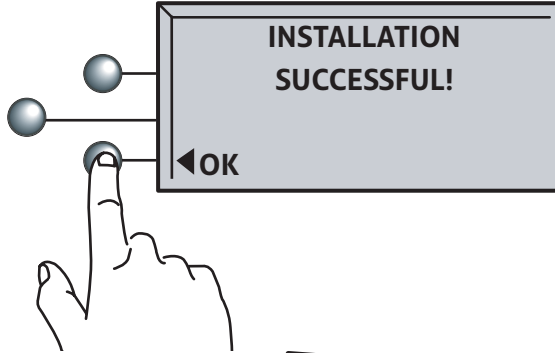

Position the weighing platform as shown. Plug the connector on the weighing platform into the matching connector on the machine.

Note that some models have a smaller platform than the one illustrated.

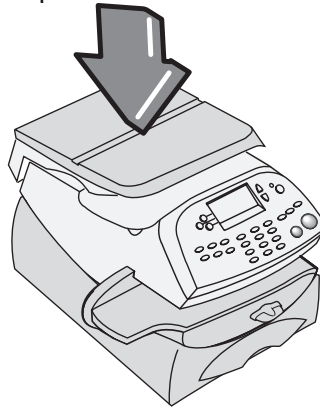

Key in the correct scale code for your location from the map below

- Select **Continue**.

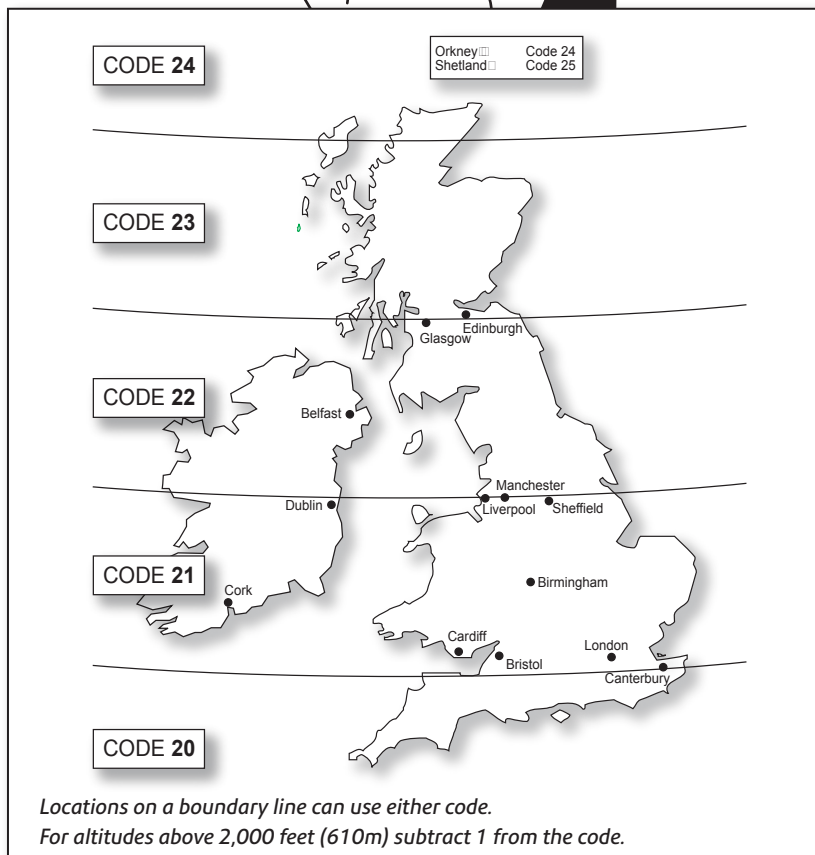
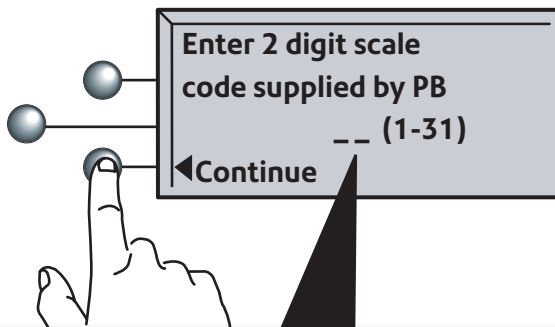

Your system is ready to use. To learn all about using your machine, see the Operating Guide.

Chapter 3 describes how to run mail.

Chapter 4 describes setting up the Normal Preset so that your machine automatically loads your 'standard' settings, including your preferred Envelope Messaging, etc.

If you are currently on Daylight Savings/Summer Time, refer to Chapter 6 to advance the system's internal clock by 1 hour.

Install Additional Components

Install any other items supplied with your machine:

Moistener

If you have a moistener unit with your machine, position the moistener on the left side of the transport deck as shown.

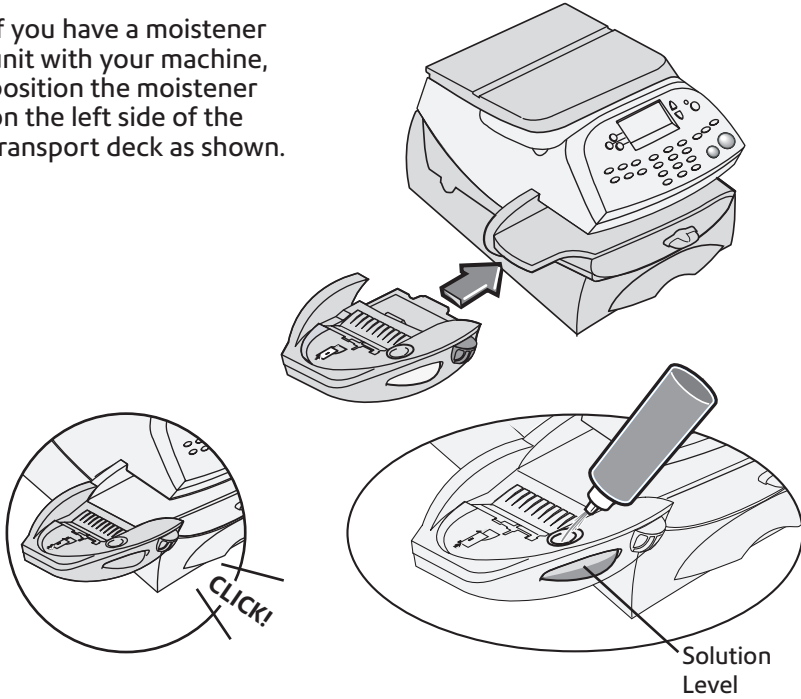

The moistener will click into place.

Fill the moistener reservoir with sealing solution. You may fill it later if you don't plan to moisten and seal envelopes immediately.

Stacker

Position the stacker next to the machine as shown.

The stacker provides a convenient location to store your operator guide.



Troubleshooting

Cannot Reach Data Centre -

If you are using Smartlink, make sure that the cables are connected correctly and that the lights are showing ready.

If you are using PC Meter Connect™, make sure the USB cable is connected between the mailing system and PC and that the PC can connect to the internet.

Not Enough Funds -

You have tried to add more postage than you have in your Postage by Phone account.

To change information entered during setup -

- Press the Clear key on the numeric keypad.
- At the 'Install Not Complete' message, either go back to the previous step or return to the Install Start.

If you still have problems...

- Refer to the troubleshooting section in the Operating Guide.
- Refer to our support website:
www.pitneybowes.com/uk and select Support
- You can also telephone one of our specialists for advice on:
09068 181 181 Calls charged at 60p per minute



PB Form SDC569G (10-16)

© Pitney Bowes Limited, 2016

We have made every reasonable effort to assure the accuracy and usefulness of this guide, however we cannot assume responsibility for errors or omissions or liability for the misuse or misapplication of our products.



★ S D C 5 6 9 G ★