

*Conveyor  
Stacker*

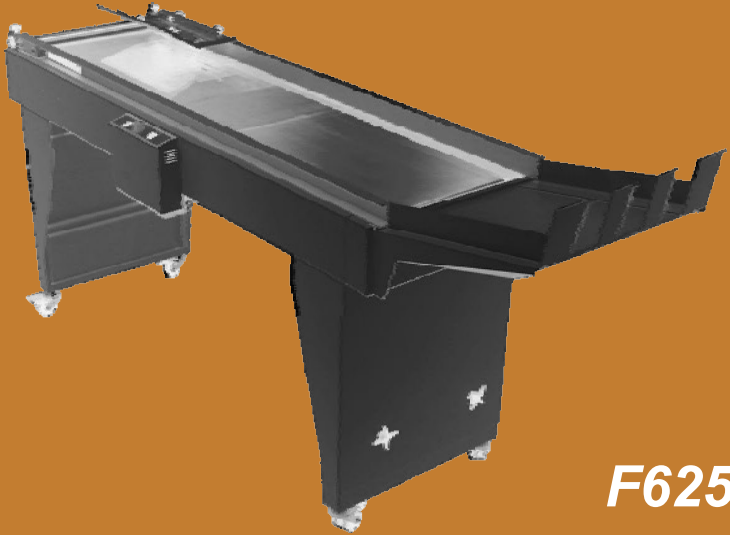

**F625**

## **CONTENTS**

Before setting up and using the F625, you should be thoroughly familiar with its controls and setup procedure. You should also be thoroughly familiar with each component of the Inserting system the F625 is being used with.

This Guide is organised into three sections:

### **1. INTRODUCTION**

Gives basic details of your F625. This section includes:

**page**

1.1	Safety.....	2
1.2	What the Conveyor Stacker Does .....	3
1.3	Main Components.....	3
1.4	The Control Panel.....	6
1.5	Principle of Operation .....	6

### **2. OPERATION**

Gives the basic steps required to process documents. It explains:

#### **Use with the DI800**

2.1	Setting up for operation with the DI800 Inserter.....	7
2.2	Operation with the DI800 Inserter .....	9
2.3	Setting up for DI800 and optional In-Line Kit .....	11
2.4	Operation with the DI800 and optional In-Line Kit.....	12

#### **Use with the DI875**

2.5	Setting up for operation with the DI875.....	13
2.6	Operation with the DI875.....	15
2.7	Setting up for DI875 and optional In-Line Kit.....	17
2.8	Operation with the DI875 and optional In-Line Kit.....	18

### **3. REFERENCE**

Covers subjects that may only be required occasionally. It includes:

3.1	Troubleshooting .....	19
3.2	Service.....	19
3.3	Specifications .....	20

# Introduction

---

## 1. INTRODUCTION

### 1.1 Safety

#### **General**

- Know your equipment, especially **how to stop it in the event of an emergency**.
- Never reach into the machine while it is on; always wait until the machine has come to a full stop.
- Never touch moving parts.
- Keep fingers, long hair, jewellery and loose clothing away from moving parts at all times.
- Use the equipment only for its intended purpose.
- Don't remove machine covers. Refer servicing to qualified personnel.

#### **Mains Electrical Connection**

In some countries the F625 is supplied with a moulded mains lead. In other countries, or if the supplied lead is not used, the following information applies:

1. An approved mains lead for the country concerned must be used.
2. The wires in the supplied mains lead are coloured in accordance with the following code:  
Green and Yellow - Earth  
Blue - Neutral  
Brown - Live
3. As the colours of the wires in the mains lead of this equipment may not correspond with the coloured markings identifying the terminals in your plug, proceed as follows:

The wire which is coloured green and yellow must be connected to the terminal in the plug which is marked with the letter "E" or by the earth symbol  or coloured green or green and yellow.

The wire which is coloured blue must be connected to the terminal which is marked with the letter "N" or coloured black.

The wire which is coloured brown must be connected to the terminal which is marked with the letter "L" or coloured red.

<p style="text-align: center;"><b>WARNING:</b></p> <p style="text-align: center;">This equipment must be earthed. The socket outlet should be near to the equipment and should be easily accessible.</p>
--

## 1.2 What the Conveyor Stacker Does

The Model F625 Conveyor Stacker is a belt stacker designed as output device for the DI800 and DI875 inserting systems, but also as general output device for other machines.

The Conveyor Stacker operates at a right or left angle and also in-line with optional parts. The product can easily be changed over without any tools. The control panel, which can be hooked up on either side of the stacker, incorporates variable speed control, run-out button, power switch and power supply.

## 1.3 Main Components

Take a few minutes to become familiar with the components of the Conveyor Stacker.

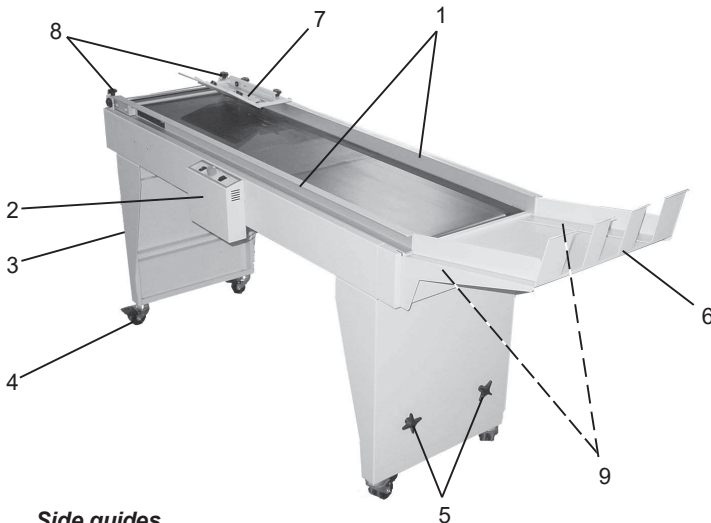

- 1 Side guides**
- 2 Control panel box**
- 3 Leg assembly**
- 4 Lockable castors**
- 5 Height adjustment knobs**
- 6 Stacking tray**
- 7 Entry guide**
- 8 Front end side guide adjustment knobs**
- 9 Rear end side guide adjustment knobs (underneath, not visible)**

# Introduction

---

## 1.3 Main Components (Continued)

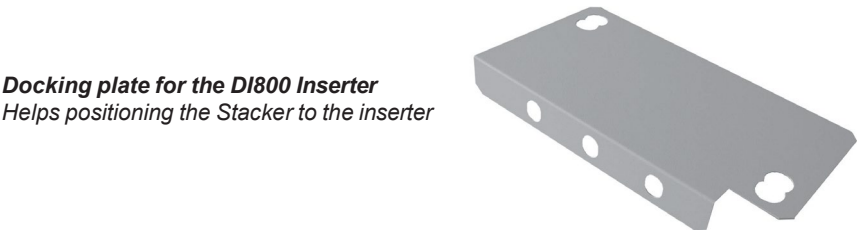
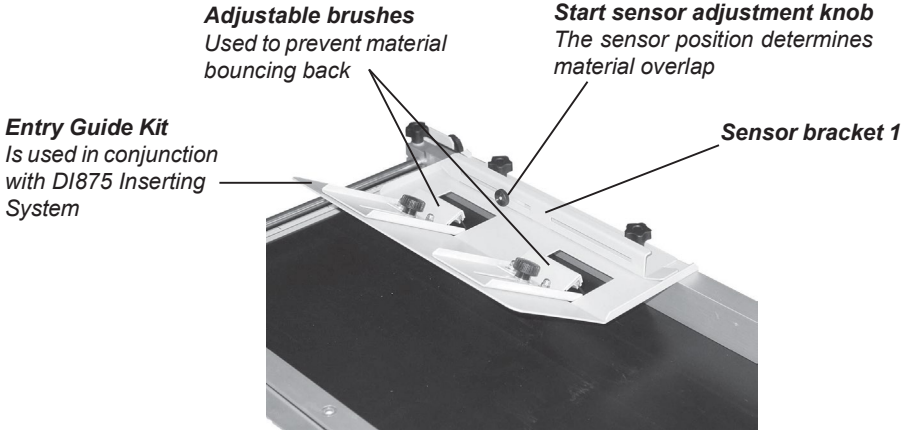

# Introduction

---

## **Optional In-line Kit**

The In-Line Kit is used when the material enters the Conveyor Stacker at the short end. This is the preferred configuration when running heavy, large envelopes.

**Start sensor adjustment knob**  
The sensor position determines material overlap

**Sensor bracket 2**

**Idler roller position adjustment knob**

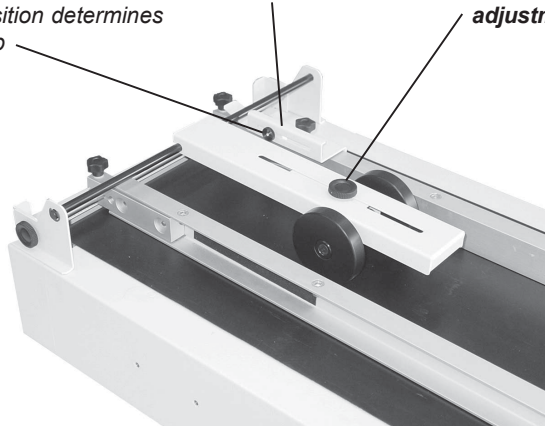

## **Optional Low-Profile Feet**

Lowers the unit by 60 mm ( $2\frac{3}{8}$ " ). The Low Profile Feet replace the castors.

The kit contains four feet, for one Conveyor Stacker.



# Introduction

---

## 1.4 The Control Panel

The control panel can be positioned either side of the unit, depending on system configuration.

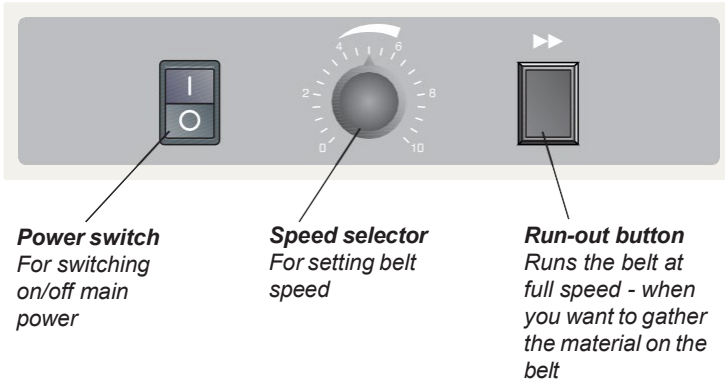

## 1.5 Principle of Operation

The belt will start as soon as the Start sensor is covered. When the material has moved out of the sensor area the belt will stop again. The Start sensor position is adjustable, which allows the material overlap to be adjusted.

The speed of the belt can be adjusted in order to optimise the stacking function for various materials.

The Run-out button is used to gather the material after a job is finished. The belt moves at the highest speed, independent of the Speed Selector setting.

## 2. OPERATION

### 2.1 Setting up for operation with the DI800 Inserter

1. Place the Docking plate under the DI800 Inserter. The feet should go through the oblong cut-outs and position the plate correctly.

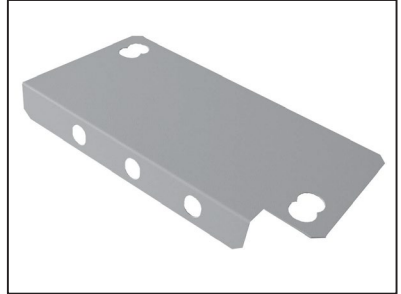

2. The plate should be in the inner position for 90 degree operation. Lift the inserter slightly to be able to position the plate.
3. For right hand stacker configuration the two studs of the Conveyor Stacker should be positioned into the two holes (A) and vice versa.

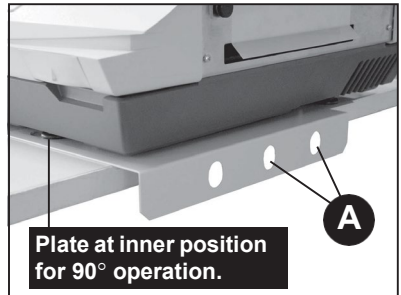

This illustration shows the Conveyor Stacker correctly docked to a DI800 Inserter.





# Operation

## 2.1 Setting up for operation with the DI800 Inserter (Cont'd)

4. Check the correct height of the Stacker. Place the Stacker close to the Inserter and check whether the studs on the side of the Stacker fit into the openings in the Docking plate. If not, loosen the height adjustment knobs **(B)** and readjust.

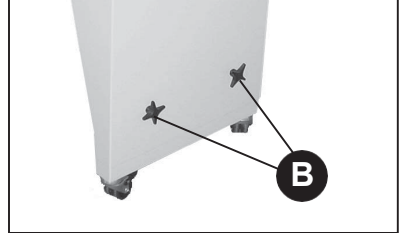

5. Position the Conveyor Stacker as close to the inserter as possible and lock all four castors.

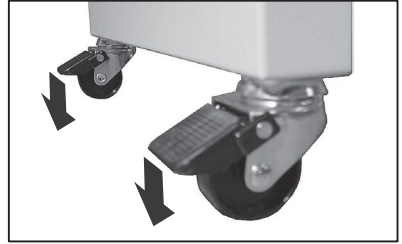

6. Loosen the front and rear end knobs **(C)** of the side guide closest to the inserter output and move the side guide as close as possible to the inserter. (The picture shows the inserter removed for clarity).

Retighten the front and rear end knobs.

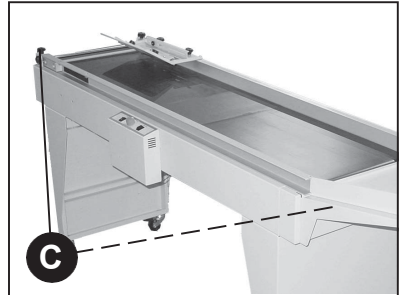

7. Install the rear support **(D)**.
8. For right hand operation; install the Sensor and Sensor Bracket **(E)** as shown in the picture.

For left hand operation the parts are installed mirrored.

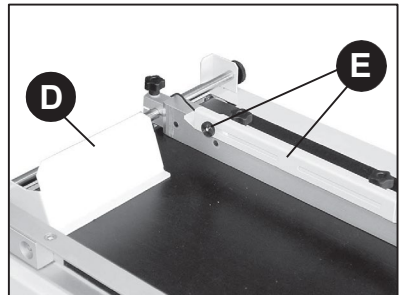

- Loosen the two knobs **(F)** on the inserter and move the deflector to its top position.

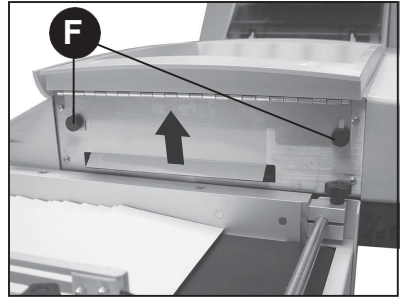

## 2.2 Operation with the DI800 Inserter

- Place one envelope on the belt.
- Loosen the front and rear end side guide knobs **(A)** of the side guide with the sensor bracket only.

***Make sure the side guide rests on the belt!***

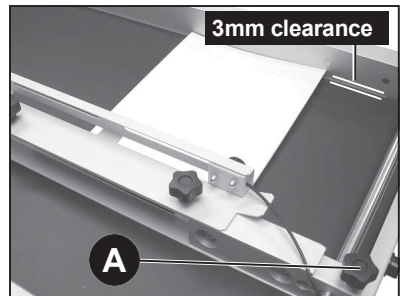

- Adjust the side guide to give a clearance of about 3mm (1/8") and retighten the front and rear end side guide knobs.

***Make sure the side guides are parallel!***

- Read the safety information on page 2, then connect the Conveyor Stacker to the mains supply and turn ON.
- Set the belt speed to maximum.



# Operation

---

## 2.2 Operation with the DI800 Inserter (Continued)

6. Start the DI800 system.
7. Adjust the envelope overlap by moving the Start sensor. When the sensor is moved away from the inlet the distance between the envelopes will be larger, and vice versa.

***Keep the step as small as possible without envelopes building up too much. That way you can optimise the belt capacity!***

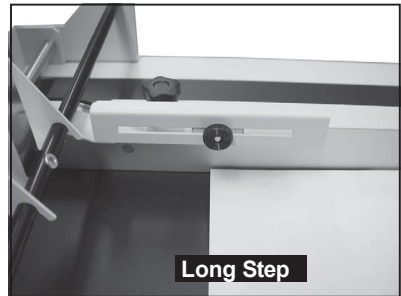
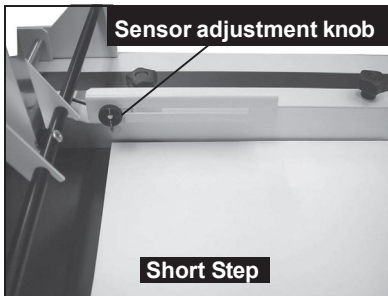

8. Reduce the belt speed until the motor runs continuously.

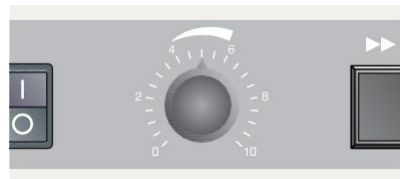

## 2.3 Setting up for DI800 and optional In-Line Kit

1. The docking plate should be in the outer position for in-line operation. Lift the inserter slightly to be able to position the plate.

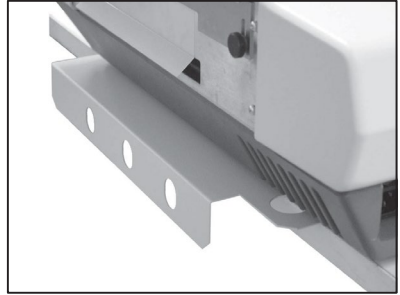

2. Remove the deflector from the Inserter by loosening the two knobs (A).

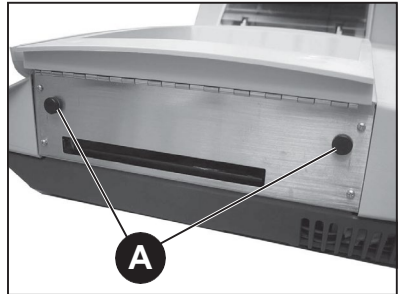

3. Position the Stacker as illustrated. The upper outer corner of the left Side Guide should be aligned with the lower left output corner of the Inserter.

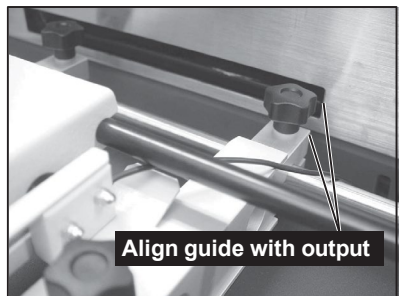

# Operation

---

## 2.4 Operation with DI800 and optional In-Line Kit

Basic setting of side guides for DL size envelopes.

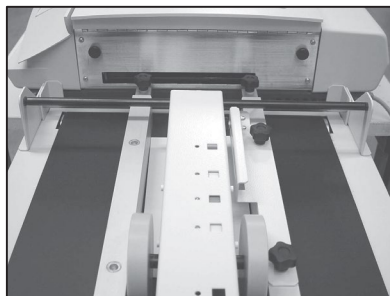

Basic setting of side guides for C5 size envelopes. Only the right hand side guide needs to be moved when changing format.

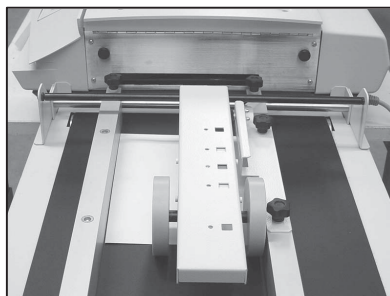

Adjust the wheel position; place an envelope with the trailing edge underneath the black shaft, slide the wheels so that they align with the leading edge of the envelope.

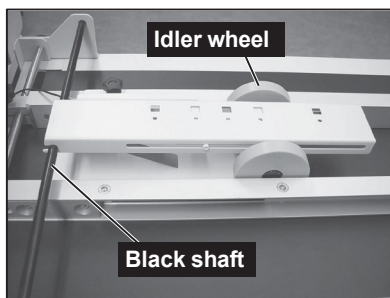

See Section 2.2 for overlap and speed settings.

## 2.5 Setting up for operation with the DI875

1. Install Entry Guide Kit, Sensor Bracket 1 and Sensor as shown in the picture. For right hand orientation, install the parts mirrored.

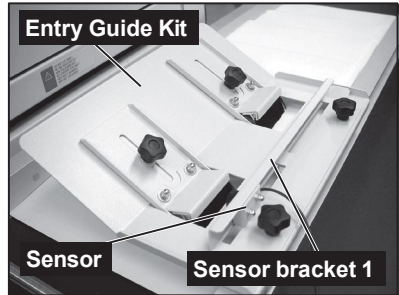

2. Check the correct height of the Stacker. Place the Stacker close to the Inserter and check whether the docking studs on the side of the Stacker fit into the cut-out on the inserter.

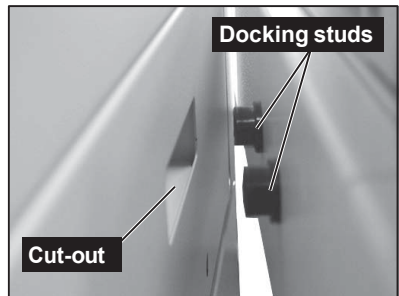

If not, loosen the height adjustment knobs **(A)** and readjust.

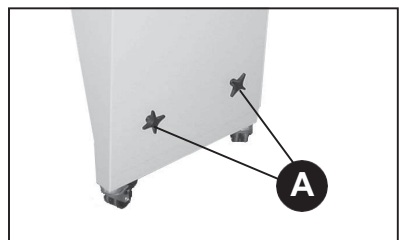

3. Position the Stacker as close to the inserter as possible and lock all four castors.

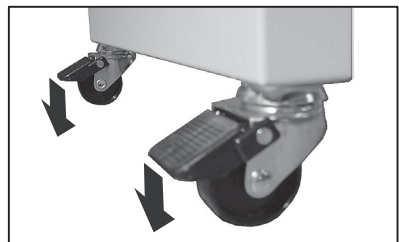

# Operation

---

## 2.5 Setting up for operation with the DI875 (Continued)

4. Make sure the Exit roller shaft is installed on the inserter.



5. Loosen the front- and rear end knobs and move the side guide as close as possible to the inserter

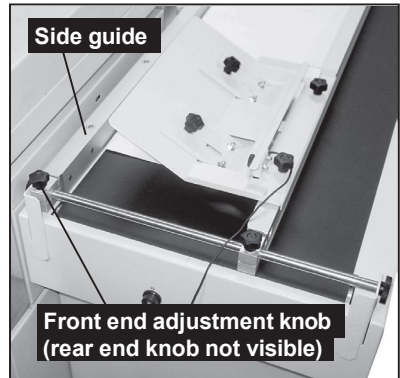

## 2.6 Operation with the DI875

1. Place one envelope on the belt.
2. Loosen the front and rear end side guide knobs (A) of the side guide with the sensor bracket only.

***Make sure the side guide rests on the belt!***

3. Adjust the side guide to give a clearance of about 3mm (1/8") and retighten the front and rear end side guide knobs.

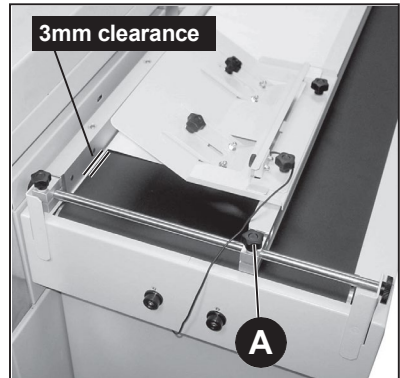

***Make sure the side guides are parallel!***

4. Loosen the Brush adjustment knobs (B) and set the brush position on the Entry guide. The brushes should just about touch the envelope. Retighten the adjustment knobs.

The setting depends on envelope size, thickness, inserter speed and belt speed.

If the brushes are set too tight the envelopes will not get in position.

If the brushes are set too loose the envelopes could bounce back and cause jams.

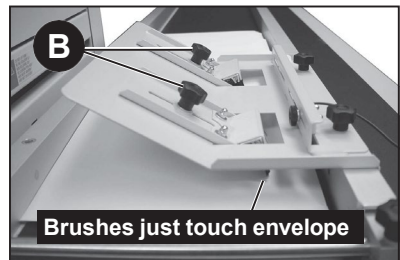

5. Read the safety information on page 2, then connect the Conveyor Stacker to the mains supply and turn ON.
6. Set the belt speed to maximum.





# Operation

## 2.6 Operation with the DI875 (Continued)

7. Start the DI875 system.
8. Adjust the envelope overlap by moving the Start sensor. When the sensor is moved away from the inlet the distance between the envelopes will be larger, and vice versa.

***Keep the step as small as possible without envelopes building up too much. That way you can optimise the belt capacity!***

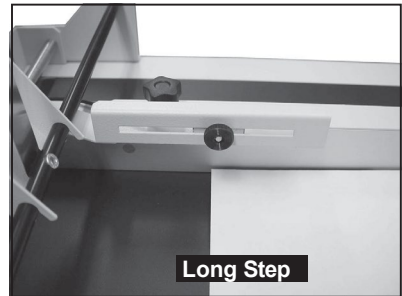
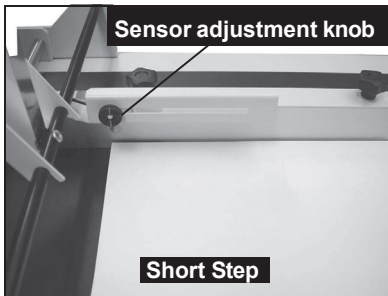

9. Reduce the belt speed until the motor runs continuously.

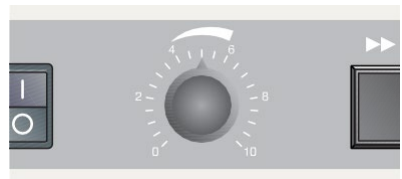

## 2.7 Setting up for the DI875 and optional In-Line Kit

1. Install Sensor Bracket 2, Start sensor and Idler roller assembly as illustrated.

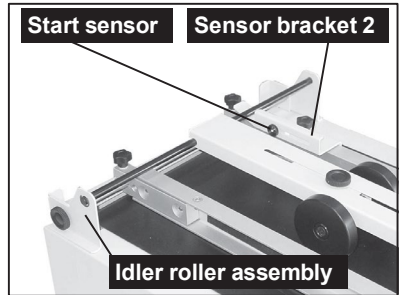

2. Adjust the Stacker height so that the docking studs can enter the cut-out in the DI875 output end.

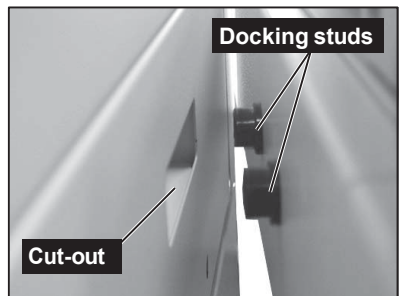

3. Place the Stacker as close to the inserter as possible and lock all four castors.

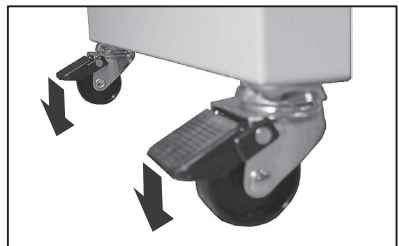

# Operation

---

## 2.8 Operation with the DI875 and optional In-Line Kit

1. Place one envelope on the belt.
2. Centre the side guides around the middle, approx. 6mm (1/4") wider than the envelope. Use the front and rear scales to simplify the centring.
3. Adjust the idler wheel position; place an envelope with the trailing edge under the black shaft, slide the idler wheels so that they align with the leading edge of the envelope.

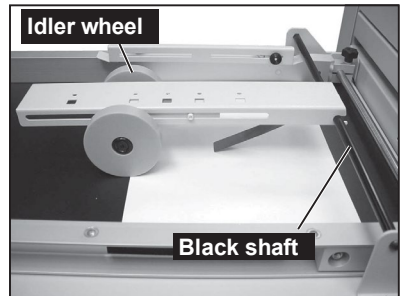

4. See Section 2.6 for overlap and speed settings.

## 3. REFERENCE

### 3.1 Troubleshooting

Symptom	Possible cause	Remedy
Material gets stuck in the inlet area	Entry guide brushes set too tight/ low (DI875 only)	Readjust brushes upwards
	Belt speed too low, material builds up and gets stuck	Increase belt speed
	Step length too small	Increase step length
	Side guides set too narrow	Adjust side guides
	The incoming envelope catches on the previous envelope's window	Increase belt speed and step length, so that the incoming envelope won't hit the previous envelope window
Material doesn't transport all the way to the stacker end stacking tray	Material slips in underneath side guide and gets stuck	Loosen side guide knobs, press side guide down and tighten knobs
	Side guides too narrow or funneled	Check side guides are parallel and have correct clearance
Material topples over on the belt, even with low numbers of items	Step too big, material slips on belt because of insufficient weight	Reduce step length
	Step length too big	Reduce step, reduce belt speed
	Side guides not parallel or too tight	Check side guides are parallel and have correct clearance

### 3.2 Service

Pitney Bowes provides service throughout the world. Should you have questions about your F625 Conveyor Stacker, or require service or assistance with your particular application, please call Pitney Bowes or the dealer serving your area. The phone number will be on a sticker on your F625, and/or on the back cover of this guide.

A service maintenance contract is available to keep your F625 (as well as your entire Inserting system) in top condition at nominal cost. Contact Pitney Bowes or your dealer for details.

# Reference

---

## 3.3 Specifications

### Equipment Specifications:

<b>Standard Features</b>	Variable speed, Adjustable overlap of media, Clear-deck switch, Universal power inlet, Lockable castors on all four feet, Aligning studs for Inserter DI875, Docking plate for DI800
<b>Options</b>	In-line kit, Low-profile feet
<b>Capacity</b>	With a minimum insert in the envelope: C4 up to a maximum of 1,500 envelopes C5 up to a maximum of 2,500 envelopes DL up to a maximum of 1,200 envelopes
<b>Table Height</b>	Adjustable 635 – 792mm (the height can be reduced by 60mm with optional Low Profile Feet)
<b>Width</b>	440mm (incl. 50mm for control unit)
<b>Length</b>	1785mm (incl. end stacking plate 350mm)
<b>Weight</b>	58kg
<b>Power</b>	100-240VAC $\pm 10\%$ , 50/60 Hz, 1A Power consumption 70W Heat emission 70 Joule/s (240 Btu/hr)
<b>Compliance:</b>	 Pitney Bowes certifies that the F625 complies with the requirements of the Low Voltage Directive 73/23EEC and the EMC Directive 89/336/EEC

### Material Specifications:

The side guides are adjustable in between 115mm and 357mm.

We have made every reasonable effort to assure the accuracy and usefulness of this guide, however we cannot assume responsibility for errors or omissions or liability for the misuse or misapplication of our products.

**FOR SERVICE AND SUPPLIES:**



3001 Summer Street  
Stamford, Connecticut 06926  
[www.pitneybowes.com](http://www.pitneybowes.com)